

GRASSOLER

sofás desde 1960

Living Grassoler

Nuestro
valor...
nuestra
marca...



**New
collection**

Nueva
colección

Grassoler

EN · Grassoler is a leading Spanish company engaged in the manufacture of contemporary upholstered furniture, 100% made in Spain. Since its establishment in 1960 in Barcelona as a family business, we have been committed to innovation in design and offering the highest quality level in manufacturing our sofas.

Grassoler is located in Barcelona, where our facilities cover an overall area of 8.000 m² (86,000 sq.ft.) for offices and production with another 700 m² (7,500 sq.ft.) of showroom space.

The range of products offered includes contract, hospitality and residential. We have been exporting all over the world for over 38 years.

ES · La empresa Grassoler es una de las primeras firmas españolas, y la más antigua, dedicada en exclusiva al mueble tapizado, fabricado íntegramente en España. Desde su creación en 1960 en Barcelona, como empresa familiar apostamos por la innovación en el diseño y por la más alta calidad en la fabricación a la hora de producir nuestros sofás.

Situada en las afueras de Barcelona, nuestras diversas instalaciones actuales disponen de una superficie global de aproximadamente 8.000 m² destinadas a oficinas y producción y un showroom de 700 m².

La gama de productos abarca desde la instalación para todo tipo de colectividades hasta el canal hogar. Grassoler opera desde hace más de 38 años exportando a todo el mundo.



Established in 1960 in Barcelona

Desde 1960 en Barcelona

EN · In 1960, at the young age of 19, Jose Gras Soler established Grassoler in a small building in the center of Barcelona. A few years later, the company moved to its current location. 1963 was a banner year for Grassoler when the patented “Intelligent System®” was introduced in the market. This revolutionary modular metal frame spring system developed by Jose Gras launched Grassoler into becoming an industry leader in Spain and later throughout Europe and the rest of the world. It is well established and acknowledged as a culmination of excellence in design and ergonomics in achieving the highest level of performance and comfort, with built-in flexibility unique to the Grassoler brand.

ES · Fruto de la iniciativa de José Gras Soler, con 19 años, Grassoler, S.A. nació en 1960 como una pequeña estructura empresarial en un local del centro de Barcelona, que más tarde, en 1966 trasladó a las instalaciones actuales. El negocio empezó a crecer hacia 1963, año de lanzamiento del mayor éxito de ventas que ha tenido la empresa llamado Davis y que la catapultó en España gracias al revolucionario sistema de muelles y armazón de hierro que incorporaba, desarrollado por José Gras y patentado por Grassoler, llamado Intelligent System®, considerado un diseño que incorporaba gran ingeniería constructiva. Ha sido la culminación del binomio diseño y ergonomía que consigue el máximo descanso. Todo ello hace de un Grassoler una pieza muy especial y única.

Tradition allied with technics

Tradición aliada a la técnica

EN · From the beginning, 58 years ago, our philosophy has always been the search for technological innovation and advances, beautifully blended with the traditional processes of handcrafted furniture.

ES · Durante 58 años nuestra filosofía siempre ha sido la permanente búsqueda de avances técnicos en los materiales y en los procesos de fabricación, fusionándolos con los métodos tradicionales y artesanos de fabricación.

What we do best

Qué hacemos

EN · We manufacture innovative contemporary furniture developed with the highest quality standards. Our collection is polyvalent in that it can be applied in hospitalty lounge areas, corporate environments as well as residential use. We can provide an extensive list of references / installations in Hotels, Restaurants, Sports Clubs, Airport Lounges, Financial, Corporate Offices, Healthcare, Educational, Institutional, Luxury Residential and Customized Environments from around the world.

ES · Fabricamos mobiliario contemporáneo desarrollado con los estándares de la más alta calidad. Nuestra colección es polivalente y se ajusta a todo tipo de espacios públicos y corporativos, además del residencial. Tenemos una amplia lista de referencias de proyectos en hoteles, restaurantes, clubs deportivos, salas business de aeropuertos, sector financiero, oficinas corporativas, sector salud, educativo, institucional, además del residencial de lujo y en el entorno “hecho a medida”.

Around the world

Alrededor del mundo

EN · We have wide experience in providing furniture worldwide since 38 years, exporting over the 5 continents.

ES · Tenemos amplia experiencia de más de 38 años en proveer mobiliario por todo el mundo, exportando alrededor de los 5 continentes.

We are ready to create your layouts

Estamos listos para diseñar tus layouts

EN · We can help to plan the space with our models, giving you different solutions in order to create a unique project and thus make it easier to take decisions. We will propose different layouts and sketches for the same area. Thanks to our vast experience, we can recommend the kind of sofa and the fabrics that are more suitable.

ES · Podemos ayudarte a diseñar tu espacio con nuestros muebles, te plantearemos soluciones diferentes para crear un proyecto singular y único y facilitarte así la toma de decisiones. Propondremos varios layouts y distribuciones dentro de la misma área. Gracias a nuestra extensa experiencia podemos recomendarte qué tipo de sofás y telas son los más adecuados para tu proyecto.



Index

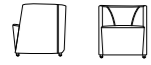

Berlin 134 · **137**



Berna 138 · **141**



Boy 12 · **17**

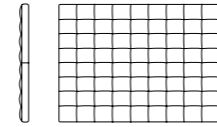

Cabecero 92 · **93**

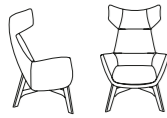

Charme 82 · **87**

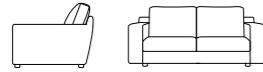

Dakota · Definy 124 · **129**



Daris 130 · **133**



Deep 87 18 · **21**



Fortune 168 · **171**

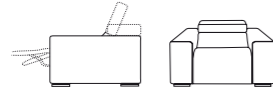

Goby 172 · **173**



Hero '06 144 · **145**

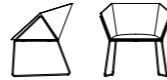

Hexa 22 · **27**

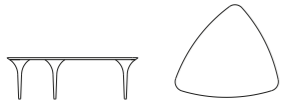

Hiru · Hirusta 94 · **95**



Kanel 88 · **91**



Kanel fluffy 28 · **31**



Koly 146 · **147**



Lavanda · Menta · Salvia 100 · **101**

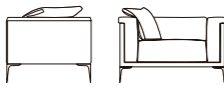

Mad 32 · **39**



Madalena 122 · **123**

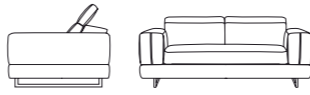

Mildred 40 · **43**



Nicolay 44 · **51**



Odyssey 102 · **109**



Onix 110 · **113**

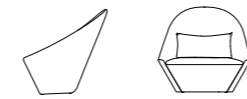

Opal 116 · **117**

Index



Opalina 118 · **121**



Oracle 114 · **115**



Parade 160 · **161**



Parcel 162 · **163**

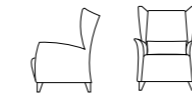

Parody 158 · **159**



Perla 164 · **165**



Place 166 · **167**



Rhapsody 174 · **177**

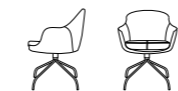

Riverso 154 · **157**



Romulus 178 · **179**



Rosetta 148 · **153**

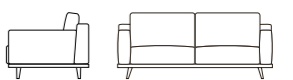

Sapore 52 · **57**



Sunday 142 · **143**



Thunder MMS 70 · **73**



Traffic MMS 68 · **69**

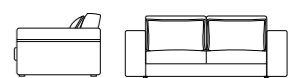

Transit MMS 62 · **67**



Triumph MMS 74 · **77**

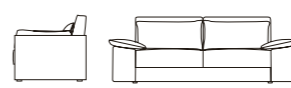

Tulsa MMS 58 · **61**

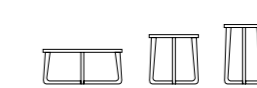

Wasabi 96 · **99**

Products





Cabezal K- Head cushion K

Cabezal E - Head cushion E



Pies metálicos cromo negro - metallic feet black finish

Pies madera natural - Beechwood varnished in natural

Boy

By José Gras

EN · Solid wood covered by polyether. Interlaced elastic webbing. Seat in 30 Kg/m3 high resilience polyether (CFC free). Back in a combination of 60% antiallergic hollow fibre and 40% down feather. Arm in 100% microfiber cushions. Feet in beechwood varnished in natural and walnut, or metallic feet chromed black finish. Fixed upholstery and completely removable cover in the cushions.

ES · Madera maciza recubierta de poliéter y guata acrílica. Cinchas elasticas entrelazadas. Asiento de poliéter de 30 kg/m3 (sin cfc.) recubierto de guata acrílica. Respaldo de combinación de 60% de fibra antialérgica y 40% de pluma de ave acuática. Sobrebrazos cojines 100% fibra antialérgica. Pies de madera de haya barnizada en colores natural y nogal, o pie metálico acabado cromo negro. Estructura tapizado fijo, cojines desenfundables.

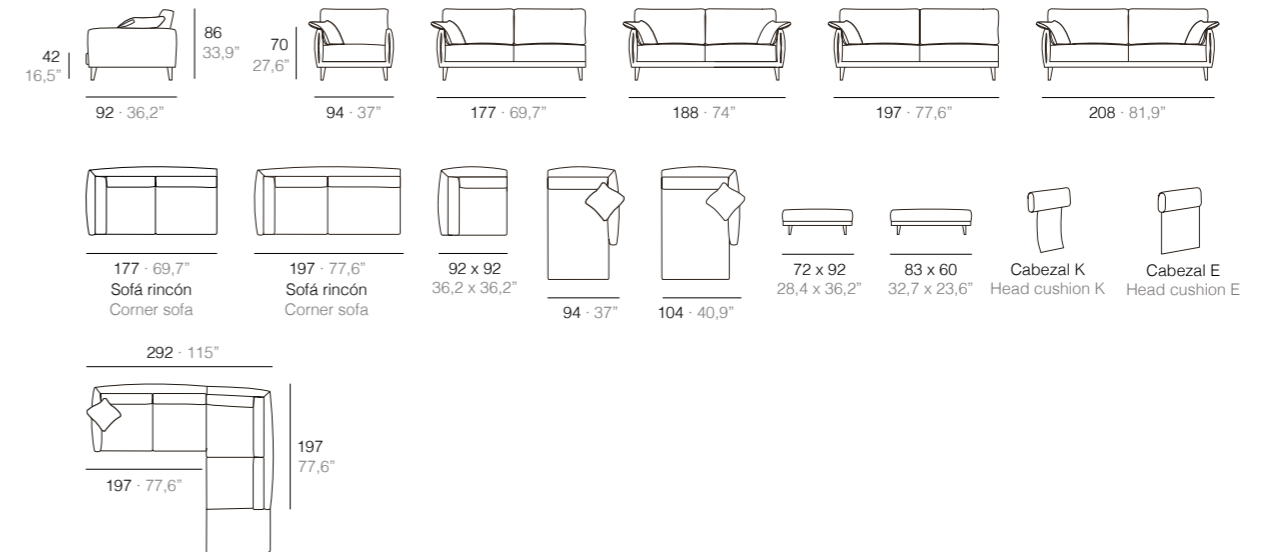





Deep 87

By Yoshiaru Hatano

EN · Solid wood covered by polyether. Interlaced elastic webbing. Seat in 35 Kg/m³ high resilience polyether (CFC free). Back in a combination of 60% antiallergic hollow fibre and 40% down feather. Metallic feet painted in brown. Fixed upholstery and completely removable cover in the cushions.

ES · Madera maciza recubierta de poliéter. Cinchas elásticas entrelazadas. Asiento cojín de poliéter de 35 Kg/m³ (sin cfc). Respaldo de combinación de 60% de fibra antialérgica y 40% de pluma de ave acuática. Pies metálicos pintados en marrón. Estructura tapizado fijo, cojines desfundables.

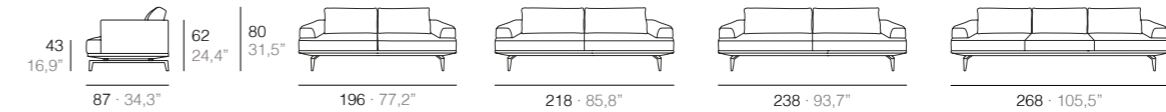







Hexa

By The RoBoT DESIGN

EN · Beech plywood covered by polyether.

Seat and back in 40 Kg/m³. polyether (CFC free). Feet in 12mm solid metal rod with plastic sliders. Painted, colour to be chosen by the customer. Fixed upholstery.

ES · Contrachapado de haya recubierto de poliéter. Asiento y respaldo de poliéter 40 Kg/m³. (sin CFC). Pies de varilla de metal macizo de 12 mm con deslizadores de plástico. Pintado, color a elegir por el cliente. Tapizado fijo.

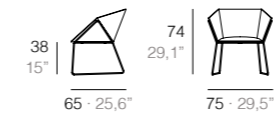



Kanel fluffy

By Grassoler Studio

EN · Solid wood covered by polyether. Interlaced elastic webbing. Seat in 35 Kg/m3 high resilience polyether (CFC free). Back in 30 Kg/m3 polyether (CFC free). Back side covered with padding and pipping. Chromed metallic feet or painted in any Pantone color. Fixed upholstery.

ES · Madera maciza recubierta de poliéter. Cinchas elásticas entrelazadas. Asiento cojín de poliéter de 35 Kg/m3 (sin cfc). Respaldo cojín de poliéter de 30 Kg/m3 (sin cfc). Exterior respaldo acolchado y con vivos. Pies barilla cromada. Opción pintada en color RAL. Tapizado fijo.





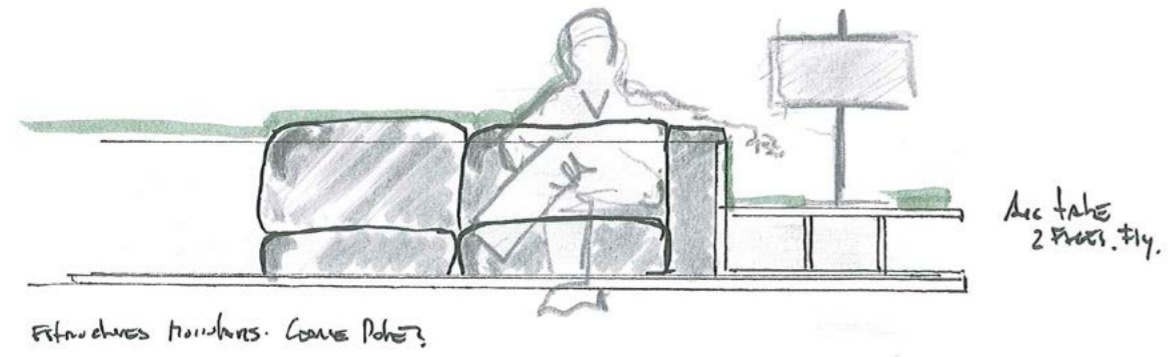

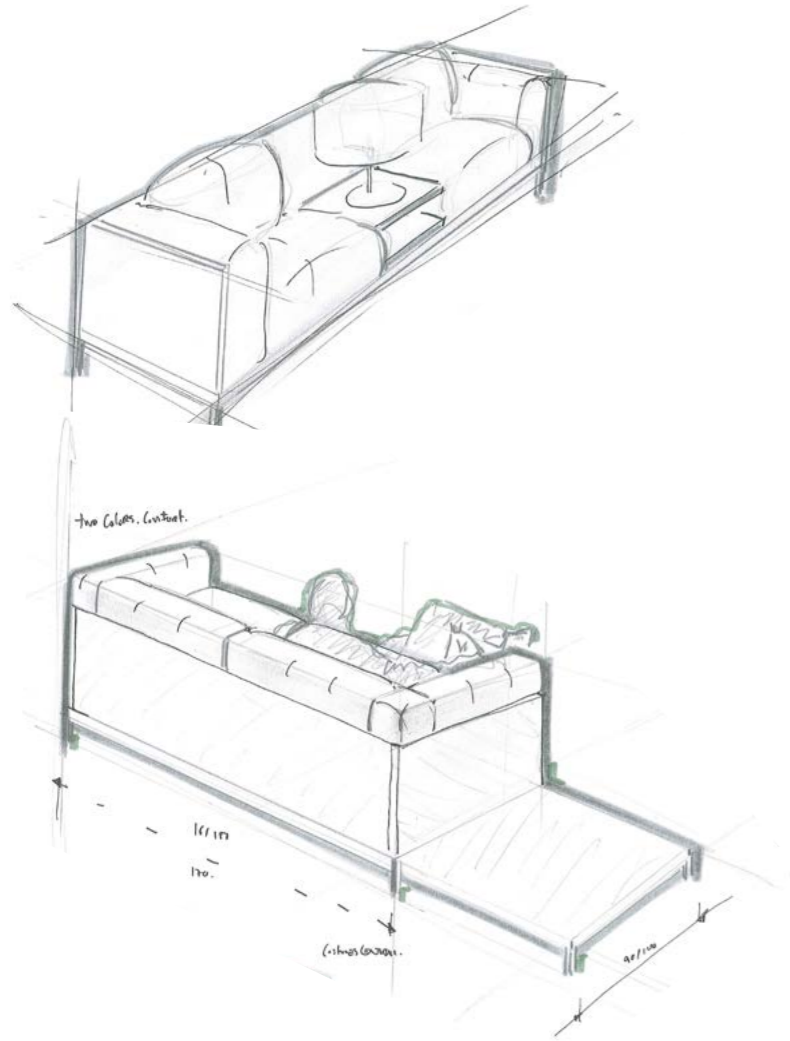

MAD HOME



MAD BUREAU





Mad

By The RoBoT DESIGN

EN · Frame in 40 mm MDF, in natural walnut veneer. Seat in thermic viscoelastic cushion with 50 Kg. "memory effect" foam + a 30 Kg/m³. soft polyether cushion (cfc free).

MAD Home: Back cushions in a combination of 60% antiallergic hollow fibre and 40% down feather. Arm cushions in 30 Kg/m³ polyether cushion (cfc. free), covered by acrylic padding

MAD Bureau: Back cushions in 25 Kg/m³ polyether (cfc free).

Arm cushions in 30 Kg/m³. + 60 Kg/m³ polyether (cfc free), covered by acrylic padding. Metallic feet chromed black finish.

Fixed upholstery and completely removable cover in the cushions.

ES · Estructura en MDF de 40 mm. en chapa natural de nogal americano. Asiento cojín visco térmico de poliéter 50 Kg/m³ extraconfort "efecto retorno"+ poliéter de 30 Kg/m³ suave (sin cfc).

MAD Home: Respaldo combinación de 60% de fibra antialérgica y 40% de pluma de ave acuática. Brazos ojín de poliéter de 30 Kg/m³ (sin cfc) recubierto de boata acrílica.

MAD Bureau: Respaldo cojín poliéter de 25 Kg/m³ con refuerzo de 60 Kg/m³. Brazos cojín de poliéter de 30 Kg/m³ (sin cfc) con refuerzo de 60 Kg/m³ y recubierto de boata acrílica. Pies con acabado cromo negro. Tapizado fijo y cojines desenfundables.

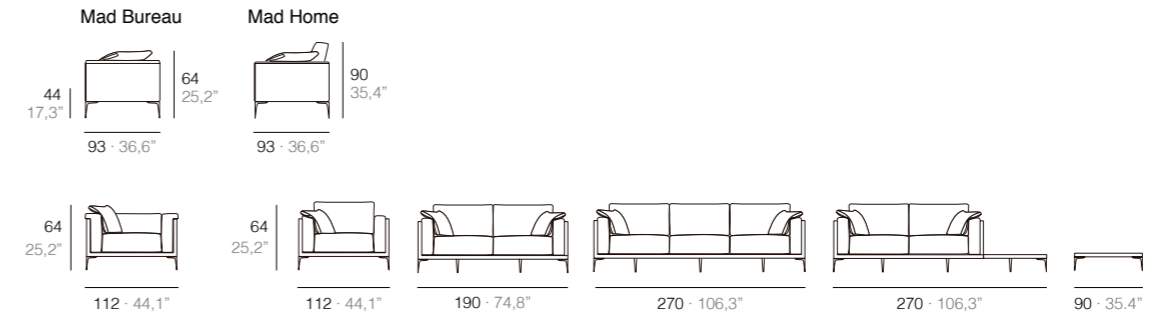

MAD HOME



MAD BUREAU



Mildred

By José Gras

EN · Metallic anticorrosion painted frame, covered by polyether. Interlaced elastic webbing suspension. Seat in 35 Kg/m3 polyether (cfc free). + viscoelastic cushions 55 Kg/m3 “memory effect” foam. Back and headcushion in 23 Kg/m3. polyether cushion (cfc free), covered by acrylic padding. Adjustable headcushion. Metallic feet black painted. Fixed upholstery and completely removable cover in the seat cushion.

ES · Estructura metálica pintada anticorrosión recubierta de poliéter. Suspensión mediante cinchas entrelazadas. Asiento de poliéter de 35 Kg/m3 (sin cfc) + visco extraconfort “efecto retorno”. Recubierto de guata acrílica. Respaldo y cabezal de poliéter de 23 Kg/m3 (sin cfc.), recubierto de guata acrílica. Pies metálicos pintados color negro. Mecanismo cabezal multiposicional manual. Estructura tapizado fijo y cojín de asiento desenfundable.

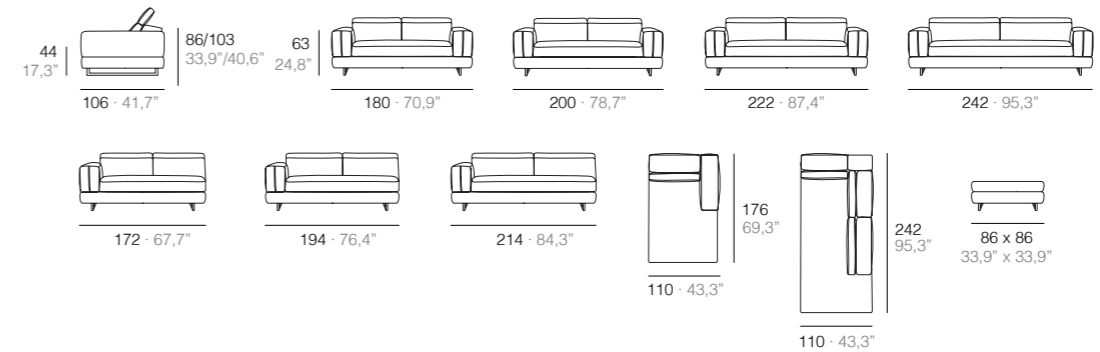









Nicolay

By Grassoler Studio

EN · Solid wood frame, interlaced elastic webbing suspension. Seat in 100% microfiber with 30 Kg/m³ polyether. Back in 100% microfiber. Wooden feet varnished in wengue. Completely removable covers.

ES · Madera maciza recubierta de poliéster. Cinchas elásticas entrelazadas. Asiento 100% microfibra con inserto de poliéter 30 Kg/m³. Respaldos 100% microfibra. Pies en madera barnizado wengué. Totalmente desenfundable.

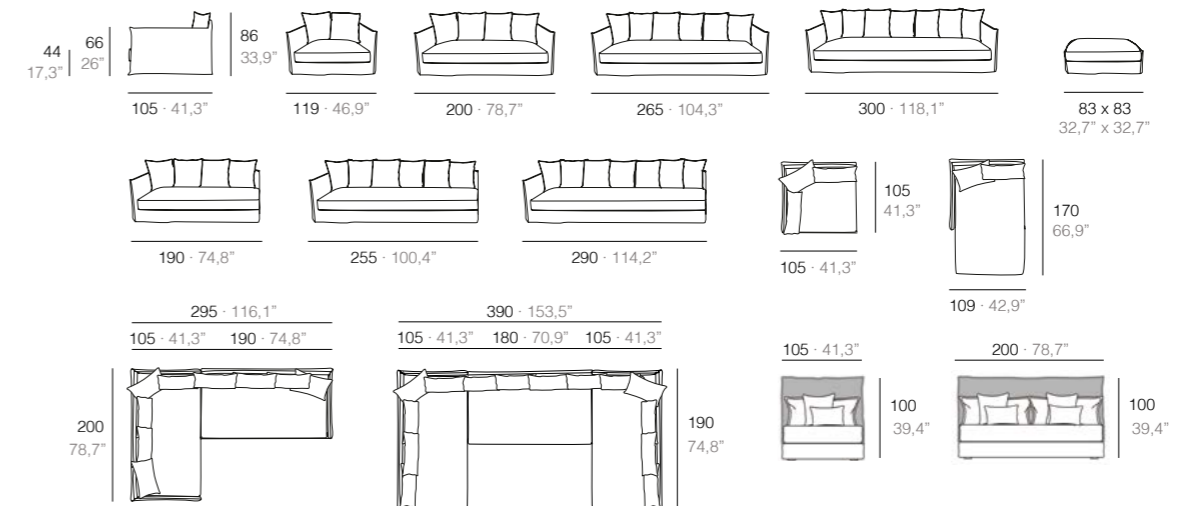





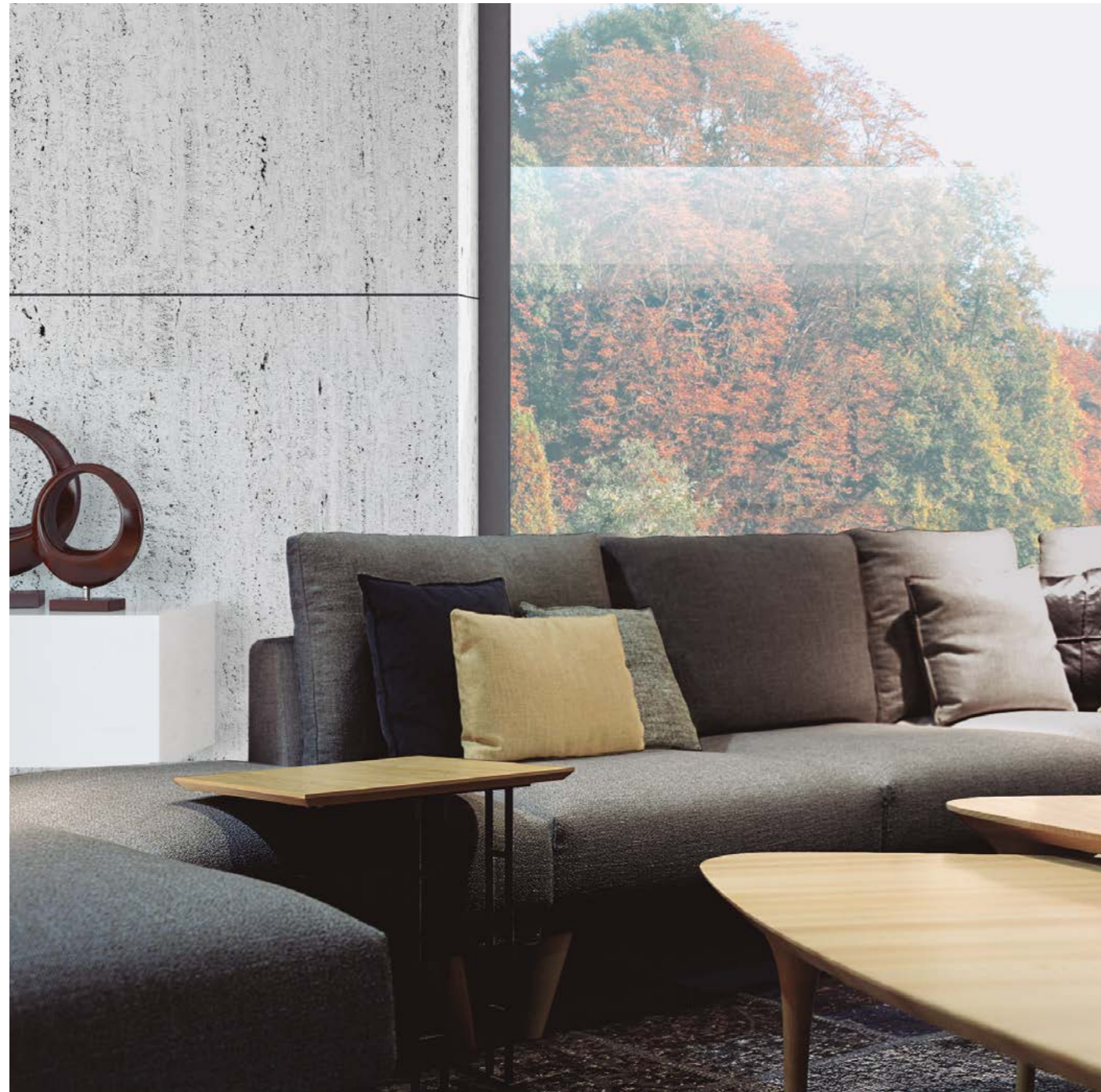

Sapore

By José Gras

EN · Metallic anticorrosion painted frame, covered by polyether. Arms in solid wood frame covered by polyether. Suspension by means of elastic webbings. Seat in a thermic viscoelastic cushion with 50 Kg/m3 “memory effect” foam + a 30 Kg/m3 soft polyether cushion (cfc free). Back in a combination of 60% antiallergic hollow fibre and 40% down feather. Feet in beechwood varnished in natural or walnut. Fixed upholstery and completely removable covers in the cushions.

ES · Estructura metálica pintada anticorrosión recubierta de poliéter. Brazos de madera maciza recubierta de poliéter. Suspensión mediante cinchas elásticas entrelazadas. Asiento cojín visco térmico, poliéter 50 Kg/m3 extraconfort “efecto retorno” + poliéter de 30 Kg/m3 suave (sin cfc). Respaldo de combinación de 60% de fibra antialérgica y 40% de pluma de ave acuática. Pies de madera de haya barnizada en colores natural o nogal. Estructura tapizado fijo y cojines desenfundables.

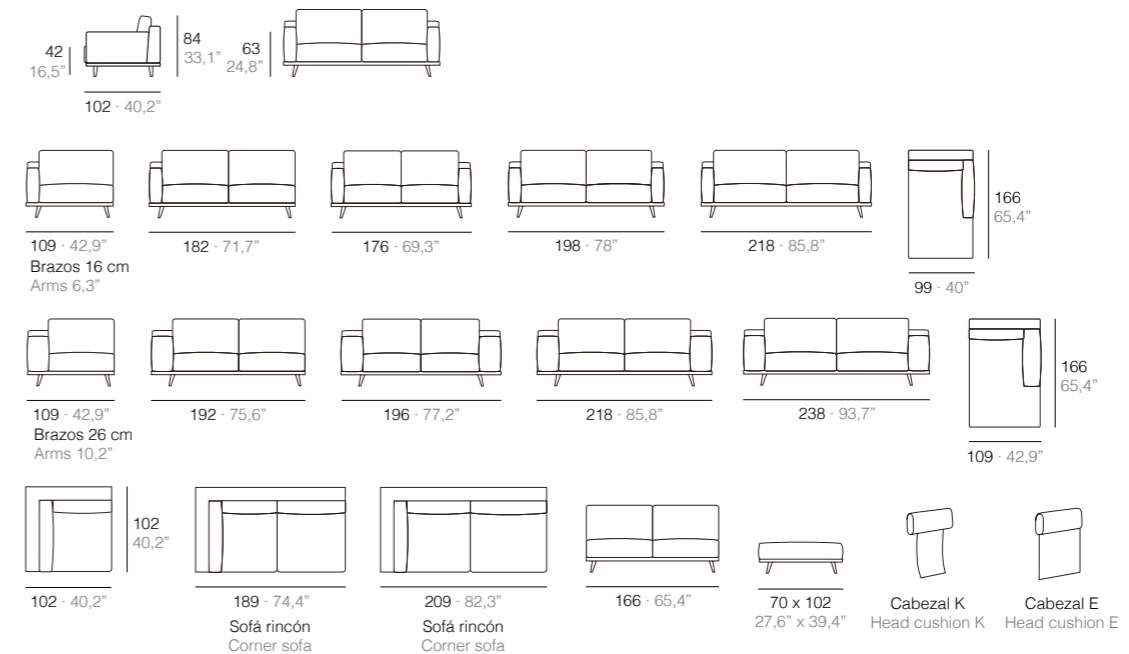

Brazos 26 cm
Arms 10,2"



Brazos 16 cm
Arms 6,3"





Tulsa

By José Gras

EN · Metallic frame, knock down structure. Suspension by metallic springs, comfort to choose: soft, middle or firm. Two seat inclination. Seat in thermic viscoelastic 50 Kg/m³ “memory effect” foam + 30 Kg/m³ polyether. Back in 25 Kg/m³ polyether. Kidney cushions in a combination fibre/feather. Completely removable covers.

ES · Estructura metálica totalmente desmontable. Suspensión mediante muelles, confort a elegir: suave, medio, firme. Dos inclinaciones de asiento. Asiento cojín visco térmico poliéter 50 Kg/m³ extraconfort “efecto retorno”+ poliéter de 30 Kg/m³. Respaldo de poliéter de 25 Kg/m³. Riñonera en fibra/pluma. Totalmente desenfundable.

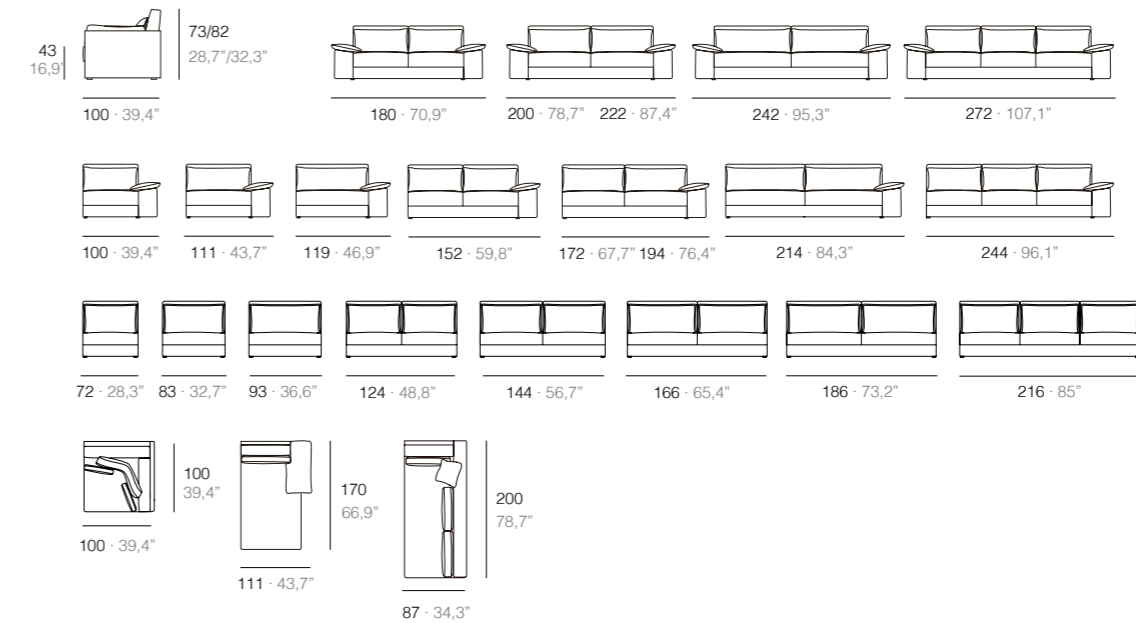







Transit MMS

By José Gras

EN · Metallic frame, knock down structure, suspension by metallic springs comfort to choose: soft, middle or firm. Two seat inclinations. Seat in viscoelastic cushions with 55 Kg/m³ “memory effect” foam, back in 25 Kg/m³ polyether, kidney cushions in down feather/fiber. Completely removable covers.

ES · Estructura metálica totalmente desmontable. Suspensión mediante muelles, confort a elegir: suave, medio y firme. Dos inclinaciones de asiento. Asiento viscoelástico 55 Kg/m³ poliéter extraconfort “efecto retorno”, respaldo de poliéter 25 Kg/m³ riñoneras en pluma/fibra. Totalmente desenfundable.

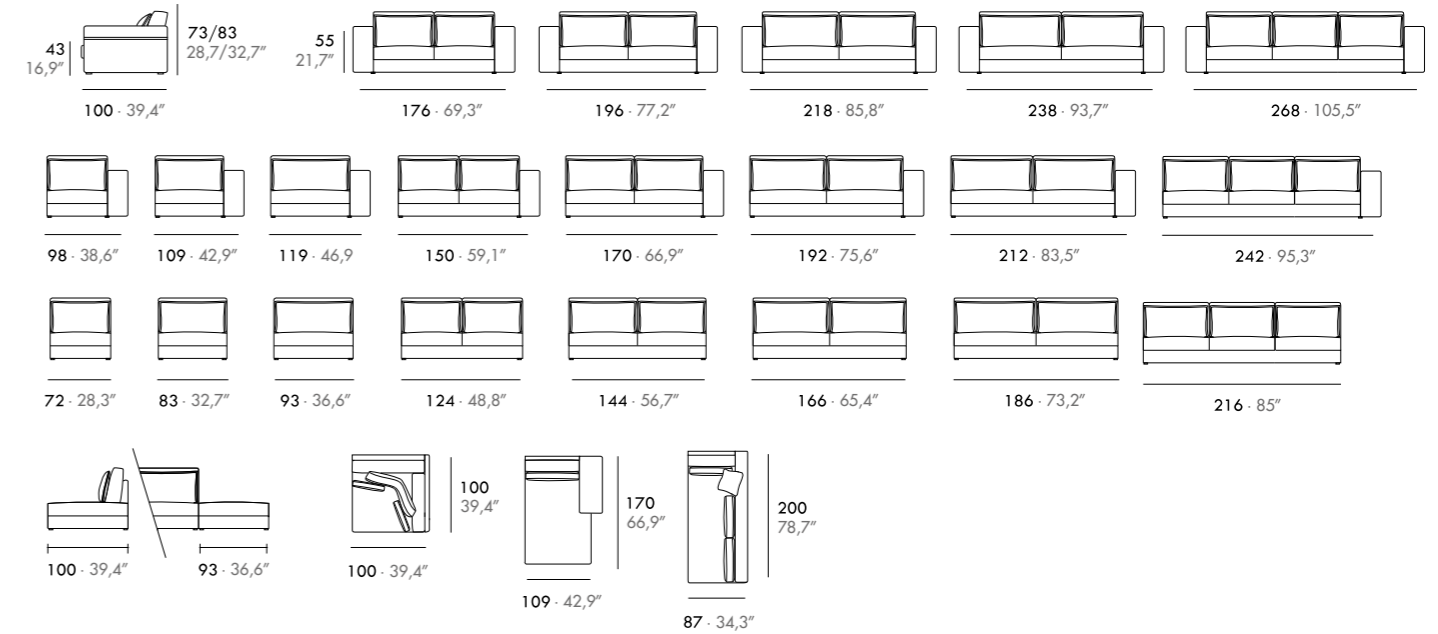



Traffic MMS

By José Gras

EN · Metallic frame, knock down structure, suspension by metallic springs comfort to choose: soft, middle or firm. Two seat inclinations. Seat in viscoelastic cushions with 55 Kg/m³ “memory effect” foam, back in 25 Kg/m³ polyether, kidney cushions in down feather/fiber. Completely removable covers.

ES · Estructura metálica totalmente desmontable. Suspensión mediante muelles, confort a elegir: suave, medio y firme. Dos inclinaciones de asiento. Asiento viscoelástico 55 Kg/m³ poliéter extraconfort “efecto retorno”, respaldo de poliéter 25 Kg/m³ riñoneras en pluma/fibra. Totalmente desenfundable.

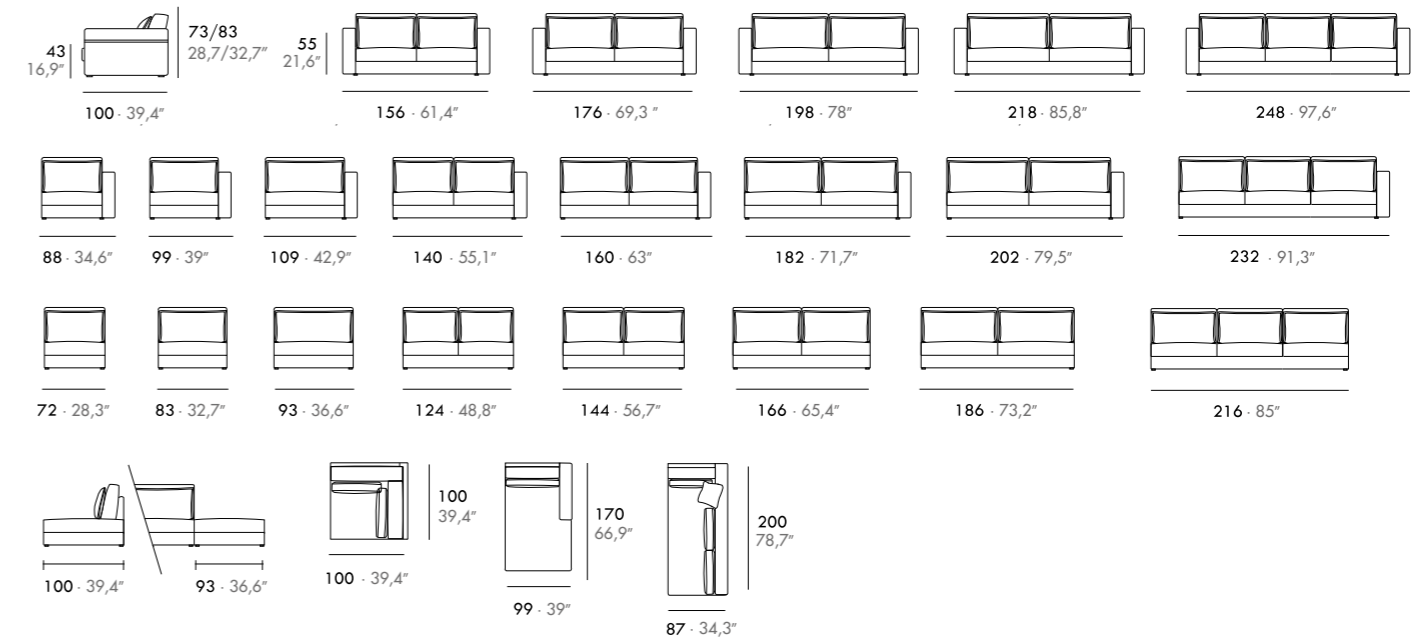





Thunder MMS

By José Gras

EN · Metallic frame, knock down structure. Suspension by metallic springs, comfort to choose: soft, middle or firm. Two seat inclinations. Seat in down feather with interior in "Viscoelastic" extracomfort 55 Kg/m³ "memory effect" foam. Back 25 Kg/m³ polyether, kidney cushions in a combination of polyether/fiber/down feather.

Option: seat in "Viscoelastic". Completely removable covers.

ES · Estructura metálica totalmente desmontable. Suspensión mediante muelles, confort a elegir: suave, medio y firme. Dos inclinaciones de asiento. Asiento en pluma con interior en viscoelástico 55Kg/m³ poliéter "efecto retorno". Respaldo poliéter 25 Kg/m³, riñonera combinación de poliéter/fibra/pluma. Opción: asiento en viscoelástico. Totalmente desenfundable.

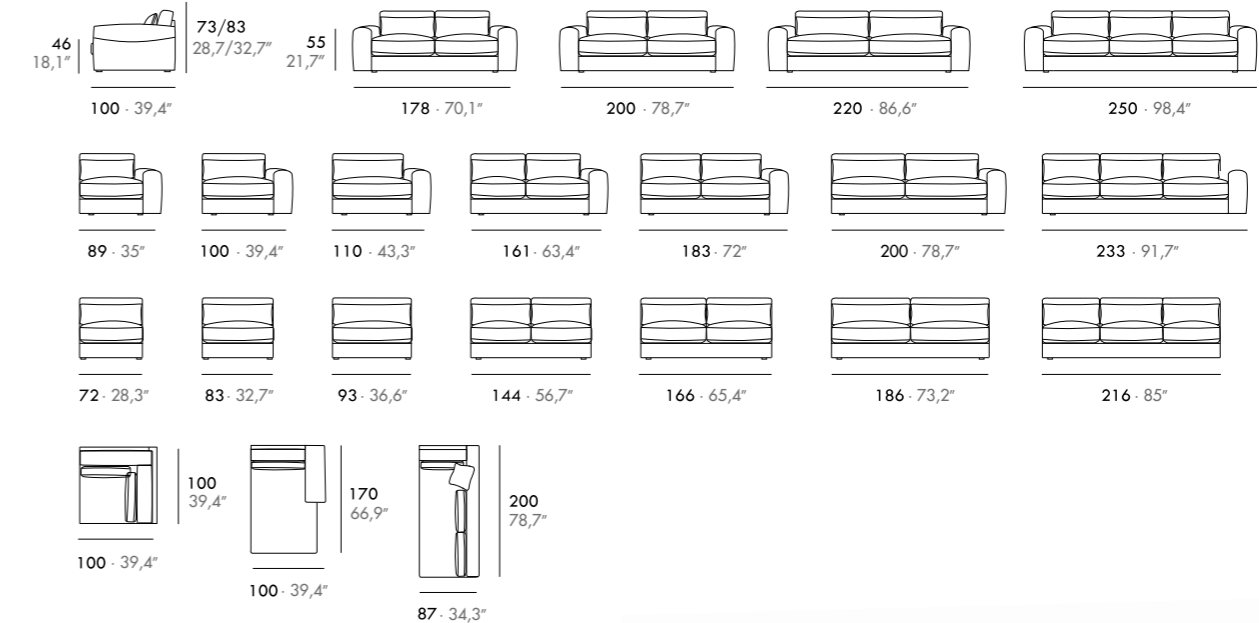





Triumph MMS

By José Gras

EN · Metallic frame, knock down structure. Suspension by metallic springs comfort to choose: soft, middle or firm. Two seat inclinations. Seat in down feather with interior in Viscoelastic 55 Kg/m³ “memory effect” foam. Back cushions in a combination of polyether/fiber/down feather. Completely removable covers. Option: Seat in Viscoelastic 55 Kg/m³ “memory effect” polyether. Back cushion in 25 Kg/m³ polyether.

ES · Estructura metálica totalmente desmontable. Suspensión mediante muelles confort a elegir: suave, medio y firme. Dos inclinaciones de asiento. Asiento en pluma con interior en viscoelástico 55 Kg/m³ poliéter extraconfort “efecto retorno”, respaldo en combinación de poliéter/fibra/pluma. Totalmente desenfundable. Opción: Asiento en viscoelástico 55 Kg/m³ extraconfort “efecto retorno”. Respaldo en poliéter 25 Kg/m³.

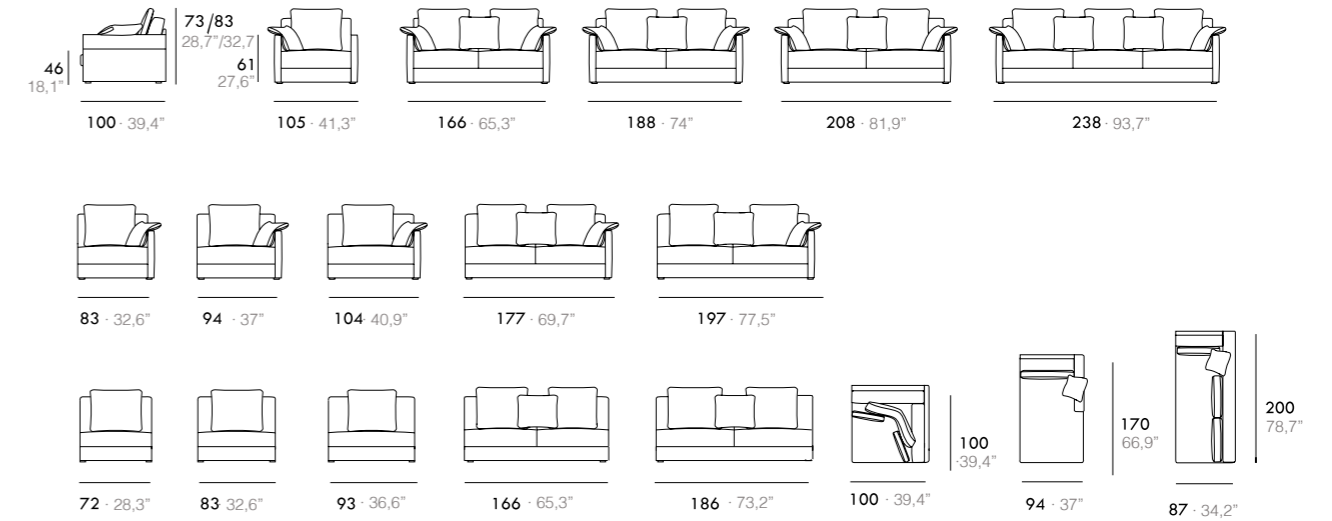

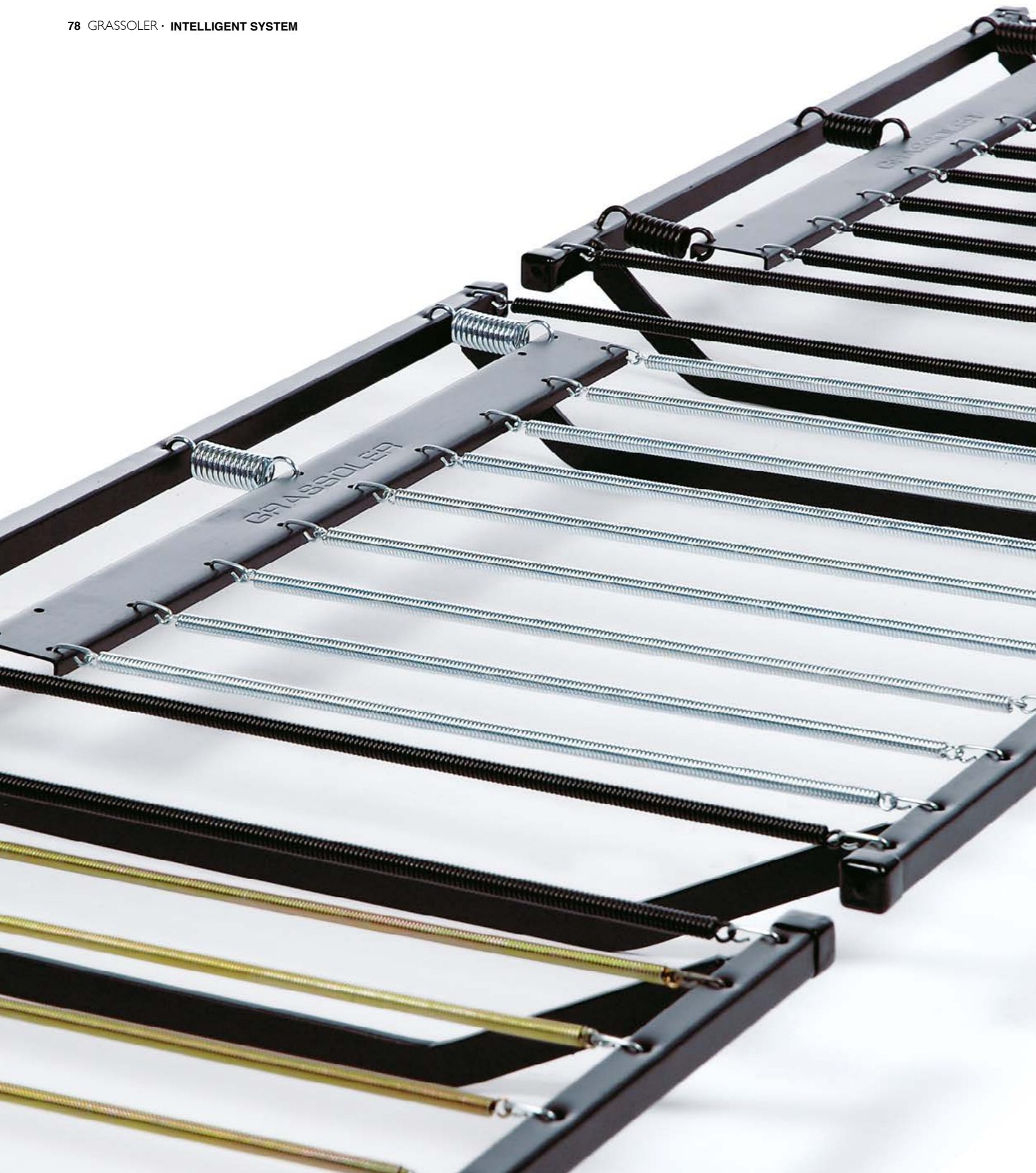

Steel frame structure

EN · Since the mid 1960's, Grassoler has been manufacturing the inside structure of our sofas with steel metal frames, which were developed and patented under the trade name Intelligent System. The laminated steel provides our sofa frame structures with very high level of strenght and unsurpassed durability. It makes them unique pieces, almost indestructible so that they can be enjoyed for many more years than traditional wooden frames.

25 year warranty

EN · Our sofas have level 5 (maximum level) UNE 11020 part 2 and UNE EN 1022-98 corresponding to severe public use. This is equivalent to a test of more than 200.00 drop cycles of 95 kg (210 lbs.) weight. As a result of the excellent material quality, we offer a 25 year warranty of the steel structure, absolutely exceptional in this market sector.

“Tailor made suspension”

EN · The Intelligent System suspension is a system developed and patented by Grassoler more than 50 years ago. It provides you with a “customized suspension system” meaning that you can personalize the level of firmness in the seat to your own desire. There are three different firmness options: soft, middle and firm.

Estructuras metálicas

ES · En Grassoler llevamos fabricando los interiores de los sofás en acero desde 1963, año en el que desarrollamos y patentamos nuestro exclusivo sistema Intelligent System. El acero por sí mismo, además de dar gran solidez y durabilidad a los sofás, los convierten en piezas únicas. Únicas, indeformables y resistentes al paso de los años.

25 años de garantía

ES · Nuestros productos superan el nivel 5 (nivel máximo) de la norma UNE 11020 parte 2 y UNE EN 1022-98 correspondiente a uso público severo. Entre otras pruebas, equivale a más de 200.000 sentadas con un peso de 95 kg. Como resultado de esta excelente calidad, ofrecemos una garantía de 25 años de fabricación en las estructuras metálicas, algo absolutamente único.

“Suspensión a la carta”

ES · La suspensión Intelligent System es un sistema desarrollado y patentado por Grassoler hace más de 50 años. Se trata de la “suspensión a la carta” que permite personalizar y adaptar la sentada eligiendo el confort individual en cada sofá, consiguiendo una mayor comodidad. Existen tres opciones posibles: suave, media o firme.



Ease of Disassembly

EN · You can easily assemble or disassemble the sofa seats, arms and legs without tools. By simply unscrewing the knobs with your hands and reach through the zippers in the back frame, you will find the knobs that hold the structure together.

Totalmente desmontable

ES · A través de unas cremalleras y palomillas en la estructura, permiten montar y desmontar los módulos, los brazos y pies sin necesidad de herramientas en sencillos pasos.

Removable upholstery covers

EN · Our sofa covers are easily removable with a system of zippers and velcro that split the covers of the sofa into several parts. The covers can then be washed in a washing machine or taken to the dry cleaner in case the upholstery material requires it.

Totalmente desenfundable

ES · Nuestros sofás son fácilmente desenfundables mediante cremalleras y velcros que dividen las fundas del sofá en varias partes para lavar cómodamente en la lavadora doméstica o llevar a la tintorería en el caso que así lo requiera la tapicería elegida.

Replaceable upholstery parts

EN · This system allows you to individually replace part of the sofa that could have been damaged after use, for example: you can replace the arm or just the cover of the arm, depending if the damage is on the fabric or in the structure of the arm.

Recambios de piezas

ES · Este sistema permite reemplazar individualmente partes que con el uso hayan podido ser dañadas, por ejemplo: se puede reponer el brazo o sólo la funda del brazo dependiendo si el daño está en la tela o en la estructura del brazo.







Charme

By Grassoler Studio

EN · Cold moulded foam module over metallic frame. Swivel only with metallic base option. Fix upholstery.

ES · Espuma de poliuretano moldeado en frío sobre estructura de acero. Base giratoria sólo con la opción metálica. Tapizado fijo.

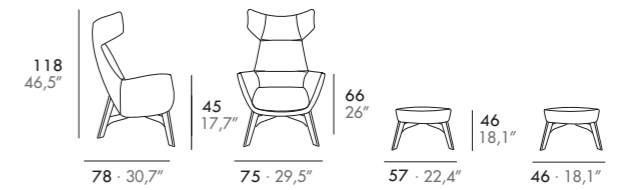
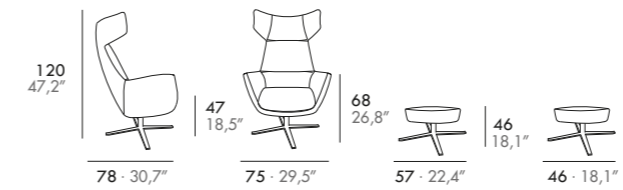





Kanel

By Gabriel Teixidó

EN · Solid wood covered by polyether. Interlaced elastic webbing. Seat in 35 Kg/m³ high resilience polyether (CFC free). Back in 30 Kg/m³ polyether (CFC free). Chromed metallic feet or painted in any Pantone color. Fixed upholstery.

ES · Madera maciza recubierta de poliéter. Cinchas elásticas entrelazadas. Asiento cojín de poliéter de 35 Kg/m³ (sin cfc). Respaldo cojín de poliéter de 30 Kg/m³ (sin cfc). Pies barilla cromada. Opción pintada en color RAL. Tapizado fijo.

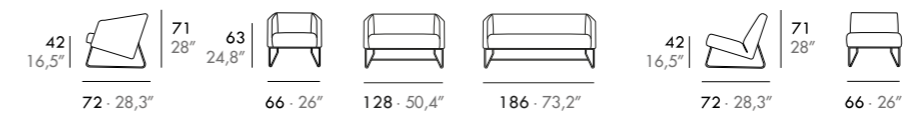



Cabecero

By Grassoler Studio

EN · Solid wood frame, 25 Kg/m3 polyether. Fix upholstery.

ES · Estructura madera maciza, poliéter 25 Kg/m3 Tapizado fijo.

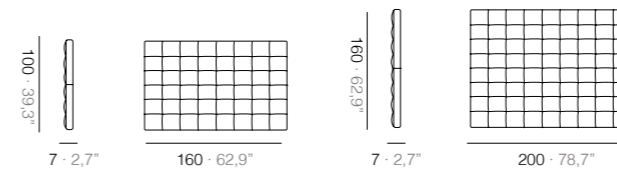



Hiru · Hirusta

By Gabriel Teixidó

EN · Coffee table in solid beechwood varnished in oak, walnut or wengué or lacquered in white or black.

ES · Mesa de centro en madera maciza de haya barnizada en color roble, nogal, wengué o lacada en blanco o en negro.

Hiru

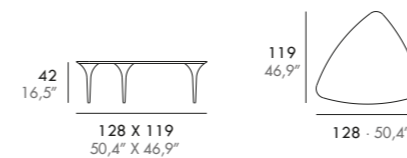

Hirusta

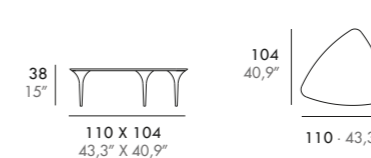





Wasabi

By Grassoler Studio

EN · Coffee table in solid wood frame varnished in oak or natural, or lacquered in white or black.

ES · Mesa de centro en madera maciza barnizada en color roble, o natural, o lacada en blanco o en negro.

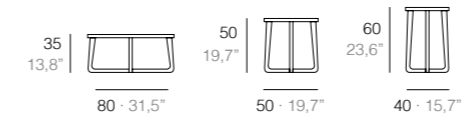



Lavanda · Menta · Salvia

By José Gras

EN · Side table in natural veneer walnut, oak and wenge or white lacquered. Steel base, painted in white or black.

ES · Mesa auxiliar en chapa natural de nogal, roble y wengué, o acabado lacado en blanco. Base metálica de acero laminado, pintada blanca o negra.

Lavanda

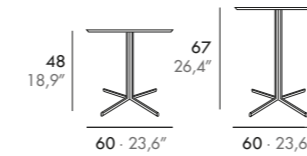

Menta

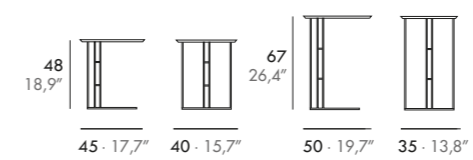

Salvia

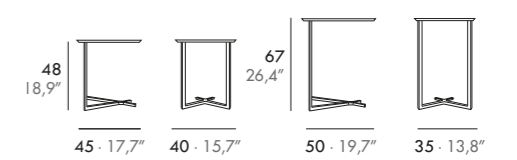

Lavanda



Menta



Salvia









Odyssey

By José Gras

EN · Metallic frame. Suspension by Nea elastic webbings. Seat in 35 Kg/m³ and 23 Kg/m³ polyether. Back with a combination of fiber/down feather, cushions in antiallergic fibre. Fixed upholstery. Option: completely removable covers.

ES · Estructura metálica. Suspensión mediante cinchas Nea. Asiento en poliéter de 35Kg/m³ y 23 Kg/m³. Respaldo en combinación de fibra y pluma, cojines sobrecodos en microfibra antialérgica. Tapizado fijo y opción totalmente desenfundable.

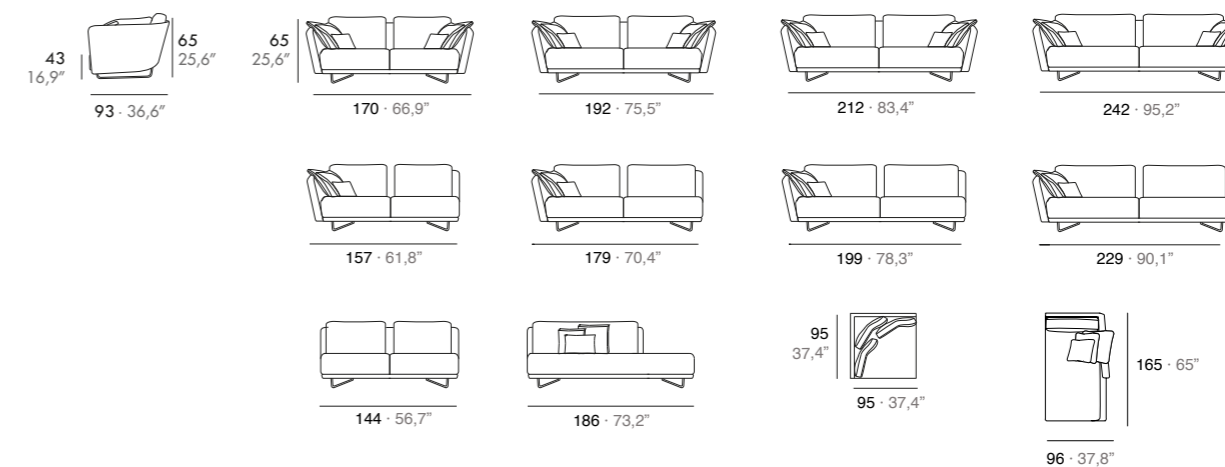





Onix

By Gabriel Teixidó

EN · Metallic frame. Suspension by Nosag springs, seat in 35 Kg/m³ polyether. Back and kidney cushion with a combination of fiber/down feathers. Completely removable covers.

ES · Estructura metálica. Suspensión mediante muelles Nosag. Asiento en poliéter de 35 Kg/m³. Respaldo y riñoneras en combinación de fibra y pluma. Totalmente desenfundable.

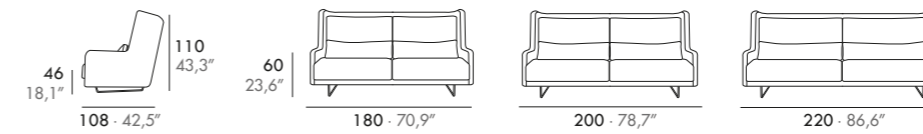



Oracle

By Gabriel Teixidó

EN · Metallic frame. Suspension by NEA elastic webbings. Seat in "Viscoelastic" extracomfort 55 Kg /m³ "memory effect" polyether. Back, arm and kidney cushions in down feathers. Completely removable covers.

ES · Estructura metálica. Suspensión mediante cinchas NEA. Asiento viscoelástico 55Kg/m³ extraconfort "efecto retorno". Respaldo, brazo y riñoneras de pluma. Totalmente desenfundable.

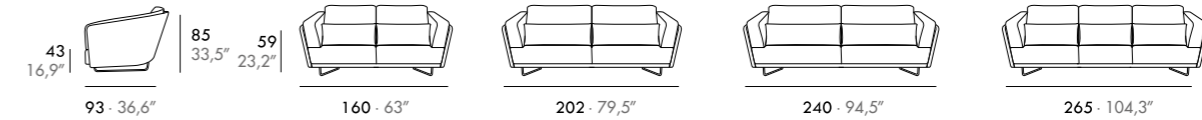



Opal

By Gabriel Teixidó

EN · Solid wood frame. 35 Kg/m³ polyether seat and 25 Kg/m³ polyether back, kidney cushion in fiber. Fix upholstery.

ES · Estructura madera maciza. Asiento poliéter 35 Kg/m³. Respaldo poliéter 25 Kg/m³. Riñonera en fibra. Tapizado fijo.

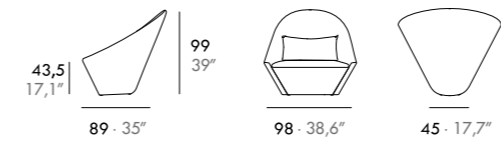





Opalina

By Gabriel Teixidó

EN · Solid wood frame. 35 Kg/m3 polyether seat and 25 Kg/m3 polyether back. Fix upholstery.

ES · Estructura madera maciza, asiento poliéter 35 Kg/m3. Respaldo poliéter 25 Kg/m3. Tapizado fijo.

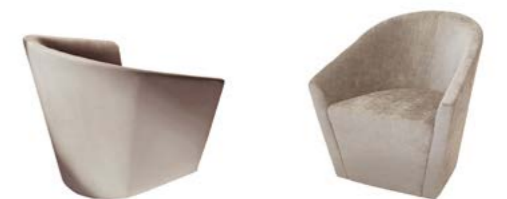



Madalena

By Gabriel Teixidó

EN · Solid wood frame. 35 Kg/m3 polyether seat.

ES · Estructura madera maciza. Asiento poliéter 35 Kg/m3.









Dakota



Definy

Dakota · Definy

By José Gras

EN · Metallic frame, knock down arms. Suspension by metallic springs, comfort to choose: soft, middle or firm. Two seat inclinations. Seat in "Viscoelastic" 55 Kg/m³ "memory effect" foam, fiber back cushions. Completely removable covers.

ES · Estructura metálica, brazos desmontables. Suspensión mediante muelles, confort a elegir: suave, medio y firme. Dos inclinaciones de asiento. Asiento viscoelástico 55Kg/m³ poliéter extraconfort "efecto retorno". Respaldo de fibra. Totalmente desenfundable.

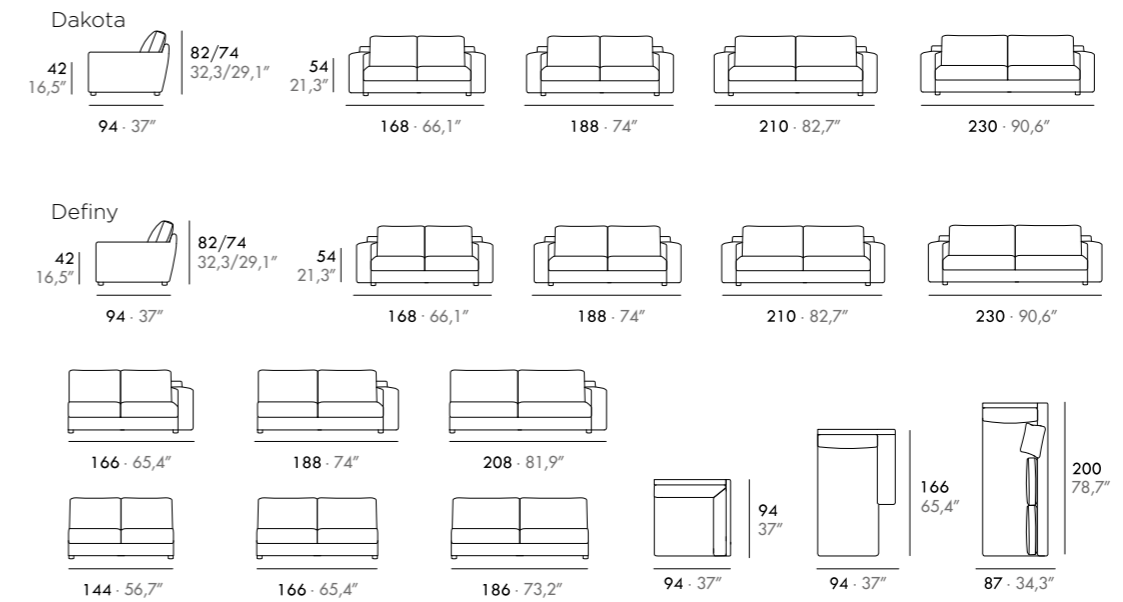

Dakota

Definy





Daris

By José Gras

EN · Metallic frame, knock down arms. Suspension by metallic springs, comfort to choose: soft, middle or firm. Two seat inclinations, 35 Kg/m³. polyether seat. Fiber back cushions. Completely removable covers.

ES · Estructura metálica, brazos desmontables. Suspensión mediante muelles, confort a elegir: suave, medio y firme. Dos inclinaciones de asiento. Asiento poliéter 35 Kg/m³. Respaldo en fibra. Totalmente desenfundable.

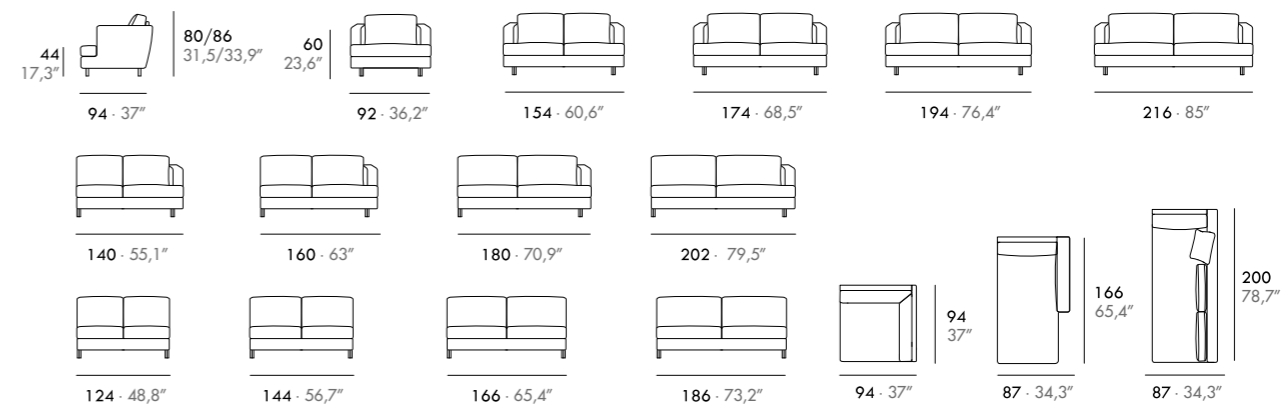





Berlin

By José Gras

EN · Solid wood frame. 35 Kg/m³ polyether seat. 35 Kg/m³ polyether back. Fix upholstery.

ES · Estructura madera maciza. Asiento poliéter 35 Kg/m³. Respaldo poliéter 35 Kg/m³. Tapizado fijo.

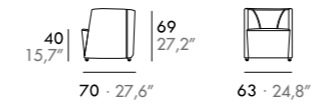





Berna

By José Gras

EN · Solid wood frame. 35 Kg/m³ polyether seat and 35 Kg/m³ polyether back. Fix upholstery.

Option: Berna with varnished wooden base.

ES · Estructura madera maciza. Asiento poliéter 35 Kg/m³. Respaldo poliéter 35 Kg/m³. Tapizado fijo.

Opción: Berna con base de madera barnizada.



Berna Madera



Sunday

By Gabriel Teixidó

EN · Solid wood frame. Nosag springs, seat in “Viscoelastic” extracomfort 55 Kg/m³ “memory effect” foam. Back in a combination of down feather/polyether. Fix upholstery. Optional removable covers (Sunday fun). Optional: Knock down arms.

ES · Estructura madera maciza. Muelles Nosag, asiento viscoelástico (poliéter extraconfort de 55 Kg/m³ “efecto retorno”). Respaldo combinación de pluma/poliéter. Tapizado fijo. Opción desenfundable (Sunday fun). Opción: brazos desmontables.

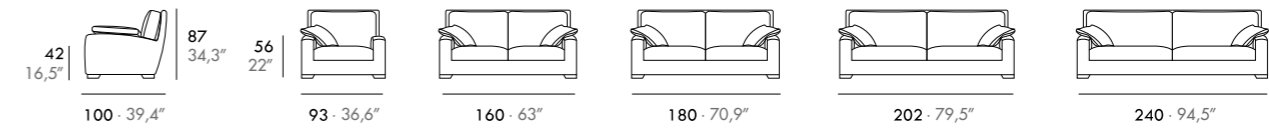



Hero '06

By José Gras

EN · Metallic frame anticorrosion painted, covered by polyether. Removable back frame. Suspension by metallic springs with three options to choose: soft, middle or firm. Seat in viscoelastic 55 Kg/m³ “memory effect” foam and base 35 Kg/m³ polyether (cfc Free). Back in 100% antiallergic hollow fiber. Feet in beechwood varnished in wenge. Completely removable covers. When it is upholstered in leather it is fixed.

ES · Estructura metálica pintada anticorrosión recubierta de poliéter. Parte superior del respaldo desmontable. Suspensión de muelles con tres opciones a elegir: suave, medio y firme. Asiento de viscoelástico extraconfort “efecto retorno” de 55 Kg/m³ y base de 35 Kg/m³ (sin cfc.) Respaldo 100% fibra antialérgica. Pies de madera de haya barnizada en color wengué. Tapizado totalmente desfundable. Cuando se tapiza en piel va tapizado fijo.

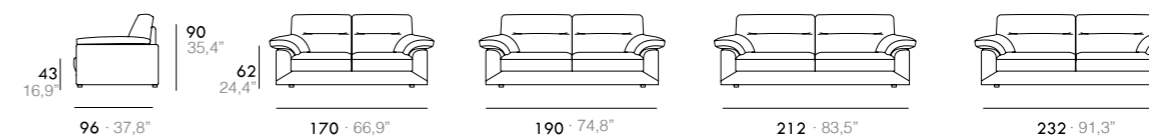



Koly

By Gabriel Teixidó

EN · Solid wood frame. 35 Kg/m³ polyether seat and 30 Kg/m³ polyether back, adjustable headcushion. Fix upholstery. Removable covers optional (Koly Vel).

ES · Estructura madera maciza. Asiento poliéster 35 Kg./m³ y respaldo poliéster 30 Kg/m³, cabezal regulable en altura. Tapizado fijo. Opción desenfundable (Koly Vel).

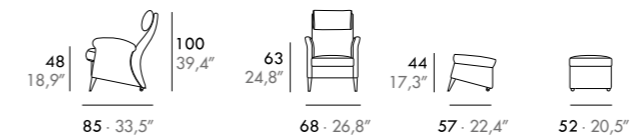



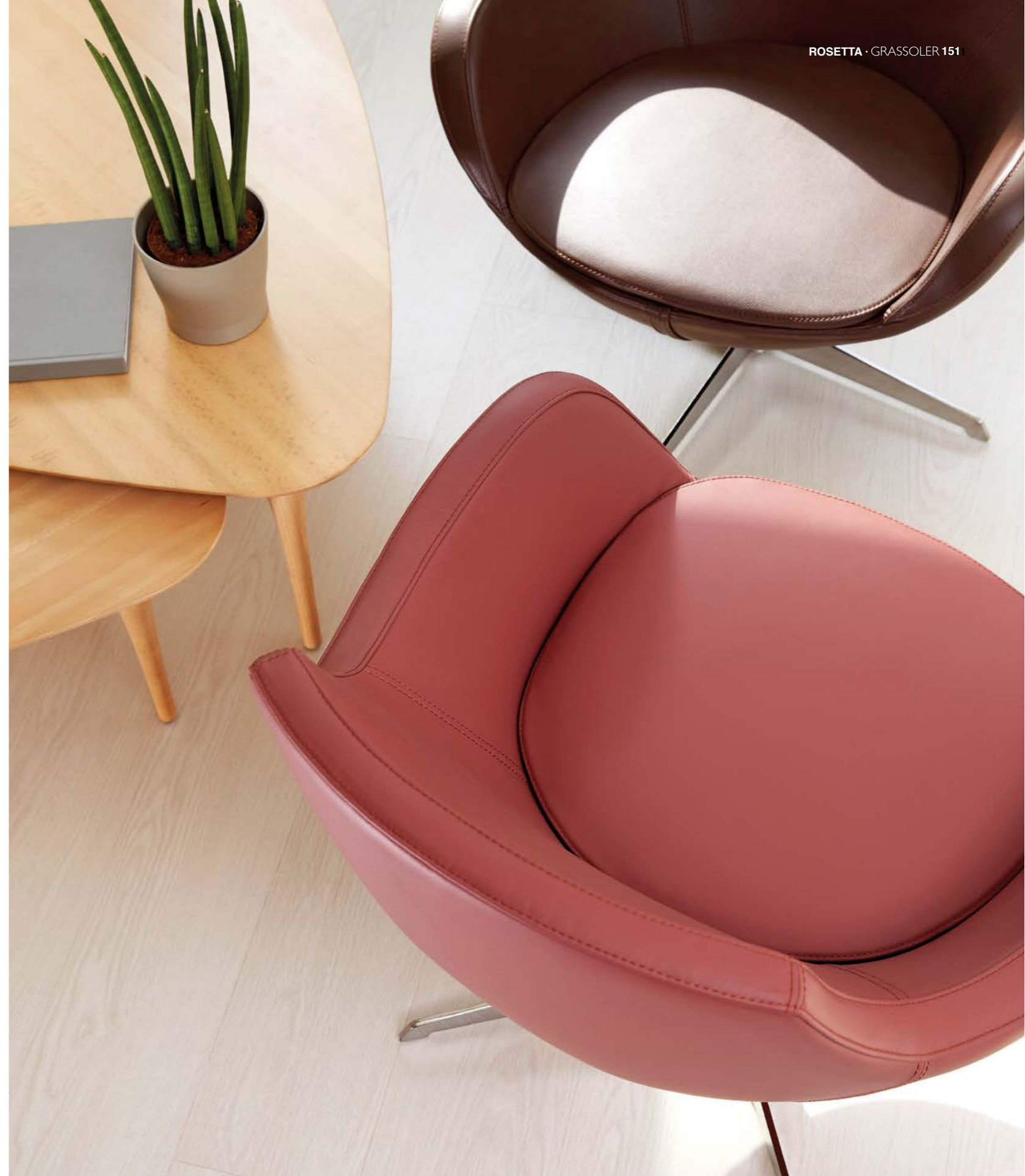



Rosetta

By Grassoler Studio

EN · Cold moulded foam module over metallic frame. Swivel base. Fix upholstery.

ES · Espuma de poliuretano moldeado en frío sobre estructura de acero. Base giratoria. Tapizado fijo.

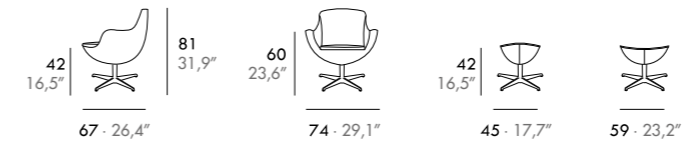





Riverso

By Grassoler Studio

EN · Cold moulded foam module over metallic frame. Option: feet in solid beechwood varnished. Swivel metallic base. Fix upholstery.

ES · Espuma de poliuretano moldeado en frío sobre estructura de acero. Opción: Pies en madera maciza de haya barnizada. Base metálica giratoria. Tapizado fijo.

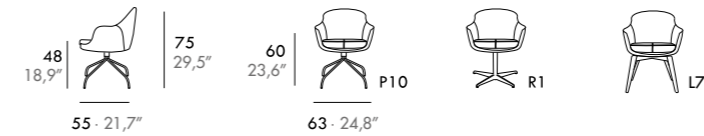



Parody

By Gabriel Teixidó

EN · Solid wood frame. 35 Kg/m³ polyether seat and 24 Kg/m³ polyether back and kidney cushion. Beechwood feet varnished in wengue. Option: Beechwood feet with chromed metallic covering. Fix upholstery.

ES · Estructura madera maciza. Asiento poliéster 35 Kg/m³, respaldo y riñonera poliéster 24 Kg/m³. Pies en madera de haya barnizada en color wengué. Opcion: Pies en madera de haya cubierto de chapa metálica cromada. Tapizado fijo.

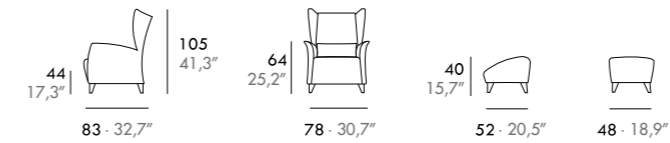



Parade

By Gabriel Teixidó

EN · Solid wood frame. 35 Kg/m³ polyether seat and 34 Kg/m³ + 18 Kg/m³ polyether back. Beechwood feet varnished in wengue. Option: Beechwood feet with chromed metallic covering. Fix upholstery.

ES · Estructura madera maciza. Asiento poliéter 35 Kg/m³, respaldo poliéter 34 Kg/m³. + 18 kg/m³. Pies en madera de haya varnizada en color wengué. Opcion: Pies en madera de haya cubierto de chapa metálica cromada. Tapizado fijo.

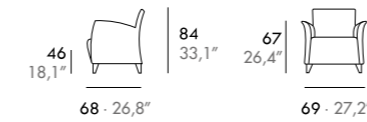



Parcel

By Gabriel Teixidó

EN · Solid wood frame. 35 Kg/m³ polyether seat and 34 Kg/m³ + 18 Kg/m³ polyether back. Beechwood feet varnished in wengue. Option: Beechwood feet with chromed metallic covering. Fix upholstery.

ES · Estructura madera maciza. Asiento poliéster 35 Kg/m³, respaldo poliéster 34 Kg/m³. + 18 kg/m³. Pies en madera de haya varnizada en color wengué. Opcion: Pies en madera de haya cubierto de chapa metálica cromada. Tapizado fijo.

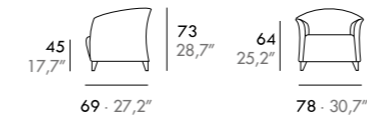



Perla

By José Gras

EN · Solid wood frame, 35 Kg/m³ polyether seat and 30 Kg/m³ polyether back. Beechwood feet with chromed metallic covering. Fix upholstery, optional removable cover (Perla faldón).

ES · Estructura madera maciza. Asiento poliéter 35 Kg/m³ y respaldo poliéter 30 Kg/m³. Pies en madera de haya cubierto de chapa metálica cromada. Tapizado fijo, opción desenfundable (Perla faldón).

Perla

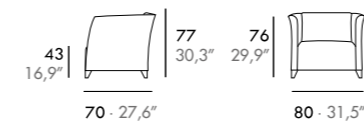

Perla faldón

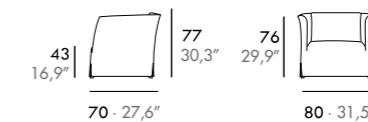

Perla



Perla faldón



Place

By Gabriel Teixidó

EN · Solid wood frame. 35 Kg/m³ polyether seat and 24 Kg/m³ polyether back and kidney cushion. Beechwood feet varnished in wengue. Option: Beechwood feet with chromed metallic covering. Fix upholstery.

ES · Estructura madera maciza, asiento poliéster 35 Kg/m³. Respaldo y riñonera poliéster 24 Kg/m³. Pies en madera de haya varnizada en color wengué. Opcion: Pies en madera de haya cubierto de chapa metálica cromada. Tapizado fijo.

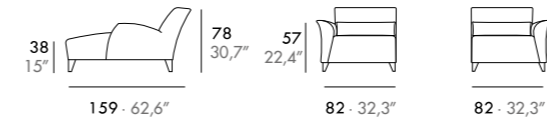



Fortune

By A. Fiorini

EN · Estructura de madera maciza de pino recubierta de poliéster. Suspensión mediante cinchas elásticas de NEA. Asiento de poliéster de 35 kg/m³ (sin cfc), recubierto de guata. Respaldo y cabezal de poliéster de 25 kg/m³ (sin cfc), recubierto de guata.

Pies de madera de haya barnizados o de base metálica cromada. Mecanismo eléctrico multiposicional en asiento y cabezal. Tapizado fijo. Opción: cosido contrastado.

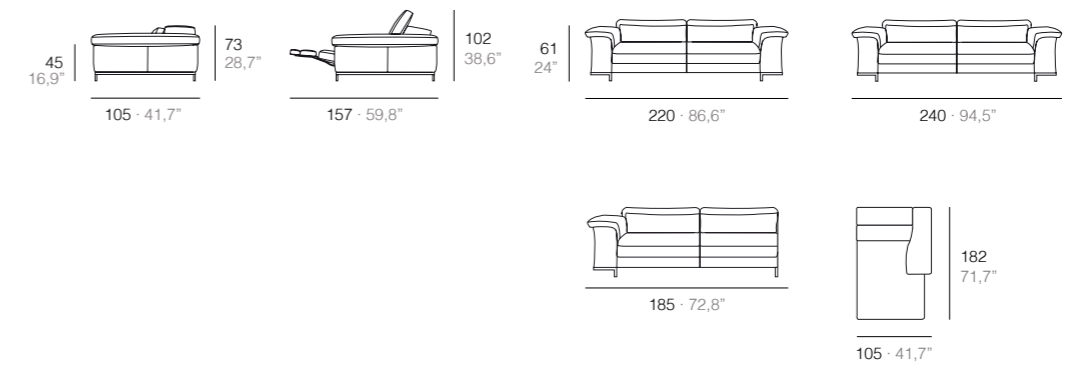



Goby

By José Gras

EN · Estructura de madera maciza de pino recubierta de poliéster. Suspensión con bastidor de muelles metálicos "Nosag". Asiento de Poliéster de 35 kg/m3 (sin cfc).

Respaldo y cabezal de poliéster de 25 kg/m3 (sin cfc). Pies de madera de haya barnizada en color wengué. Mecanismo eléctrico multiposicional en asiento y cabezal. Tapizado fijo. Cojines desenfundables.

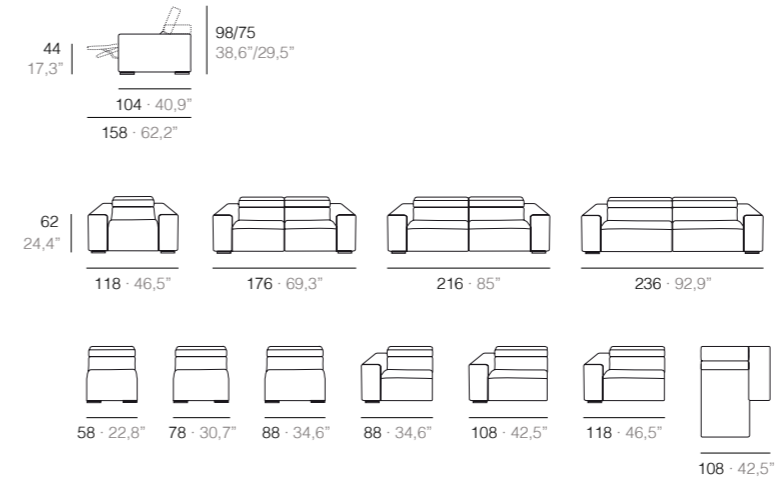





Rhapsody

By José Gras

EN · Estructura de Madera maciza de pino recubierta de poliéster. Cuando va con motores eléctricos la estructura es modular. Cuando se trata de un sofá sin motores, la estructura es de una sola pieza. Suspensión mediante cinchas elásticas entrelazadas. Asiento de poliéster de 35

Kg. (sin cfc.) + visco recubierto de guata. Respaldo y cabezal de poliéster de 25 kg/m3 (sin cfc) recubierto de guata acrílica. Mecanismo eléctrico multiposicional en asiento y cabezal. Pies de madera de haya barnizada en color wengué. Tapizado fijo. Cojines desenfundables.

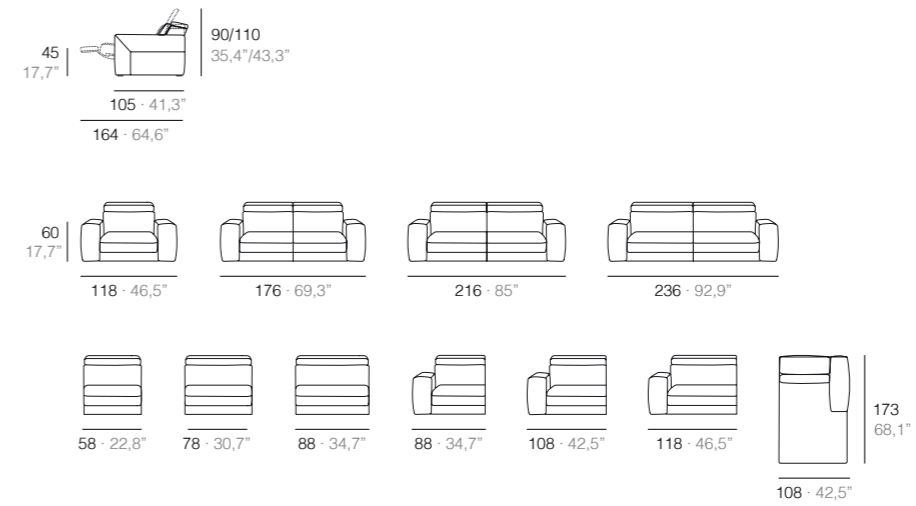



Romulus

By José Gras

ES · Estructura metálica pintada anticorrosión. Brazos de madera. Suspensión mediante cinchas entrelazadas. Asiento de poliéster de 35 Kg. (sin cfc) + visco extraconfort "efecto retorno". Recubierto de guata acrílica. Respaldo y

cabezal de poliéster de 23 Kg. (sin cfc.), recubierto de guata acrílica. Pies metálicos pintados color negro. Mecanismo eléctrico multiposicional en asiento y cabezal. Estructura tapizada fija.

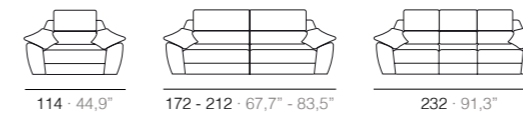
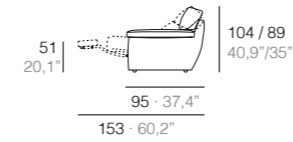

**Grassoler
collection.**

**Visit our
website for
more details.**

La colección
Grassoler

Visita nuestra
web para más
detalles.

Grassoler collection

La colección Grassoler

by Grassoler

EN · FAMILIES

All our products are grouped all the products in clear concepts, easy to position and communicate.



MMS Intelligent System Family
Familia MMS Intelligent System



Public Spaces
Espacios Públicos



Function + Comfort
Función + Confort



Accessories
Complementos

ES · FAMILIAS

Agrupamos los productos en conceptos claros y fáciles de posicionar y comunicar.



New Romantics
Nuevos Románticos



Contemporary
Contemporáneos



Modern
Modernos



Vintage
Vintage

La evolución de más de 50 años de experiencia

Desde la primera versión del concepto técnico “Intelligent System”, hace más de 50 años, hasta hoy, ha habido una evolución constante y una innovación que nos han traído hasta los modelos actuales. Nunca un sofá ha sido tan robusto, cómodo y versátil como esta colección. Un paso más allá en la forma de entender y construir sofás que aportarán satisfacción durante muchos años.

A development due to more than 50 years of experience

Since the first version of the “Intelligent System” technical concept that was presented more than 50 years ago, there have been constant development and innovation, which have brought us to the present collection. A sofa has never been so resistant, comfortable and versatile as in this program. A further step in the way of understanding and producing sofas that bring comfort for many years.

MMS Intelligent System Family Familia MMS Intelligent System

by Grassoler



Transit



Traffic



Thunder



Triumph



Tulsa

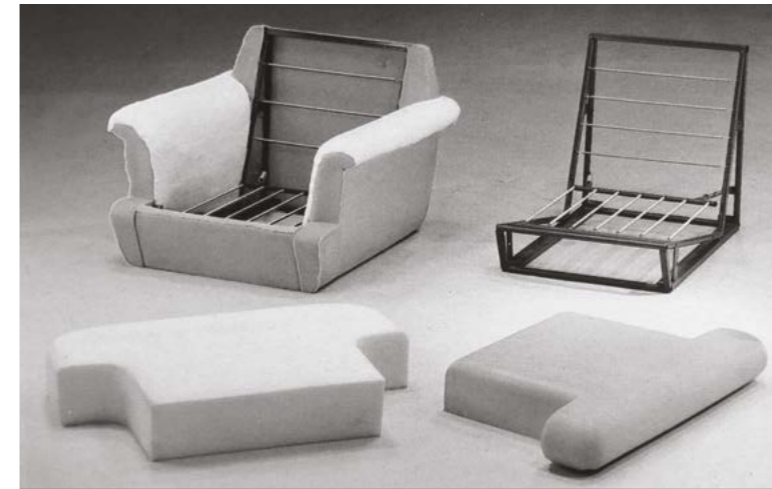

1963 - Davis



2018 - Thunder

- 1 Backrest elevated cushion 8 / 12 cm
Elevador de respaldo 8/12 cm.
- 2 Seat inclination 8 cm
Inclinación de asiento 8 cm
- 3 Easy to disassemble
Totalmente desmontable
- 4 "Tailor made suspension"
"Suspensión a la carta"
- 5 Easy cleaning
Fácil limpieza
- 6 Removable upholstered covers
Totalmente desenfundable
- 7 Steel frames, 25 year warranty
Estructuras metálicas, 25 años de garantía

Cuando lo romántico se vuelve moderno

When romanticism becomes modern

Siempre nos han gustado los sofás con las fundas caídas, los cojines con arrugas y un confort espectacular.

Esta colección habla por si sola, pero también de ti y del espacio donde se ubica. Si te gusta, te enamora. Para perfiles sibaritas.

La estética de estas fundas la hacen especialmente adecuada en sofás de asiento de pluma y respaldos de fibra. Estos modelos son adecuados en telas que acentúan su estilo romántico, a la vez que fresco, como las tapicerías de la Colección Naturales, y cualquier tela tipo algodón o similar al lino.

We always liked sofas with very wide falling covers, with very soft cushions and incredible comfort.

This collection speaks for itself, but also about you and the area where you place it. If you like it, you will love it. For stylish people.

This “romantic style” looks beautiful on sofas with feather seat cushions, fibre back cushions and wide loose covers.

These models are suited for fabrics that improve this romantic flair, such as fabrics belonging to “Colección Naturales” and any other made of cottons, linen or similar with a fresh and natural look.

New Romantics Nuevos románticos

by Grassoler



Nicolay



Nicolay



Perla Faldón



Thunder - Brazo Triumph

Espacios públicos multiusos, ahora más confortables

Robustos, en todos sus aspectos. Diseños compactos, sin elementos sueltos, espumas firmes, sin renunciar al confort y al diseño. Cada uno con una personalidad que se adapta a cada espacio. Desde las formas orgánicas, hasta las líneas más depuradas o la versatilidad de los sofás modulares. Son modelos para instalar y despreocuparse, porque aportan la durabilidad que requiere el mobiliario destinado a uso colectivo.

Multiuse public areas, now more comfortable

Solid, in all aspects. Compact designs, without loose elements, with firm foams, without sacrificing comfort and design. Each with a personality that fits perfectly in a special space. From the organic lines to the pure designs or versatility of our sectionals. Sofas to place that do not need any special care. With this collection we reach the durability required for the furniture designed for the collective use.

Public Spaces Espacios Públicos

by Grassoler



Cayman



Cuc



Intruder



Invader



Elder



Mad



Euphoria XXI



Eudos



Glamour



Open Air



Open Air Vintage



Every



Pasarela



Hexa



Rosetta



Every Madera



Every Vintage



Global



Charme



Inbol



Opalina



Berna



Berna Madera



Berlin



Opal



Parcel



Parcel Madera



Artemis



Interval



Riverso



Paneck



Parody



Parade

Diseños de siempre... para siempre.

Si priorizas la calidad por encima de todo y quieres un sofá con la tranquilidad que hoy, mañana y siempre encajará en cualquier estilo, esta es tu colección. Diseños que no pasan de moda, para garantizarte que siempre estarán, junto con su calidad, perfectos.

Timeless designs.... for ever.

When quality is the biggest priority and someone wants a reliable sofa that will look good in any decoration or style, today, tomorrow and in the future, then this is the perfect collection. Designs that do not go "out of fashion", to assure that they will always remain perfect, along with quality.

Contemporary Contemporáneos

by Grassoler



Definy



Jack



Dakota



Hero '06



Durban



Sunday



Parcel



Parcel Madera



Parade



Paneck



Parody



Berna



Glamour



Inbol



Place

Cuando los mecanismos se unen a la tradición de la tapicería

Funcionalidad es una de las palabras clave, que nos ha llevado a innovadores sistemas para regular los respaldos y reposapiés. Las funciones tecnológicas se combinan con el confort. Con los mecanismos de relax, todo está pensado para garantizar el máximo confort.

(Estos modelos están solo disponibles en España)

When motorized get together with upholstery tradition

“Functional” is one of the key words, that has brought us to develop innovative systems to adjust backs and seats for a better relax. Technological functions are combined with comfort. In “relax-mechanisms” everything has been studied to grant maximum comfort.

(This models are only available in Spain).

Function + Comfort Función + Confort

by Grassoler



Fortune



Romulus



Goby



Mildred



Rhapsody



Independent electrical mechanisms
Mecanismos eléctricos independientes

Modernos, elegantes, robustos

Actuales y sin estridencias, de diseño muy depurado y elegante. Siguiendo las nuevas tendencias hemos incorporado mucha madera en los pies. Así como los pies metálicos pintados en colores Ral a juego con la tapicería o en blanco.

Modern, elegant, strong....

With a very elegant, depurate and clean design. Following the latest trends we have used a lot of wood for the feet. Nevertheless, they are also available with painted metallic feet in Pantone colors matching each fabric or in white.

Modern Modernos by Grassoler



Odissey



Boy



Oracle



Oxygen



Onix



Sapore



Daris



Deep 87



Mad



Kanel



Madalena



Riverso



Pasarela



Hexa



Rosetta



Charme



Opal



Accessories Complementos by Grassoler



Cojines



Cubic



Plaids



Lavanda



Menta



Hiru, Hirusta



Madalena



Wasabi



Salvia



Cabezales



Cabeceros

Elegantes y clásicos con un toque vanguardista

Inspirados en los años 40-50, de estilo puro y corte clásico pero con detalles vanguardistas. Botones, capitoné, terciopelos, madera... sofás realizados con gran cuidado que evocan la estética de épocas pasadas, inspirados en los clásicos. Combinados con elementos contemporáneos, resultan en un ambiente sofisticado y novedoso lleno de personalidad.

Elegant and classic designs with a touch of vanguardism

Inspired in the 40's and 50's, with a depurated style and a classical touch but with vanguardism details. Buttons, capitoné, velvet, wood... sofas made with big care, that evoke the style of past times, inspired in classics. Combined with contemporary elements, they turn out in sophisticated and trendy ambients, full of personality.

Vintage Vintage by Grassoler



Every madera



Open Air Vintage



Berna madera



Parcel madera



Elder Vintage



“Our values, our quality are essential part of our brand, are our identity”

“Nuestros valores, nuestra calidad son parte esencial de nuestra marca, son nuestra identidad”