



UNIQUE

ZAPATEROS / SHOERACKS

by franco furniture



UNIQUE

by franco furniture

El *Tigre Blanco* es considerado una criatura mitológica. La probabilidad de que nazca de forma natural es de 1 entre 10.000 lo que lo hace *único en el mundo*.

En la actualidad existen tan solo 200 ejemplares en el mundo ubicados entre el sureste de Asia y en el centro y sur de la India. En la mitología japonesa, denominado BYAKKO, hace referencia a uno de los cuatro monstruos que se veneran como divinos, representando cada uno de ellos un punto cardinal. Correspondiendo al tigre blanco el Oeste. Su pelaje *representa la pureza, la fuerza y la transparencia*.

Así es *UNIQUE* la nueva línea de zapateros de Franco Furniture. *Una colección de diseño única*.

Por primera vez en nuestra historia hemos lanzado a mercado una edición especial de zapateros cuyo diseño traza una nueva línea *que supone un cambio de era en nuestra firma*.

Elegancia, distinción y estilo inundan cada detalle.



Franco Furniture

UNIQUE

by franco furniture



pág. 06



pág. 39

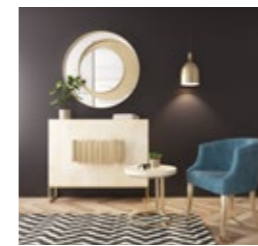

pág. 40



pág. 43



pág. 43



pág. 44

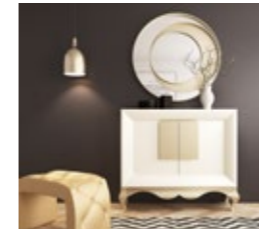

pág. 46



pág. 47



pág. 48



pág. 49



pág. 50



pág. 52

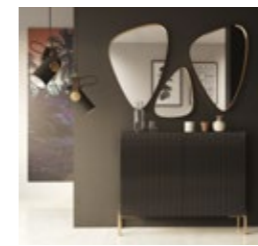

pág. 54



pág. 57



pág. 58



pág. 60

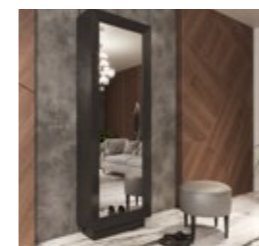

pág. 62



pág. 64

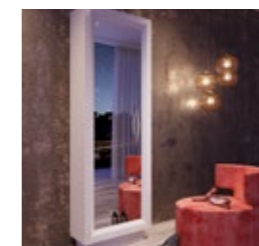

pág. 66

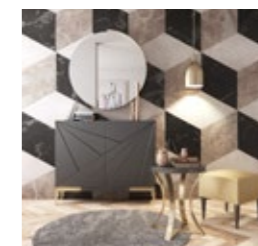

pág. 68



pág. 71

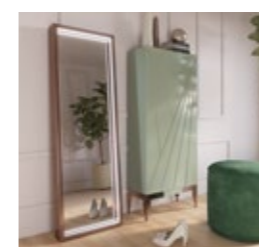

pág. 73

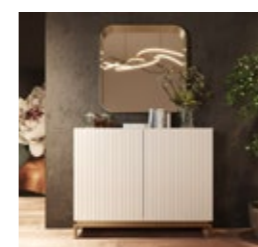

pág. 74

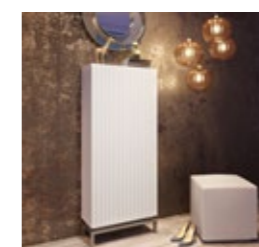

pág. 77

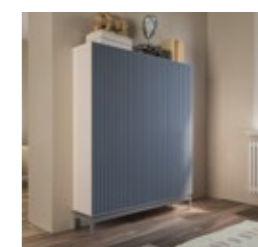

pág. 78

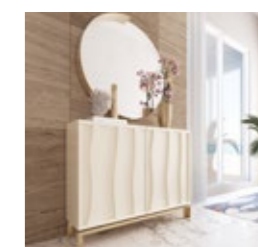

pág. 80



pág. 82

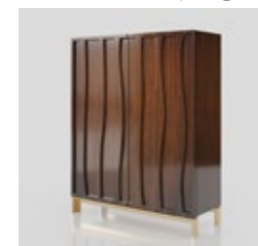

pág. 83

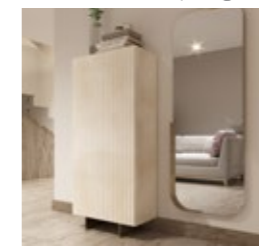

pág. 84



pág. 86



pág. 88



pág. 08

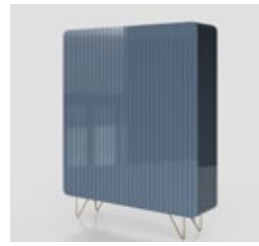

pág. 10



pág. 11



pág. 13



pág. 13



pág. 15



pág. 17



pág. 19



pág. 20



pág. 22

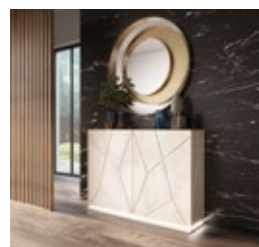

pág. 24



pág. 26

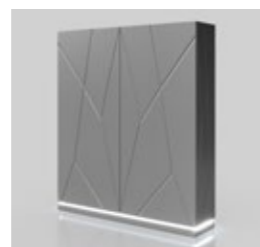

pág. 27



pág. 28



pág. 29



pág. 30



pág. 32



pág. 33



pág. 34



pág. 36



U01



U01

Ref. 54702 Zapatero

Color 288 Alto Brillo

Color 041

Capacidad 15 pares

Precio: **712€**

Ref. 21015 Espejo

Color 041

Precio: **258€**



UO2
Ref. 54700 Zapatero
Color 288 Alto Brillo
Color 041
Capacidad 18 pares
Precio: **872€**

Ref. 21014 Espejo 2uds.
Color 041
Precio: **500€**



UO2

UO3

Ref. 54701 Zapatero
Color 242 Alto Brillo
Color 041
Capacidad 30 pares
Precio: **974€**

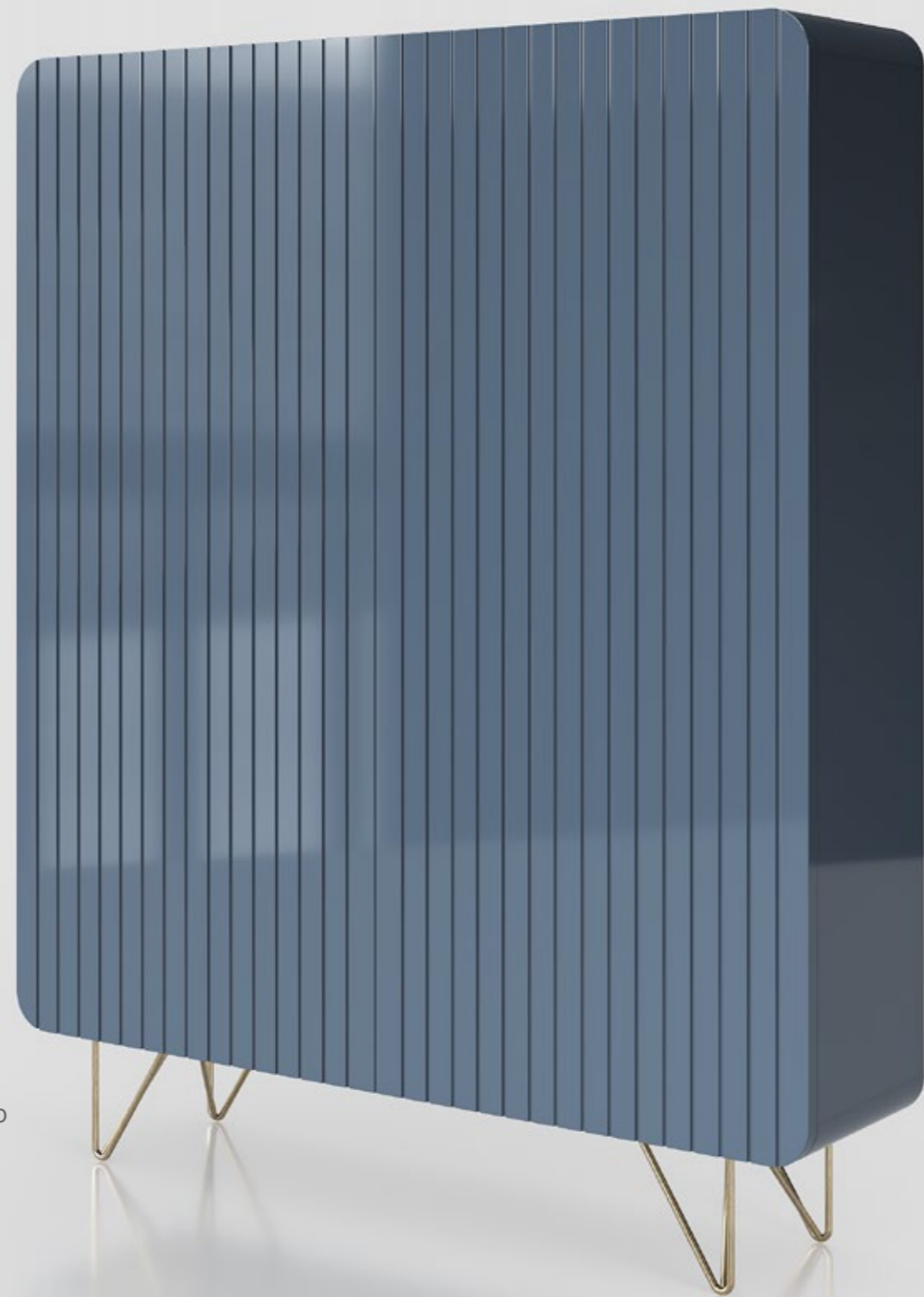

UO4

Ref. ZA0160261 Zapatero
Color 120
Color 041
Capacidad 18 pares
Precio: **836€**

Ref. 21032 Espejo
Color 041
Precio: **319€**



U04



U05

Ref. ZA0160263
Zapatero
Color 120
Color 041
Capacidad 15 pares
Precio: **783€**

Ref. 58531 Espejo
Color 041
Precio: **274€**



U06

Ref. ZA0160262
Zapatero
Color 141
Color 043
Capacidad 30 pares
Precio: **1.014€**

U05



ÚNICOS

Elegancia y Belleza
 como resultado de la
 combinación perfecta
 entre materiales de calidad,
 acabados sublimes
 y un diseño sofisticado

U04



U07

Ref. 61000 Zapatero
 Color 150
 Color 040
 Capacidad 18 pares
 Precio: **707€**

Ref. 21042 Espejo
 Color 040
 Precio: **342€**



U07



U08

Ref. 61001 Zapatero
Color 288 Alto Brillo
Color 041
Capacidad 30 pares
Precio: **964€**





U08

U09

Ref. 60265 Zapatero
Color 150
Color 043
Capacidad 30 pares
Precio: **821€**





U11



U11

Ref. 60266 Zapatero
Color 120
Color 041
Capacidad 15 pares
Precio: **608€**

Ref. 21030 Espejo
Color 041
Precio: **293€**

Ref. 42092 Banqueta
Precio: **291€**



NOVEDOSOS

Diseños que serán los nuevos protagonistas
de cualquier estancia

¿Desde cuando un zapatero había cautivado todas las miradas?



U12

U12

Ref. 57714 Zapatero
Color 121
Color 041
Capacidad 18 pares
Precio: **703€**
Recargo Luz Led **106€**

Ref. 21062 Espejo
Color 041
Precio: **307€**



U13

Ref. 57716 Zapatero

Color 150

Capacidad 15 pares

Precio: **518€**

Recargo Luz Led **98€**

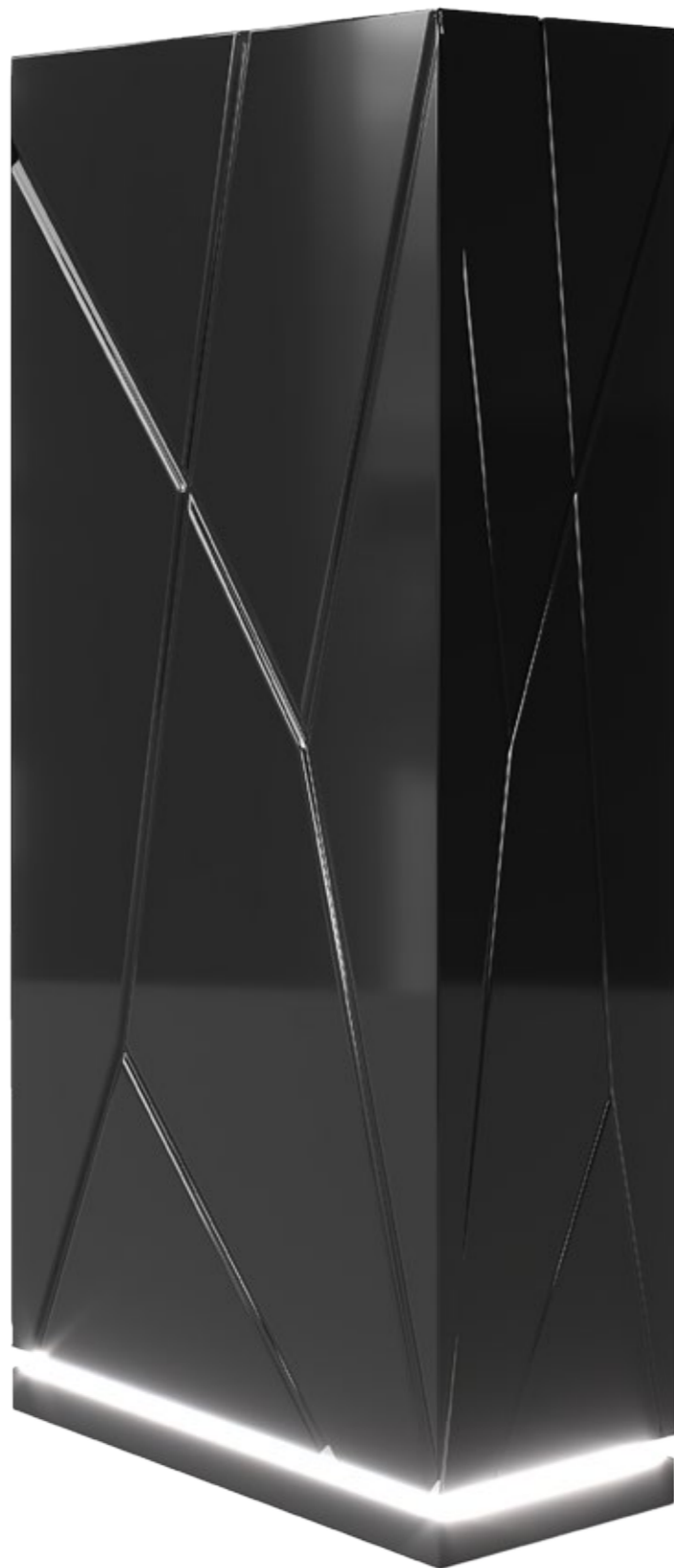

U14

Ref. 57715 Zapatero

Color 046

Capacidad 30 pares

Precio: **817€**

Recargo Luces Led **106€**

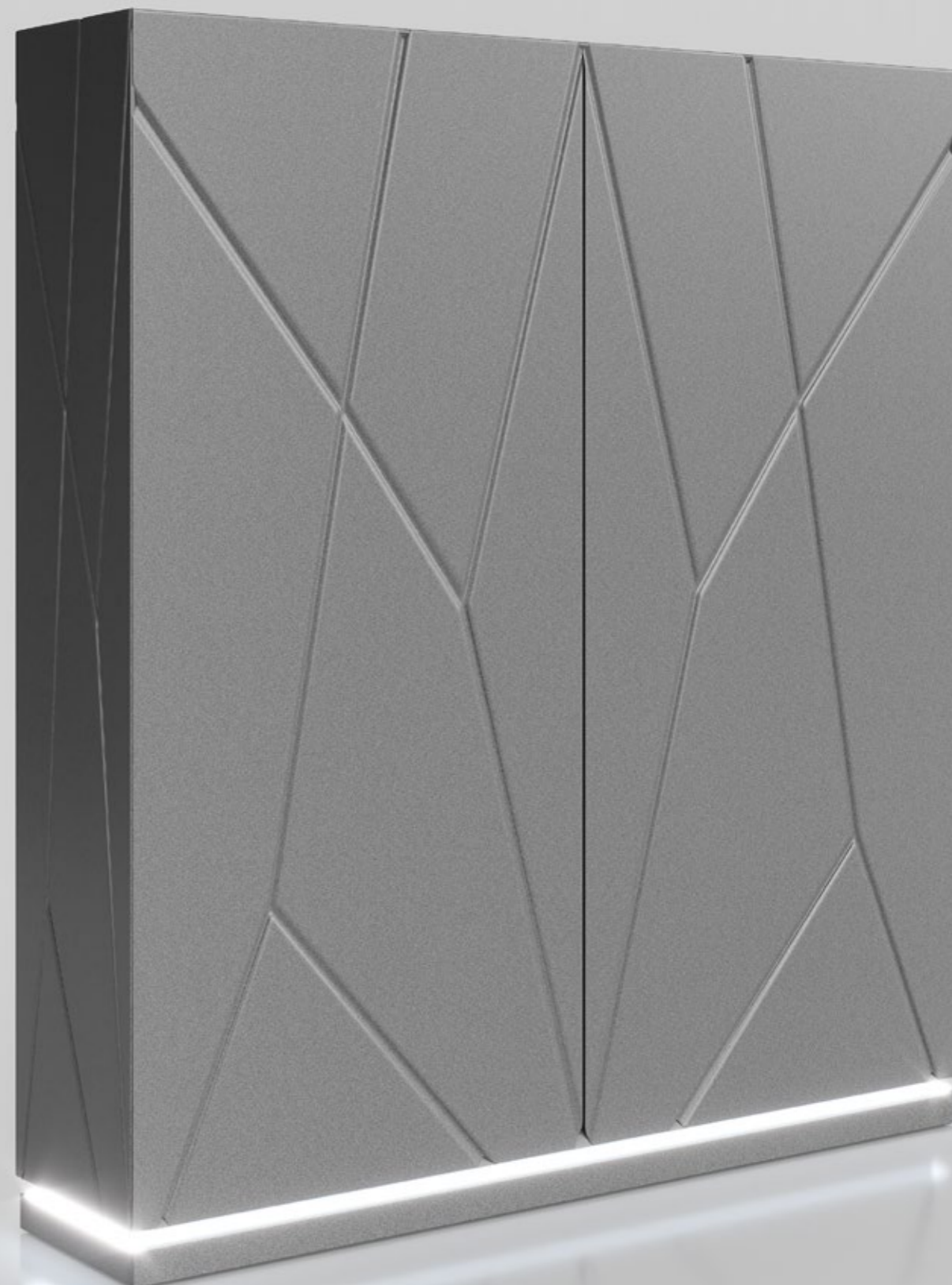



U15

Ref. 48781 Zapatero
Color 162
Color 142
Tirador Plata Vieja
Capacidad 18 pares
Precio: **655€**

Ref. 48873 Espejo
Color 162
Precio: **205€**



U15

U16

Ref. 48782 Zapatero
Color 142
Color 162
Tirador Plata Vieja
Capacidad 24 pares
Precio: **732€**



IMPRESCINCIBLE

Un básico que transformará
ese espacio vacío
en un rincón con encanto



U18

Ref. ZA0360263
Zapatero
Color 120
Color 041
Capacidad 15 pares
Precio: **602€**

Ref. 21049 Espejo
Color 041
Precio: **325€**



U18



U19

Ref. ZA0360262
Zapatero
Color 142
Color 043
Capacidad 30 pares
Precio: **807€**



U20



U20

Ref. 60267 Zapatero

Color 120

Color 040

Capacidad 18 pares

Precio: **624€**

Ref. 21035 Juego Espejos

Color 040

Precio: **500€**

U21

Ref. 60268 Zapatero

Color 152

Color 041

Capacidad 30 pares

Precio: 775€

Ref. 40806 Silla

Precio: 386€

Ref. 58489 Juego Mesas

Tapa Mármol

Color 041

Precio: 1025€



U21



QUIÉN

¡Atención! Sólo apto para los gustos más exquisitos, extraordinarios y refinados.

U22

Ref. 60269 Zapatero
Color 150
Color 041
Capacidad 15 pares
Precio: **551€**



U23



U23

Ref. ZA0260261 Zapatero

Color 121

Color 041

Capacidad 18 pares

Precio: **703€**

Ref. 21062 Espejo

Color 041

Precio: **307€**

Ref. 48884 Sillón

Precio: **378€**

Ref. 54411 Mesita

Color 121

Color 041

Precio: **366€**



U23



U25

Ref. ZA0260263 Zapatero
Color 123
Color 044
Capacidad 15 pares
Precio: **657€**



U24

Ref. ZA0260262 Zapatero
Color 150
Color 040
Capacidad 30 pares
Precio: **866€**



U26

Ref. ZA0460261 Zapatero
Color 162
Color 040
Capacidad 18 pares
Precio: **565€**

Ref. 21054 Espejo
Color 040
Precio: **291€**

Ref. 45355 Banqueta
Precio: **346€**

Ref. 54412 Mesita
Color 162
Color 040
Precio: **366€**

U26



U27

Ref. 45017 Zapatero
Color 162
Color 184
Capacidad 18 pares
Precio: **931€**

Ref. 21062 Espejo
Color 184
Precio: **307€**

Ref. 45353 Banqueta
Precio: **354€**



ÚTILES

Al fin y al cabo lo importante está en el interior. Diseñados para aprovechar al máximo el espacio.

U28

Ref. 45018 Zapatero
Color 150
Color 041
Capacidad 24 pares
Precio: **949€**





U29

Ref. ZA0460263
Zapatero
Color 120
Color 040
Capacidad 15 pares
Precio: **508€**

Ref. 21015 Espejo
Color 040
Precio: **258€**

Ref. 45364 Banqueta
Precio: **193€**



U29

U30

Ref. ZA0460262 Zapatero
Color 141
Color 041
Capacidad 30 pares
Precio: **714€**





U31

Ref. 45588 Zapatero

Color 120
Roseta Cromada

Cristal Fume

Capacidad 18 pares

Precio: **712€**

Ref. 46020 Espejo

Color 120

Precio: **236€**

U32



U32
Ref. 45589
Zapatero
Color 120
Roseta Cromada
Cristal Fume
Capacidad 24 pares
Precio: **760€**

Ref. 45357 Banqueta
Precio: **211€**





U33

Ref. ZA0160500
Zapatero
Color 288 Alto Brillo
Color 041
Capacidad 18 pares
Precio: **829€**

Ref. 21035 Juego Espejos
Color 041
Precio: **500€**



U33



U33



U34

Ref. ZA0160501
Zapatero
Color 146
Color 041
Capacidad 30 pares
Precio: **844€**

U35

Ref. ZA0160502

Zapatero

Color 162

Color 041

Capacidad 15 pares

Precio: **561€**

Ref. 21030 Espejos

Color 041

Precio: **293€**



U35

U36



U36

Ref. 45587
Zapatero
Color 120
Capacidad 21 pares
Precio: **712€**

Ref. 45359 Sillón
Precio: **549€**

U37

Ref. 53000
Zapatero
Color 188
Capacidad 21 pares
Precio: 712€

Ref. 45357 Banqueta
Precio: 211€



U37



U38



U38

Ref. 58115 Zapatero
Color 120
Capacidad 21 pares
Precio: **712€**

Ref. 45358 Banqueta
Precio: **285€**

U39

Ref. 48783 Zapatero

Color 120

Capacidad 21 pares

Precio: **712€**

Ref. 45355 Banqueta

Precio: **346€**



U39



U40

MAKE YOUR HOME AMONG FRIENDS
HOW DOES SHE FEEL

U40

Ref. 60272
Zapatero
Color 147
Color 041
Capacidad 18 pares
Precio: **783€**

Ref. 21054 Espejo
Color 041
Precio: **291€**

Ref. 54473 Mesita
Color 147
Color 041
Precio: **439€**

Ref. 45354 Banqueta
Precio: **211€**



U40



U41
Ref. 60273
Zapatero
Color 120
Color 043
Capacidad 30 pares
Precio: **923€**

Ref. 45363 Banqueta
Precio: **224€**



U41



U42

Ref. 60274 Zapatero
Color 141
Color 043
Capacidad 15 pares
Precio: **669€**

Ref. 57711 Espejo
Color 043
Precio: **248€**
Recargo Luz Led **171€**

Ref. 45361 Puff
Precio: **193€**



EXCLUSIVOS

By Franco Furniture. Líneas que reflejan un cambio de era manteniendo la esencia de nuestra firma.

U43

Ref. 60401 Zapatero
Color 120
Color 041
Capacidad 18 pares
Precio: **596€**

Ref. 21002 Espejo
Color 041
Precio: **268€**



U43



U43



U44

Ref. 60403 Zapatero
Color 120
Color 040
Capacidad 15 pares
Precio: **561€**

Ref. 21060 Espejo
Color 040
Precio: **285€**

Ref. 45364 Puff
Precio: **193€**



U45

Ref. 60402 Zapatero
Color 152
Color 142
Capacidad 30 pares
Precio: 764€



U45



U46



U46

Ref. 60600 Zapatero

Color 162

Color 041

Capacidad 18 pares

Precio: **632€**

Ref. 21054 Espejo

Color 041

Precio: **291€**



U47

Ref. 60602 Zapatero
Color 150
Color 040
Capacidad 15 pares
Precio: **561€**

Ref. 21049 Espejo
Color 040
Precio: **325€**



U47

U48

Ref. 60601 Zapatero
Color 143
Color 041
Capacidad 30 pares
Precio: **744€**





U49

Ref. ZA0260502

Zapatero

Color 162

Color 041

Capacidad 15 pares

Precio: **561€**

Ref. 21015 Espejo

Color 041

Precio: **258€**



U49



Ref. ZA0260501 Zapatero
Color 288 Alto Brillo
Color 041
Capacidad 30 pares
Precio: **929€**

U50



U50

U51



U51

Ref. ZA0260500
Zapatero
Color 120
Color 040
Capacidad 18 pares
Precio: **608€**

Ref. 21032 Espejo
Color 040
Precio: **319€**

| | ANCHO | ALTO | FONDO | VOL | PAG | MATE | FRENTE ALTO BRILLO | ALTO BRILLO |
|--|-------|------|-------|-----|-----|------|--------------------|-------------|
| | cm | | | m3 | UD | | | |

U01 - 288 ALTO BRILLO + 041 METALIZADO (APERTURA A IZQUIERDA)

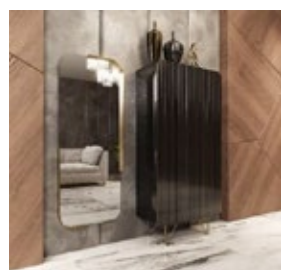

| | | | | | | | | |
|--------------------------------|----------------------------------|-----|----|------|----------|--------------|--------------|--------------|
| 54702 | ZAPATERO KRYSTAL 1 PUERTA DUELAS | | | | 106 | 280 | 308 | 350 |
| | 60 | 140 | 29 | 0,32 | 1 | 569 € | 626 € | 712 € |
| 21015 | ESPEJO SEMIMETALICO MARCO CURVO | | | | 120 | 127 | | |
| | 50 | 135 | 5 | 0,08 | 1 | 258 € | | |
| TOTAL ZAPATERO + ESPEJO | | | | | | 407 | 435 | 477 |
| | | | | | | 827 € | 884 € | 970 € |



15 PARES

U02 - 288 ALTO BRILLO + 041 METALIZADO

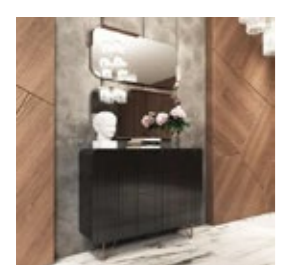

| | | | | | | | | |
|--------------------------------|--|-----|----|------|----------|----------------|----------------|----------------|
| 21014 | ESPEJO SEMIMETALICO MARCO CURVO | | | | 120 | 246 | | |
| | 50 | 100 | 5 | 0,06 | 2 | 500 € | | |
| 54700 | ZAPATERO KRYSTAL FUELLE 2 PUERTAS DUELAS | | | | 105 | 343 | 377 | 429 |
| | 120 | 100 | 29 | 0,45 | 1 | 697 € | 766 € | 872 € |
| TOTAL ZAPATERO + ESPEJO | | | | | | 589 | 623 | 675 |
| | | | | | | 1.197 € | 1.267 € | 1.372 € |



18 PARES

U03 - 242 ALTO BRILLO + 041 METALIZADO



| | | | | | | | | |
|--------------|-----------------------------------|-----|----|------|----------|--------------|--------------|--------------|
| 54701 | ZAPATERO KRYSTAL 2 PUERTAS DUELAS | | | | 105 | 383 | 421 | 479 |
| | 120 | 150 | 29 | 0,66 | 1 | 779 € | 856 € | 974 € |



30 PARES

U04 - 120 MATE + 041 METALIZADO



| | | | | | | | | |
|--------------------------------|---------------------------------------|-----|----|------|----------|----------------|----------------|----------------|
| 21032 | ESPEJO METALICO PLANETARIO | | | | 120 | 157 | | |
| | 100 | 100 | 3 | 0,09 | 1 | 319 € | | |
| ZA0160261 | ZAPATERO VIENA FUELLE 2 PUERTAS LISAS | | | | 107 | 411 | 452 | 493 |
| | 120 | 100 | 29 | 0,45 | 1 | 836 € | 919 € | 1.002 € |
| TOTAL ZAPATERO + ESPEJO | | | | | | 568 | 609 | 650 |
| | | | | | | 1.155 € | 1.238 € | 1.321 € |



18 PARES

| | ANCHO | ALTO | FONDO | VOL | PAG | MATE | FRENTE ALTO BRILLO | ALTO BRILLO |
|--|-------|------|-------|-----|-----|------|--------------------|-------------|
| | cm | | | m3 | UD | | | |

U05 - 120 MATE + 041 METALIZADO (APERTURA IZQUIERDA)



| | | | | | | | | |
|--------------------------------|---|-----|----|------|----------|----------------|----------------|----------------|
| 58531 | ESPEJO CIRCULAR METALICO DIÁMETRO 60 cm | | | | 118 | 135 | | |
| | 60 | 60 | 10 | 0,06 | 1 | 274 € | | |
| ZA0160263 | ZAPATERO VIENA 1 PUERTA LISAS | | | | 107 | 385 | 424 | 462 |
| | 60 | 140 | 29 | 0,32 | 1 | 783 € | 862 € | 939 € |
| TOTAL ZAPATERO + ESPEJO | | | | | | 520 | 559 | 597 |
| | | | | | | 1.057 € | 1.136 € | 1.214 € |



15 PARES

U06 - 141 MATE + 043 METALIZADO

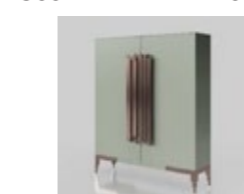

| | | | | | | | | |
|------------------|--------------------------------|-----|----|------|----------|----------------|----------------|----------------|
| ZA0160262 | ZAPATERO VIENA 2 PUERTAS LISAS | | | | 107 | 499 | 549 | 599 |
| | 120 | 150 | 29 | 0,66 | 1 | 1.014 € | 1.116 € | 1.218 € |



30 PARES

U07 - 150 MATE + 040 METALIZADO

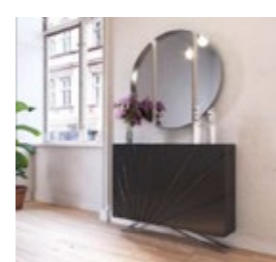

| | | | | | | | | |
|--------------------------------|------------------------------------|-----|----|------|----------|----------------|----------------|----------------|
| 21042 | ESPEJO TRIPLE CIRCULAR METÁLICO | | | | 120 | 168 | | |
| | 100 | 100 | 5 | 0,11 | 1 | 342 € | | |
| 61000 | ZAPATERO FUELLE 2 PUERTAS DESTELLO | | | | 115 | 348 | 383 | 418 |
| | 120 | 100 | 29 | 0,45 | 1 | 707 € | 779 € | 850 € |
| TOTAL ZAPATERO + ESPEJO | | | | | | 516 | 551 | 586 |
| | | | | | | 1.049 € | 1.120 € | 1.191 € |



18 PARES

U08 - 288 ALTO BRILLO + 041 METALIZADO



| | | | | | | | | |
|--------------|-----------------------------|-----|----|------|----------|--------------|--------------|--------------|
| 61001 | ZAPATERO 2 PUERTAS DESTELLO | | | | 115 | 395 | 435 | 474 |
| | 120 | 150 | 29 | 0,66 | 1 | 803 € | 884 € | 964 € |



30 PARES

U09 - 150 MATE + 043 METALIZADO



| | | | | | | | | |
|--------------|--------------------------|-----|----|------|----------|--------------|--------------|--------------|
| 60265 | ZAPATERO 2 PUERTAS LISAS | | | | 110 | 404 | 444 | 485 |
| | 124 | 154 | 33 | 0,78 | 1 | 821 € | 903 € | 986 € |



30 PARES

| | ANCHO | ALTO | FONDO | VOL | PAG | MATE | FRENTE ALTO BRILLO | ALTO BRILLO |
|--|-------|------|-------|-----|-----|------|--------------------|-------------|
| | cm | | | m3 | UD | | | |

U10 - 121 MATE + 041 METALIZADO

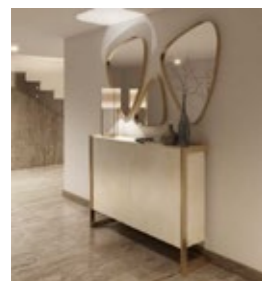

| | | | | | | | | |
|--------------------------------|-----------------------------------|-----|-----|------|----------|----------------|----------------|----------------|
| 60264 | ZAPATERO FUELLE 2 PUERTAS LISAS | | | | 110 | 336 | 370 | 403 |
| | 124 | 104 | 33 | 0,53 | 1 | 683 € | 752 € | 819 € |
| 21035 | JUEGO 3 ESPEJOS METALICOS PIEDRAS | | | | 121 | 246 | | |
| | | | 3,5 | | 1 | 500 € | | |
| TOTAL ZAPATERO + ESPEJO | | | | | | 582 | 616 | 649 |
| | | | | | | 1.183 € | 1.252 € | 1.319 € |



18 PARES

U11 - 120 MATE + 041 METALIZADO (APERTURA IZQUIERDA)



| | | | | | | | | |
|--------------------------------|----------------------------|-----|----|------|----------|--------------|--------------|----------------|
| 60266 | ZAPATERO 1 PUERTA LISAS | | | | 110 | 299 | 329 | 359 |
| | 64 | 144 | 33 | 0,39 | 1 | 608 € | 669 € | 730 € |
| 21030 | ESPEJO METALICO PLANETARIO | | | | 120 | 144 | | |
| | 60 | 60 | 3 | 0,03 | 1 | 293 € | | |
| TOTAL ZAPATERO + ESPEJO | | | | | | 443 | 473 | 503 |
| | | | | | | 901 € | 962 € | 1.023 € |



15 PARES

| | | | | | | | | |
|--------------|----------|----|----|------|----------|--------------|--|--|
| 42092 | BANQUETA | | | | 121 | 143 | | |
| | 50 | 50 | 50 | 0,17 | 1 | 291 € | | |

U12 - 121 MATE + 041 METALIZADO



| | | | | | | | | |
|-------------------------|----------------------------------|-----|----|------|----------|--------------|--------------|--------------|
| 21062 | ESPEJO METALICO ESPIRAL | | | | 121 | 151 | | |
| | 100 | 100 | 5 | 0,11 | 1 | 307 € | | |
| 57714 | ZAPATERO FUELLE AVANTY 2 PUERTAS | | | | 106 | 346 | 381 | 433 |
| | 120 | 86 | 29 | 0,39 | 1 | 703 € | 775 € | 880 € |
| RECARGO ILUMINACION LED | | | | | | | 52 | 52 |
| | | | | | | 1 | 106 € | 106 € |



18 PARES

| | | | | | | | | |
|--------------------------------|--|--|--|--|--|----------------|----------------|----------------|
| TOTAL ZAPATERO + ESPEJO | | | | | | 549 | 584 | 636 |
| | | | | | | 1.116 € | 1.187 € | 1.293 € |

| | ANCHO | ALTO | FONDO | VOL | PAG | MATE | FRENTE ALTO BRILLO | ALTO BRILLO |
|--|-------|------|-------|-----|-----|------|--------------------|-------------|
| | cm | | | m3 | UD | | | |

U13 - 150 MATE (APERTURA IZQUIERDA)



| | | | | | | | | |
|--------------------------------|--------------------------|-----|----|------|----------|--------------|--------------|--------------|
| 57716 | ZAPATERO AVANTY 1 PUERTA | | | | 106 | 255 | 281 | 319 |
| | 60 | 126 | 29 | 0,29 | 1 | 518 € | 571 € | 649 € |
| RECARGO ILUMINACION LED | | | | | | | 48 | 48 |
| | | | | | | 1 | 98 € | 98 € |
| TOTAL ZAPATERO + ESPEJO | | | | | | 303 | 329 | 367 |
| | | | | | | 616 € | 669 € | 746 € |



15 PARES

U14 - 046 METALIZADO

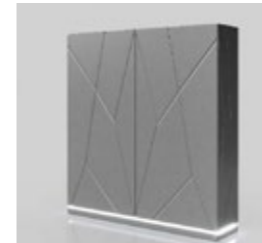

| | | | | | | | | |
|--------------------------------|---------------------------|-----|----|------|----------|--------------|----------------|----------------|
| 57715 | ZAPATERO AVANTY 2 PUERTAS | | | | 106 | 402 | 442 | 503 |
| | 120 | 136 | 29 | 0,60 | 1 | 817 € | 899 € | 1.023 € |
| RECARGO ILUMINACION LED | | | | | | | 52 | 52 |
| | | | | | | 1 | 106 € | 106 € |
| TOTAL ZAPATERO + ESPEJO | | | | | | 454 | 494 | 555 |
| | | | | | | 923 € | 1.004 € | 1.128 € |



30 PARES

U15 - 162 MATE + 142 MATE + TIRADOR PLATA VIEJA



| | | | | | | | | |
|--------------------------------|---|-----|----|------|----------|--------------|--------------|----------------|
| 48781 | ZAPATERO ENZO FUELLE 2 PUERTAS SIMULACION CAJONES | | | | 105 | 322 | 354 | 403 |
| | 120 | 94 | 31 | 0,45 | 1 | 655 € | 720 € | 819 € |
| 48873 | ESPEJO MARCO ENZO | | | | 118 | 101 | | 126 |
| | 100 | 100 | 4 | 0,10 | 1 | 205 € | | 256 € |
| TOTAL ZAPATERO + ESPEJO | | | | | | 423 | 455 | 529 |
| | | | | | | 860 € | 925 € | 1.075 € |



18 PARES

U16 - 142 MATE + 162 MATE + TIRADOR PLATA VIEJA



| | | | | | | | | |
|--------------|--|-----|----|------|----------|--------------|--------------|--------------|
| 48782 | ZAPATERO ENZO 2 PUERTAS SIMULACION CAJONES | | | | 105 | 360 | 396 | 450 |
| | 120 | 135 | 31 | 0,63 | 1 | 732 € | 805 € | 915 € |



24 PARES

| | ANCHO | ALTO | FONDO | VOL | PAG | MATE | FRENTE ALTO BRILLO | ALTO BRILLO |
|--|-------|------|-------|-----|-----|------|--------------------|-------------|
| | cm | | | m3 | UD | | | |

U17 - 120 MATE + 041 METALIZADO



| | | | | | | | | |
|--------------------------------|---------------------------------|-----|----|------|----------|----------------|----------------|----------------|
| ZA0360261 | ZAPATERO FUELLE 2 PUERTAS LISAS | | | | 108 | 333 | 366 | 400 |
| | 120 | 100 | 29 | 0,45 | 1 | 677 € | 744 € | 813 € |
| 21042 | ESPEJO TRIPLE CIRCULAR METÁLICO | | | | 120 | 168 | | |
| | 100 | 100 | 5 | 0,11 | 1 | 342 € | | |
| TOTAL ZAPATERO + ESPEJO | | | | | | 501 | 534 | 568 |
| | | | | | | 1.019 € | 1.086 € | 1.155 € |



18 PARES

U18 - 120 MATE + 041 METALIZADO (APERTURA IZQUIERDA)

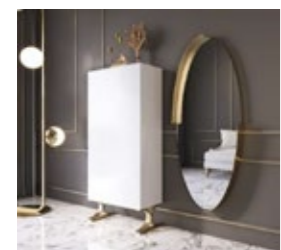

| | | | | | | | | |
|--------------------------------|-----------------------------|-----|----|------|----------|--------------|--------------|----------------|
| ZA0360263 | ZAPATERO 1 PUERTA LISA | | | | 109 | 296 | 326 | 355 |
| | 60 | 140 | 29 | 0,32 | 1 | 602 € | 663 € | 722 € |
| 21049 | ESPEJO OVALADO SEMIMETALICO | | | | 119 | 160 | | |
| | 70 | 170 | 10 | 0,20 | 1 | 325 € | | |
| TOTAL ZAPATERO + ESPEJO | | | | | | 456 | 486 | 515 |
| | | | | | | 927 € | 988 € | 1.047 € |



15 PARES

U19 - 142 MATE + 043 METALIZADO



| | | | | | | | | |
|------------------|--------------------------|-----|----|------|----------|--------------|--------------|--------------|
| ZA0360262 | ZAPATERO 2 PUERTAS LISAS | | | | 108 | 397 | 437 | 476 |
| | 120 | 150 | 29 | 0,66 | 1 | 807 € | 888 € | 968 € |



30 PARES

U20 - 120 MATE + 040 METALIZADO



| | | | | | | | | |
|--------------------------------|-----------------------------------|----|-----|------|----------|----------------|----------------|----------------|
| 21035 | JUEGO 3 ESPEJOS METALICOS PIEDRAS | | | | 121 | 246 | | |
| | | | 3,5 | | 1 | 500 € | | |
| 60267 | ZAPATERO EGIPTO FUELLE 2 PUERTAS | | | | 110 | 307 | 338 | 384 |
| | 120 | 87 | 32 | 0,43 | 1 | 624 € | 687 € | 781 € |
| TOTAL ZAPATERO + ESPEJO | | | | | | 553 | 584 | 630 |
| | | | | | | 1.124 € | 1.187 € | 1.281 € |



18 PARES

| | ANCHO | ALTO | FONDO | VOL | PAG | MATE | FRENTE ALTO BRILLO | ALTO BRILLO |
|--|-------|------|-------|-----|-----|------|--------------------|-------------|
| | cm | | | m3 | UD | | | |

U21 - 152 MATE + 041 METALIZADO

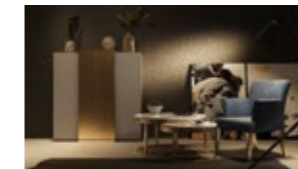

| | | | | | | | | |
|--------------|---------------------------|-----|----|------|----------|--------------|--------------|--------------|
| 60268 | ZAPATERO EGIPTO 2 PUERTAS | | | | 111 | 381 | 419 | 476 |
| | 120 | 137 | 32 | 0,66 | 1 | 775 € | 852 € | 968 € |

30 PARES

| | | | | | | | | |
|--------------|---------------|----|----|------|----------|--------------|--|--------------|
| 40806 | SILLA DEMETER | | | | 124 | 190 | | 219 |
| | 62 | 85 | 60 | 0,23 | 1 | 386 € | | 445 € |

| | | | | | | | | |
|--------------|------------------------------------|----|----|------|----------|----------------|--|--|
| 58489 | JUEGO MESAS CIRCULARES TAPA MARMOL | | | | 124 | 504 | | |
| | 80 | 45 | 80 | 0,36 | 1 | 1.025 € | | |

U22 - 150 MATE + 041 METALIZADO (APERTURA IZQUIERDA)



| | | | | | | | | |
|--------------|--------------------------|-----|----|------|----------|--------------|--------------|--------------|
| 60269 | ZAPATERO EGIPTO 1 PUERTA | | | | 111 | 271 | 298 | 339 |
| | 60 | 127 | 32 | 0,32 | 1 | 551 € | 606 € | 689 € |



15 PARES

U23 - 121 MATE + 041 METALIZADO



| | | | | | | | | |
|------------------|---------------------------|-----|----|------|----------|--------------|--------------|--------------|
| ZA0260261 | ZAPATERO FUELLE 2 PUERTAS | | | | 107 | 346 | 381 | 415 |
| | 120 | 100 | 29 | 0,45 | 1 | 703 € | 775 € | 844 € |
| 21062 | ESPEJO METALICO ESPIRAL | | | | 121 | 151 | | |
| | 100 | 100 | 5 | 0,11 | 1 | 307 € | | |

| | | | | | | | | |
|--------------------------------|--|--|--|--|--|----------------|----------------|----------------|
| TOTAL ZAPATERO + ESPEJO | | | | | | 497 | 532 | 566 |
| | | | | | | 1.010 € | 1.082 € | 1.151 € |



18 PARES

| | | | | | | | | |
|--------------|---|----|----|------|----------|--------------|--|--------------|
| 54411 | MESITA CIRCULO C/PIE METALICO CIRCULAR TAP MADERA | | | | 125 | 180 | | 225 |
| | 50 | 50 | 50 | 0,17 | 1 | 366 € | | 457 € |

| | | | | | | | | |
|--------------|-------------|----|----|------|----------|--------------|--|--------------|
| 48884 | SILLÓN ARES | | | | 124 | 186 | | 214 |
| | 73 | 85 | 55 | 0,42 | 1 | 378 € | | 435 € |

| | ANCHO | ALTO | FONDO | VOL | PAG | MATE | FRENTE ALTO BRILLO | ALTO BRILLO |
|--|-------|------|-------|-----|-----|------|--------------------|-------------|
| | cm | | | m3 | UD | | | |

U24 - 150 MATE + 040 METALIZADO



| | | | | | | | | |
|------------------|--------------------|-----|----|------|----------|--------------|--------------|----------------|
| ZA0260262 | ZAPATERO 2 PUERTAS | | | | 108 | 426 | 469 | 511 |
| | 120 | 150 | 29 | 0,66 | 1 | 866 € | 953 € | 1.039 € |



30 PARES

U25 - 123 MATE + 044 METALIZADO (APERTURA IZQUIERDA)



| | | | | | | | | |
|------------------|-------------------|-----|----|------|----------|--------------|--------------|--------------|
| ZA0260263 | ZAPATERO 1 PUERTA | | | | 108 | 323 | 355 | 388 |
| | 60 | 140 | 29 | 0,32 | 1 | 657 € | 722 € | 789 € |



15 PARES

U26 - 162 MATE + 040 METALIZADO



| | | | | | | | | |
|------------------|---------------------------------|-----|----|------|----------|--------------|--------------|--------------|
| 21054 | ESPEJO CIRCULAR MITAD METALICO | | | | 118 | 143 | | |
| | 100 | 100 | 10 | 0,17 | 1 | 291 € | | |
| ZA0460261 | ZAPATERO FUELLE 2 PUERTAS LISAS | | | | 109 | 278 | 306 | 334 |
| | 120 | 90 | 29 | 0,40 | 1 | 565 € | 622 € | 679 € |

| | | | | | | | | |
|--------------------------------|--|--|--|--|--|--------------|--------------|--------------|
| TOTAL ZAPATERO + ESPEJO | | | | | | 421 | 449 | 477 |
| | | | | | | 856 € | 913 € | 970 € |



18 PARES

| | | | | | | | | |
|--------------|----------|----|----|------|----------|--------------|--|--|
| 45355 | BANQUETA | | | | 122 | 170 | | |
| | 63 | 70 | 80 | 0,43 | 1 | 346 € | | |

| | | | | | | | | |
|--------------|---|----|----|------|----------|--------------|--|--------------|
| 54412 | MESITA OVALO C/PIE METALICO OVALADO T/MAD | | | | 125 | 180 | | 225 |
| | 60 | 50 | 30 | 0,13 | 1 | 366 € | | 457 € |

| | ANCHO | ALTO | FONDO | VOL | PAG | MATE | FRENTE ALTO BRILLO | ALTO BRILLO |
|--|-------|------|-------|-----|-----|------|--------------------|-------------|
| | cm | | | m3 | UD | | | |

U27 - 162 MATE + 184 MATE



| | | | | | | | | |
|--------------|---------------------------------|-----|----|------|----------|--------------|----------------|----------------|
| 45017 | ZAPATERO SERIK FUELLE 2 PUERTAS | | | | 104 | 458 | 504 | 573 |
| | 127 | 114 | 31 | 0,57 | 1 | 931 € | 1.025 € | 1.165 € |
| 21062 | ESPEJO METALICO ESPIRAL | | | | 121 | 151 | | |
| | 100 | 100 | 5 | 0,11 | 1 | 307 € | | |

| | | | | | | | | |
|--------------------------------|--|--|--|--|--|----------------|----------------|----------------|
| TOTAL ZAPATERO + ESPEJO | | | | | | 609 | 655 | 724 |
| | | | | | | 1.238 € | 1.332 € | 1.472 € |



18 PARES

| | | | | | | | | |
|--------------|---------------|----|----|------|----------|--------------|--|--|
| 45353 | BANQUETA EN U | | | | 122 | 174 | | |
| | 75 | 50 | 50 | 0,24 | 1 | 354 € | | |

U28 - 150 MATE + 041 METALIZADO



| | | | | | | | | |
|--------------|--------------------------|-----|----|------|----------|--------------|----------------|----------------|
| 45018 | ZAPATERO SERIK 2 PUERTAS | | | | 104 | 467 | 514 | 584 |
| | 127 | 154 | 31 | 0,76 | 1 | 949 € | 1.045 € | 1.187 € |



24 PARES

U29 - 120 MATE + 040 METALIZADO (APERTURA IZQUIERDA)



| | | | | | | | | |
|------------------|---------------------------------|-----|----|------|----------|--------------|--------------|--------------|
| 21015 | ESPEJO SEMIMETALICO MARCO CURVO | | | | 120 | 127 | | |
| | 50 | 135 | 5 | 0,08 | 1 | 258 € | | |
| ZA0460263 | ZAPATERO 1 PUERTA LISA | | | | 109 | 250 | 275 | 300 |
| | 60 | 130 | 29 | 0,30 | 1 | 508 € | 559 € | 610 € |

| | | | | | | | | |
|--------------------------------|--|--|--|--|--|--------------|--------------|--------------|
| TOTAL ZAPATERO + ESPEJO | | | | | | 377 | 402 | 427 |
| | | | | | | 766 € | 817 € | 868 € |



15 PARES

| | | | | | | | | |
|--------------|----------|----|----|------|----------|--------------|--|--|
| 45364 | BANQUETA | | | | 124 | 95 | | |
| | 50 | 50 | 50 | 0,17 | 1 | 193 € | | |

U30 - 141 MATE + 041 METALIZADO



| | | | | | | | | |
|------------------|--------------------------|-----|----|------|----------|--------------|--------------|--------------|
| ZA0460262 | ZAPATERO 2 PUERTAS LISAS | | | | 109 | 351 | 386 | 421 |
| | 120 | 140 | 29 | 0,62 | 1 | 714 € | 785 € | 856 € |



30 PARES

| | ANCHO | ALTO | FONDO | VOL | PAG | MATE | FRENTE ALTO BRILLO | ALTO BRILLO |
|--|-------|------|-------|-----|-----|------|--------------------|-------------|
| | cm | | | m3 | UD | | | |

U31 - 120 MATE + ROSETA CROMADA (CRISTAL FUME)



| | | | | | | | | |
|--------------------------------|---|-----|----|------|----------|--------------|----------------|----------------|
| 46020 | ESPEJO MARCO SERIK | | | | 117 | 116 | | 145 |
| | 100 | 100 | 4 | 0,10 | 1 | 236 € | | 295 € |
| 45588 | ZAPATERO SERIK II ROSETA FUELLE 2 PUERTAS | | | | 104 | 350 | 385 | 438 |
| | 120 | 94 | 31 | 0,45 | 1 | 712 € | 783 € | 890 € |
| TOTAL ZAPATERO + ESPEJO | | | | | | 466 | 501 | 583 |
| | | | | | | 947 € | 1.019 € | 1.185 € |



18 PARES

U32 - 120 MATE Y ROSETA CROMADA (CRISTAL FUME)



| | | | | | | | | |
|--------------|------------------------------------|-----|----|------|----------|--------------|--------------|--------------|
| 45589 | ZAPATERO SERIK II ROSETA 2 PUERTAS | | | | 104 | 374 | 411 | 468 |
| | 120 | 134 | 31 | 0,63 | 1 | 760 € | 836 € | 951 € |
| 45357 | BANQUETA | | | | 122 | 104 | | 125 |
| | 50 | 50 | 50 | 0,17 | 1 | 211 € | | 254 € |



24 PARES

U33 - 288 ALTO BRILLO + 041 METALIZADO



| | | | | | | | | |
|--------------------------------|------------------------------------|-----|-----|------|----------|----------------|----------------|----------------|
| ZA0160500 | ZAPATERO FUELLE 2 PUERTAS ACORDEÓN | | | | 113 | 340 | 374 | 408 |
| | 120 | 100 | 29 | 0,45 | 1 | 691 € | 760 € | 829 € |
| 21035 | JUEGO 3 ESPEJOS METALICOS PIEDRAS | | | | 121 | 246 | | |
| | | | 3,5 | | 1 | 500 € | | |
| TOTAL ZAPATERO + ESPEJO | | | | | | 586 | 620 | 654 |
| | | | | | | 1.191 € | 1.260 € | 1.330 € |



18 PARES

U34 - 146 MATE + 041 METALIZADO



| | | | | | | | | |
|------------------|-----------------------------|-----|----|------|----------|--------------|--------------|----------------|
| ZA0160501 | ZAPATERO 2 PUERTAS ACORDEÓN | | | | 113 | 415 | 457 | 498 |
| | 120 | 150 | 29 | 0,66 | 1 | 844 € | 929 € | 1.012 € |



30 PARES

| | ANCHO | ALTO | FONDO | VOL | PAG | MATE | FRENTE ALTO BRILLO | ALTO BRILLO |
|--|-------|------|-------|-----|-----|------|--------------------|-------------|
| | cm | | | m3 | UD | | | |

U35 - 162 MATE + 041 METALIZADO (APERTURA IZQUIERDA)



| | | | | | | | | |
|--------------------------------|----------------------------|-----|----|------|----------|--------------|--------------|--------------|
| 21030 | ESPEJO METALICO PLANETARIO | | | | 120 | 144 | | |
| | 60 | 60 | 3 | 0,03 | 1 | 293 € | | |
| ZA0160502 | ZAPATERO 1 PUERTA ACORDEÓN | | | | 113 | 276 | 304 | 331 |
| | 60 | 140 | 29 | 0,32 | 1 | 561 € | 618 € | 673 € |
| TOTAL ZAPATERO + ESPEJO | | | | | | 420 | 448 | 475 |
| | | | | | | 854 € | 911 € | 966 € |



15 PARES

U36 - 120 MATE (APERTURA IZQUIERDA)



| | | | | | | | | |
|--------------|--|-----|----|------|----------|--------------|--|--------------|
| 45587 | ZAPATERO COLUMNA SERIK 2 1 PUERTA ESPEJO | | | | 115 | 350 | | 438 |
| | 70 | 210 | 30 | 0,56 | 1 | 712 € | | 890 € |
| 45359 | SILLÓN | | | | 123 | 270 | | 307 |
| | 70 | 66 | 80 | 0,45 | 1 | 549 € | | 624 € |



21 PARES

U37 - 188 MATE (APERTURA IZQUIERDA)



| | | | | | | | | |
|--------------|---------------------------------------|-----|----|------|----------|--------------|--|--------------|
| 53000 | ZAPATERO COLUMNA KORA 1 PUERTA ESPEJO | | | | 116 | 350 | | 438 |
| | 70 | 210 | 30 | 0,56 | 1 | 712 € | | 890 € |
| 45357 | BANQUETA | | | | 122 | 104 | | 125 |
| | 50 | 50 | 50 | 0,17 | 1 | 211 € | | 254 € |



21 PARES

U38 - 120 MATE (APERTURA IZQUIERDA)



| | | | | | | | | |
|--------------|--|-----|----|------|----------|--------------|--|--------------|
| 58115 | ZAPATERO COLUMNA CURVE 1 PUERTA ESPEJO | | | | 116 | 350 | | 438 |
| | 70 | 210 | 30 | 0,56 | 1 | 712 € | | 890 € |
| 45358 | BANQUETA | | | | 123 | 140 | | |
| | 50 | 65 | 50 | 0,21 | 1 | 285 € | | |



21 PARES

| | ANCHO | ALTO | FONDO | VOL | PAG | MATE | FRENTE ALTO BRILLO | ALTO BRILLO |
|--|-------|------|-------|-----|-----|------|--------------------|-------------|
| | cm | | | m3 | UD | | | |

U39 - 120 MATE (APERTURA IZQUIERDA)

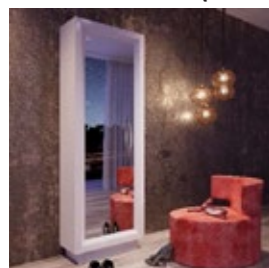

21 PARES

| | | | | | | | | |
|--------------|---------------------------------------|-----|----|------|----------|--------------|--|--------------|
| 48783 | ZAPATERO ENZO COLUMNA 1 PUERTA ESPEJO | | | | 116 | 350 | | 438 |
| | 70 | 210 | 30 | 0,56 | 1 | 712 € | | 890 € |
| 45355 | BANQUETA | | | | 122 | 170 | | |
| | 63 | 70 | 80 | 0,43 | 1 | 346 € | | |

U40 - 147 MATE + 041 METALIZADO

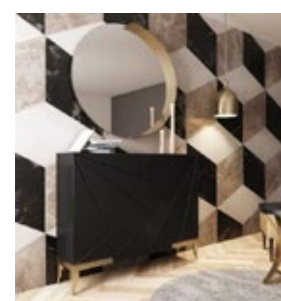

18 PARES

| | | | | | | | | |
|--------------------------------|--|-----|----|------|----------|----------------|----------------|----------------|
| 21054 | ESPEJO CIRCULAR MITAD METALICO | | | | 118 | 143 | | |
| | 100 | 100 | 10 | 0,17 | 1 | 291 € | | |
| 60272 | ZAPATERO FUELLE 2 PUERTAS RAYADO PICOS | | | | 111 | 385 | 424 | 462 |
| | 120 | 100 | 29 | 0,45 | 1 | 783 € | 862 € | 939 € |
| TOTAL ZAPATERO + ESPEJO | | | | | | 528 | 567 | 605 |
| | | | | | | 1.073 € | 1.153 € | 1.230 € |

U41 - 120 MATE + 043 METALIZADO



30 PARES

| | | | | | | | | |
|--------------|---------------------------------|-----|----|------|----------|--------------|----------------|----------------|
| 60273 | ZAPATERO 2 PUERTAS RAYADO PICOS | | | | 111 | 454 | 499 | 545 |
| | 120 | 150 | 29 | 0,66 | 1 | 923 € | 1.014 € | 1.108 € |
| 45363 | BANQUETA | | | | 123 | 110 | | 126 |
| | 70 | 50 | 45 | 0,21 | 1 | 224 € | | 256 € |

| | ANCHO | ALTO | FONDO | VOL | PAG | MATE | FRENTE ALTO BRILLO | ALTO BRILLO |
|--|-------|------|-------|-----|-----|------|--------------------|-------------|
| | cm | | | m3 | UD | | | |

U42 - 141 MATE + 043 METALIZADO (APERTURA IZQUIERDA)

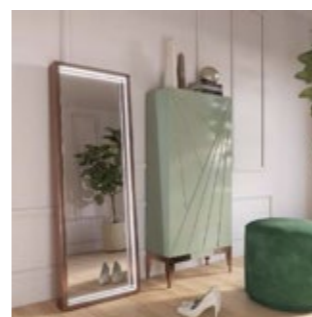

15 PARES

| | | | | | | | | |
|--------------------------------|--------------------------------|-----|----|------|----------|----------------|----------------|----------------|
| 60274 | ZAPATERO 1 PUERTA RAYADO PICOS | | | | 112 | 329 | 362 | 395 |
| | 60 | 140 | 29 | 0,32 | 1 | 669 € | 736 € | 803 € |
| 57711 | ESPEJO 150x70 cm AVANTY | | | | 121 | 122 | | 153 |
| | 70 | 150 | 10 | 0,17 | 1 | 248 € | | 311 € |
| RECARGO ILUMINACION LED | | | | | | | 84 | 84 |
| | | | | | | 1 | 171 € | 171 € |
| TOTAL ZAPATERO + ESPEJO | | | | | | 535 | 568 € | 632 € |
| | | | | | | 1.088 € | 1.155 € | 1.285 € |

U43 - 120 MATE + 041 METALIZADO



18 PARES

| | | | | | | | | |
|--------------------------------|----------------------------------|-----|----|------|----------|--------------|--------------|--------------|
| 21002 | ESPEJO METALICO ESQUINAS CURVAS | | | | 119 | 132 | | |
| | 100 | 100 | 10 | 0,17 | 1 | 268 € | | |
| 60401 | ZAPATERO FUELLE 2 PUERTAS DUELAS | | | | 112 | 293 | 322 | 352 |
| | 120 | 95 | 29 | 0,43 | 1 | 596 € | 655 € | 716 € |
| TOTAL ZAPATERO + ESPEJO | | | | | | 425 | 454 | 484 |
| | | | | | | 864 € | 923 € | 984 € |

U44 - 120 MATE + 040 METALIZADO (APERTURA IZQUIERDA)



15 PARES

| | | | | | | | | |
|--------------------------------|--------------------------|-----|----|------|----------|--------------|--------------|--------------|
| 21060 | ESPEJO METALICO ESPIRAL | | | | 121 | 140 | | |
| | 60 | 60 | 5 | 0,04 | 1 | 285 € | | |
| 60403 | ZAPATERO 1 PUERTA DUELAS | | | | 112 | 276 | 304 | 331 |
| | 60 | 135 | 29 | 0,31 | 1 | 561 € | 618 € | 673 € |
| TOTAL ZAPATERO + ESPEJO | | | | | | 416 | 444 | 471 |
| | | | | | | 846 € | 903 € | 958 € |
| 45364 | BANQUETA | | | | 124 | 95 | | |
| | 50 | 50 | 50 | 0,17 | 1 | 193 € | | |

| | ANCHO | ALTO | FONDO | VOL | PAG | MATE | FRENTE ALTO BRILLO | ALTO BRILLO |
|--|-------|------|-------|-----|-----|------|--------------------|-------------|
| | cm | | | m3 | UD | | | |

U45 - 152 MATE + 142 MATE + 040 METALIZADO



| | | | | | | | | |
|--------------|---------------------------|-----|----|------|----------|--------------|--------------|--------------|
| 60402 | ZAPATERO 2 PUERTAS DUELAS | | | | 112 | 376 | 414 | 451 |
| | 120 | 145 | 29 | 0,64 | 1 | 764 € | 842 € | 917 € |



30 PARES

U46 - 162 MATE + 041 METALIZADO



| | | | | | | | | |
|--------------|---------------------------------|-----|----|------|----------|--------------|--------------|--------------|
| 60600 | ZAPATERO FUELLE 2 PUERTAS ONDAS | | | | 114 | 311 | 342 | 373 |
| | 120 | 95 | 29 | 0,43 | 1 | 632 € | 695 € | 758 € |
| 21054 | ESPEJO CIRCULAR MITAD METALICO | | | | 118 | 143 | | |
| | 100 | 100 | 10 | 0,17 | 1 | 291 € | | |

| | | | | | | | | |
|--------------------------------|--|--|--|--|--|--------------|--------------|----------------|
| TOTAL ZAPATERO + ESPEJO | | | | | | 454 | 485 | 516 |
| | | | | | | 923 € | 986 € | 1.049 € |



18 PARES

U47 - 150 MATE + 040 METALIZADO (APERTURA IZQUIERDA)



| | | | | | | | | |
|--------------|-----------------------------|-----|----|------|----------|--------------|--------------|--------------|
| 60602 | ZAPATERO 1 PUERTA ONDAS | | | | 115 | 276 | 304 | 331 |
| | 60 | 135 | 29 | 0,31 | 1 | 561 € | 618 € | 673 € |
| 21049 | ESPEJO OVALADO SEMIMETALICO | | | | 119 | 160 | | |
| | 70 | 170 | 10 | 0,20 | 1 | 325 € | | |

| | | | | | | | | |
|--------------------------------|--|--|--|--|--|--------------|--------------|--------------|
| TOTAL ZAPATERO + ESPEJO | | | | | | 436 | 464 | 491 |
| | | | | | | 886 € | 943 € | 998 € |



15 PARES

U48 - 143 MATE + 041 METALIZADO



| | | | | | | | | |
|--------------|--------------------------|-----|----|------|----------|--------------|--------------|--------------|
| 60601 | ZAPATERO 2 PUERTAS ONDAS | | | | 114 | 366 | 403 | 439 |
| | 120 | 145 | 29 | 0,64 | 1 | 744 € | 819 € | 892 € |



30 PARES

| | ANCHO | ALTO | FONDO | VOL | PAG | MATE | FRENTE ALTO BRILLO | ALTO BRILLO |
|--|-------|------|-------|-----|-----|------|--------------------|-------------|
| | cm | | | m3 | UD | | | |

U49 - 162 MATE + 041 METALIZADO (APERTURA IZQUIERDA)



| | | | | | | | | |
|------------------|---------------------------------|-----|----|------|----------|--------------|--------------|--------------|
| ZA0260502 | ZAPATERO 1 PUERTA ACORDEÓN | | | | 114 | 276 | 304 | 331 |
| | 60 | 130 | 29 | 0,30 | 1 | 561 € | 618 € | 673 € |
| 21015 | ESPEJO SEMIMETALICO MARCO CURVO | | | | 120 | 127 | | |
| | 50 | 135 | 5 | 0,08 | 1 | 258 € | | |

| | | | | | | | | |
|--------------------------------|--|--|--|--|--|--------------|--------------|--------------|
| TOTAL ZAPATERO + ESPEJO | | | | | | 403 | 431 | 458 |
| | | | | | | 819 € | 876 € | 931 € |



15 PARES

U50 - 288 ALTO BRILLO + 041 METALIZADO



| | | | | | | | | |
|------------------|-----------------------------|-----|----|------|----------|--------------|--------------|--------------|
| ZA0260501 | ZAPATERO 2 PUERTAS ACORDEÓN | | | | 114 | 381 | 419 | 457 |
| | 120 | 140 | 29 | 0,62 | 1 | 775 € | 852 € | 929 € |



30 PARES

U51 - 120 MATE + 040 METALIZADO



| | | | | | | | | |
|------------------|------------------------------------|-----|----|------|----------|--------------|--------------|--------------|
| ZA0260500 | ZAPATERO FUELLE 2 PUERTAS ACORDEÓN | | | | 113 | 299 | 329 | 359 |
| | 120 | 90 | 29 | 0,40 | 1 | 608 € | 669 € | 730 € |
| 21032 | ESPEJO METALICO PLANETARIO | | | | 120 | 157 | | |
| | 100 | 100 | 3 | 0,09 | 1 | 319 € | | |

| | | | | | | | | |
|--------------------------------|--|--|--|--|--|--------------|--------------|----------------|
| TOTAL ZAPATERO + ESPEJO | | | | | | 456 | 486 | 516 |
| | | | | | | 927 € | 988 € | 1.049 € |

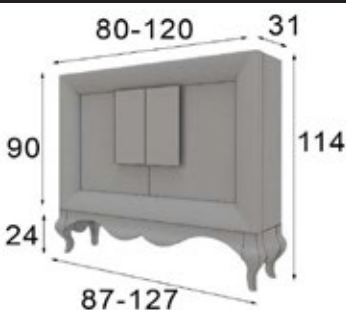

18 PARES

| | ANCHO | ALTO | FONDO | VOL | MATE | FRENTE ALTO BRILLO | ALTO BRILLO |
|---|--|------|-------|----------------|--------------|--------------------|----------------|
| | cm | | | m ³ | | | |
|  | 45017 ZAPATERO SERIK FUELLE 2 PUERTAS | | | | 458 | 504 | 573 |
| | 87-127 | 114 | 31 | | 931 € | 1.025 € | 1.165 € |

ANCHO DE 80 A 120 CM SIN INCREMENTO

RECARGO LAMINADO EN TIRADORES: 26 PUNTOS - 53 €
 RECARGO LAMINADO EN PUERTAS: 90 PUNTOS - 183 €
 RECARGO LAMINADO EN MOLDURA: 126 PUNTOS - 256 €
 RECARGO LAMINADO EN BASE ISABELINA: 71 PUNTOS - 144 €

18
PARES 

ANCHO 120 cm

OBLIGATORIO SUJETAR A LA PARED

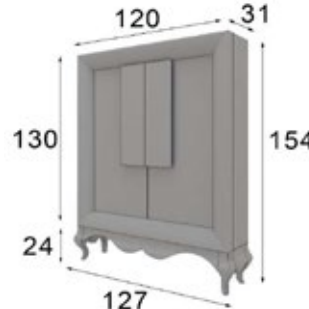
| | | | | | | | |
|---|---------------------------------------|-----|----|------|--------------|----------------|----------------|
|  | 45018 ZAPATERO SERIK 2 PUERTAS | | | | 467 | 514 | 584 |
| | 127 | 154 | 31 | 0,76 | 949 € | 1.045 € | 1.187 € |

RECARGO LAMINADO EN TIRADORES: 26 PUNTOS - 53 €
 RECARGO LAMINADO EN PUERTAS: 90 PUNTOS - 183 €
 RECARGO LAMINADO EN MOLDURA: 150 PUNTOS - 305 €
 RECARGO LAMINADO EN BASE ISABELINA: 71 PUNTOS - 144 €

24
PARES 

OBLIGATORIO SUJETAR A LA PARED

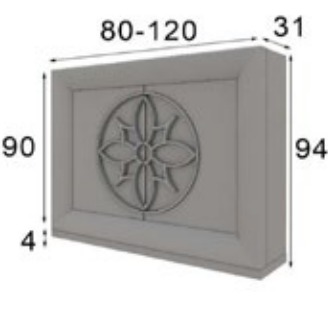
| | | | | | | | |
|--|--|----|----|--|--------------|--------------|--------------|
|  | 45588 ZAPATERO SERIK II ROSETA FUELLE 2 PUERTAS | | | | 350 | 385 | 438 |
| | 80-120 | 94 | 31 | | 712 € | 783 € | 890 € |

ANCHO DE 80 A 120 CM SIN INCREMENTO

ROSETA: ES POSIBLE EN ACABADOS MATES, ALTO BRILLO, METALIZADOS, CROMADA Y EFECTO CEMENTO
 RECARGO LAMINADO EN PUERTAS: 90 PUNTOS - 183 €
 RECARGO LAMINADO EN TRASERA DE ROSETA: 45 PUNTOS - 91 €

18
PARES 

ANCHO 120 cm

OBLIGATORIO SUJETAR A LA PARED

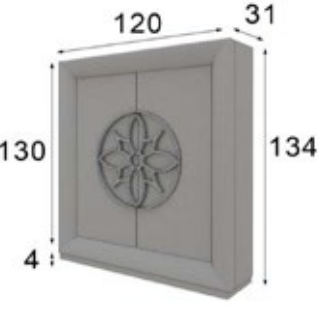
| | | | | | | | |
|---|---|-----|----|------|--------------|--------------|--------------|
|  | 45589 ZAPATERO SERIK II ROSETA 2 PUERTAS | | | | 374 | 411 | 468 |
| | 120 | 134 | 31 | 0,63 | 760 € | 836 € | 951 € |

ROSETA: ES POSIBLE EN ACABADOS MATES, ALTO BRILLO, METALIZADOS, CROMADA Y EFECTO CEMENTO

RECARGO LAMINADO EN PUERTAS: 90 PUNTOS - 183 €
 RECARGO LAMINADO EN TRASERA DE ROSETA: 45 PUNTOS - 91 €

24
PARES 

OBLIGATORIO SUJETAR A LA PARED

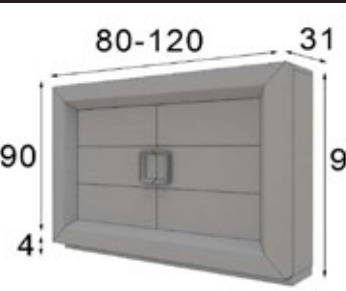
| | ANCHO | ALTO | FONDO | VOL | MATE | FRENTE ALTO BRILLO | ALTO BRILLO |
|---|--|------|-------|----------------|--------------|--------------------|--------------|
| | cm | | | m ³ | | | |
|  | 48781 ZAPATERO ENZO FUELLE 2 PUERTAS SIMULACION CAJONES | | | | 322 | 354 | 403 |
| | 80-120 | 94 | 31 | | 655 € | 720 € | 819 € |

ANCHO DE 80 A 120 CM SIN INCREMENTO

ACABADOS TIRADORES ENZO: PLATA VIEJA, ORO VIEJO, COBRE VIEJO O CROMO BRILLO
 RECARGO LAMINADO EN PUERTAS: 90 PUNTOS - 183 €

18
PARES 

ANCHO 120 cm

OBLIGATORIO SUJETAR A LA PARED

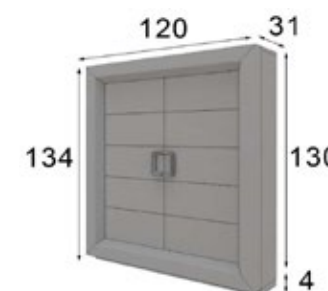
| | | | | | | | |
|---|---|-----|----|------|--------------|--------------|--------------|
|  | 48782 ZAPATERO ENZO 2 PUERTAS SIMULACION CAJONES | | | | 360 | 396 | 450 |
| | 120 | 135 | 31 | 0,63 | 732 € | 805 € | 915 € |

ACABADOS TIRADORES ENZO: PLATA VIEJA, ORO VIEJO, COBRE VIEJO O CROMO BRILLO
 RECARGO LAMINADO EN PUERTAS: 90 PUNTOS - 183 €

24
PARES 

OBLIGATORIO SUJETAR A LA PARED

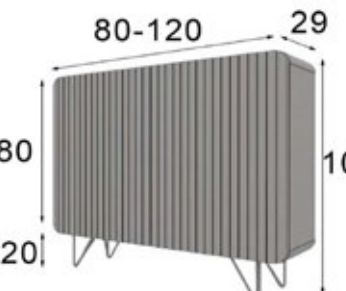
| | | | | | | | |
|--|--|-----|----|--|--------------|--------------|--------------|
|  | 54700 ZAPATERO KRYPSTAL FUELLE 2 PUERTAS DUELAS | | | | 343 | 377 | 429 |
| | 80-120 | 100 | 29 | | 697 € | 766 € | 872 € |

PATA METÁLICA: ES POSIBLE PINTARLAS EN GRUPO G-1 MATE Y EFECTO METALIZADOS

ANCHO DE 80 A 120 CM SIN INCREMENTO

18
PARES 

ANCHO 120 cm

OBLIGATORIO SUJETAR A LA PARED

| | | | | | | | |
|---|---|-----|----|------|--------------|--------------|--------------|
|  | 54701 ZAPATERO KRYPSTAL 2 PUERTAS DUELAS | | | | 383 | 421 | 479 |
| | 120 | 150 | 29 | 0,66 | 779 € | 856 € | 974 € |

PATA METÁLICA: ES POSIBLE PINTARLAS EN GRUPO G-1 MATE Y EFECTO METALIZADOS

OBLIGATORIO SUJETAR A LA PARED

30
PARES 

| | ANCHO | ALTO | FONDO | VOL | MATE | FRENTE ALTO BRILLO | ALTO BRILLO |
|---|----------------------------------|------|-------|----------------|--------------|--------------------|--------------|
| | cm | | | m ³ | | | |
|  | ZAPATERO KRYSYAL 1 PUERTA DUELAS | | | | 280 | 308 | 350 |
| | 60 | 140 | 29 | 0,32 | 569 € | 626 € | 712 € |

PATA METÁLICA: ES POSIBLE PINTARLAS EN GRUPO G-1 MATE Y EFECTO METALIZADOS

OBLIGATORIO SUJETAR A LA PARED

APERTURA A IZQUIERDA

15

PARES

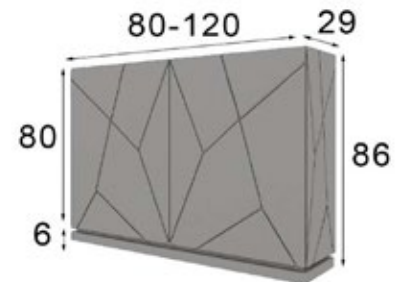

| | ANCHO | ALTO | FONDO | VOL | MATE | FRENTE ALTO BRILLO | ALTO BRILLO |
|--|----------------------------------|------|-------|----------------|--------------|--------------------|--------------|
| | cm | | | m ³ | | | |
|  | ZAPATERO FUELLE AVANTY 2 PUERTAS | | | | 346 | 381 | 433 |
| | 80-120 | 86 | 29 | | 703 € | 775 € | 880 € |

ANCHO DE 80 A 120 CM SIN INCREMENTO

OBLIGATORIO SUJETAR A LA PARED

LUZ LED EN ZÓCALO 52 PUNTOS

18

PARES

ANCHO 120 cm

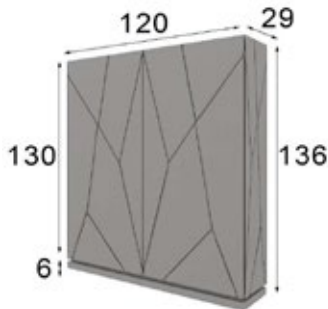

| | ANCHO | ALTO | FONDO | VOL | MATE | FRENTE ALTO BRILLO | ALTO BRILLO |
|--|---------------------------|------|-------|----------------|--------------|--------------------|----------------|
| | cm | | | m ³ | | | |
|  | ZAPATERO AVANTY 2 PUERTAS | | | | 402 | 442 | 503 |
| | 120 | 136 | 29 | 0,60 | 817 € | 899 € | 1.023 € |

OBLIGATORIO SUJETAR A LA PARED

LUZ LED EN ZÓCALO 52 PUNTOS

30

PARES

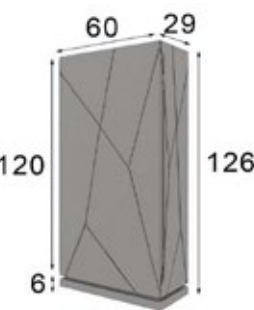

| | ANCHO | ALTO | FONDO | VOL | MATE | FRENTE ALTO BRILLO | ALTO BRILLO |
|---|--------------------------|------|-------|----------------|--------------|--------------------|--------------|
| | cm | | | m ³ | | | |
|  | ZAPATERO AVANTY 1 PUERTA | | | | 255 | 281 | 319 |
| | 60 | 126 | 29 | 0,29 | 518 € | 571 € | 649 € |

OBLIGATORIO SUJETAR A LA PARED

LUZ LED EN ZÓCALO 48 PUNTOS

APERTURA A IZQUIERDA

15

PARES



| | ANCHO | ALTO | FONDO | VOL | MATE | FRENTE ALTO BRILLO | ALTO BRILLO |
|---|---------------------------------------|------|-------|----------------|--------------|--------------------|----------------|
| | cm | | | m ³ | | | |
|  | ZAPATERO VIENA FUELLE 2 PUERTAS LISAS | | | | 411 | 452 | 493 |
| | 80-120 | 100 | 29 | | 836 € | 919 € | 1.002 € |

PATAS METÁlicas: ES POSIBLE PINTARLAS EN ACABADOS MATES Y METALIZADOS

TIRADORES: ES POSIBLE PINTARLOS EN ACABADOS MATES Y EFECTO METALIZADO

ANCHO DE 80 A 120 CM SIN INCREMENTO

OBLIGATORIO SUJETAR A LA PARED

18

PARES

ANCHO 120 cm



| | ANCHO | ALTO | FONDO | VOL | MATE | FRENTE ALTO BRILLO | ALTO BRILLO |
|---|--------------------------------|------|-------|----------------|----------------|--------------------|----------------|
| | cm | | | m ³ | | | |
|  | ZAPATERO VIENA 2 PUERTAS LISAS | | | | 499 | 549 | 599 |
| | 120 | 150 | 29 | 0,66 | 1.014 € | 1.116 € | 1.218 € |

PATAS METÁlicas: ES POSIBLE PINTARLAS EN ACABADOS MATES Y METALIZADOS

TIRADORES: ES POSIBLE PINTARLOS EN ACABADOS MATES Y EFECTO METALIZADO

OBLIGATORIO SUJETAR A LA PARED

30

PARES

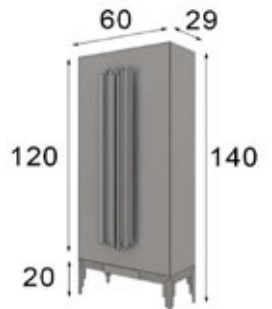

| | ANCHO | ALTO | FONDO | VOL | MATE | FRENTE ALTO BRILLO | ALTO BRILLO |
|--|-------------------------------|------|-------|----------------|--------------|--------------------|--------------|
| | cm | | | m ³ | | | |
|  | ZAPATERO VIENA 1 PUERTA LISAS | | | | 385 | 424 | 462 |
| | 60 | 140 | 29 | 0,32 | 783 € | 862 € | 939 € |

PATAS METÁlicas: ES POSIBLE PINTARLAS EN ACABADOS MATES Y METALIZADOS

TIRADORES: ES POSIBLE PINTARLOS EN ACABADOS MATES Y EFECTO METALIZADO

APERTURA A IZQUIERDA

OBLIGATORIO SUJETAR A LA PARED

15

PARES



| | ANCHO | ALTO | FONDO | VOL | MATE | FRENTE ALTO BRILLO | ALTO BRILLO |
|---|---------------------------|------|-------|----------------|--------------|--------------------|--------------|
| | cm | | | m ³ | | | |
|  | ZAPATERO FUELLE 2 PUERTAS | | | | 346 | 381 | 415 |
| | 80-120 | 100 | 29 | | 703 € | 775 € | 844 € |

PATAS METÁlicas: ES POSIBLE PINTARLAS EN ACABADOS MATES Y METALIZADOS

TIRADORES: ES POSIBLE PINTARLOS EN ACABADOS MATES Y EFECTO METALIZADO

ANCHO DE 80 A 120 CM SIN INCREMENTO

OBLIGATORIO SUJETAR A LA PARED

18

PARES

ANCHO 120 cm



| | ANCHO | ALTO | FONDO | VOL | MATE | FRENTE ALTO BRILLO | ALTO BRILLO |
|---|--------------------|------|-------|----------------|--------------|--------------------|----------------|
| | cm | | | m ³ | | | |
|  | ZAPATERO 2 PUERTAS | | | | 426 | 469 | 511 |
| | 120 | 150 | 29 | 0,66 | 866 € | 953 € | 1.039 € |

PATAS METÁLICAS: ES POSIBLE PINTARLAS EN ACABADOS MATES Y METALIZADOS
TIRADORES: ES POSIBLE PINTARLOS EN ACABADOS MATES Y EFECTO METALIZADO

OBLIGATORIO SUJETAR A LA PARED

30
PARES 

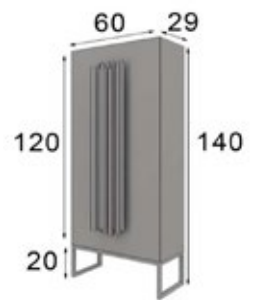
| | ANCHO | ALTO | FONDO | VOL | MATE | FRENTE ALTO BRILLO | ALTO BRILLO |
|---|-------------------|------|-------|----------------|--------------|--------------------|--------------|
| | cm | | | m ³ | | | |
|  | ZAPATERO 1 PUERTA | | | | 323 | 355 | 388 |
| | 60 | 140 | 29 | 0,32 | 657 € | 722 € | 789 € |

PATAS METÁLICAS: ES POSIBLE PINTARLAS EN ACABADOS MATES Y METALIZADOS
TIRADORES: ES POSIBLE PINTARLOS EN ACABADOS MATES Y EFECTO METALIZADO

APERTURA A IZQUIERDA

OBLIGATORIO SUJETAR A LA PARED

15
PARES 

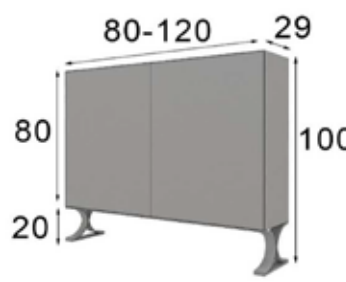
| | ANCHO | ALTO | FONDO | VOL | MATE | FRENTE ALTO BRILLO | ALTO BRILLO |
|--|---------------------------------|------|-------|----------------|--------------|--------------------|--------------|
| | cm | | | m ³ | | | |
|  | ZAPATERO FUELLE 2 PUERTAS LISAS | | | | 333 | 366 | 400 |
| | 80-120 | 100 | 29 | | 677 € | 744 € | 813 € |

PATA METÁLICA: ES POSIBLE PINTARLAS EN GRUPO G-1 MATE Y EFECTO METALIZADOS

ANCHO DE 80 A 120 CM SIN INCREMENTO

OBLIGATORIO SUJETAR A LA PARED

18
PARES 

ANCHO 120 cm

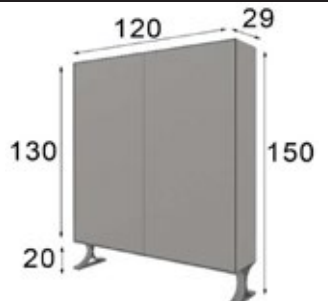
| | ANCHO | ALTO | FONDO | VOL | MATE | FRENTE ALTO BRILLO | ALTO BRILLO |
|---|--------------------------|------|-------|----------------|--------------|--------------------|--------------|
| | cm | | | m ³ | | | |
|  | ZAPATERO 2 PUERTAS LISAS | | | | 397 | 437 | 476 |
| | 120 | 150 | 29 | 0,66 | 807 € | 888 € | 968 € |

PATA METÁLICA: ES POSIBLE PINTARLAS EN GRUPO G-1 MATE Y EFECTO METALIZADOS

OBLIGATORIO SUJETAR A LA PARED

30
PARES 

| | ANCHO | ALTO | FONDO | VOL | MATE | FRENTE ALTO BRILLO | ALTO BRILLO |
|---|------------------------|------|-------|----------------|--------------|--------------------|--------------|
| | cm | | | m ³ | | | |
|  | ZAPATERO 1 PUERTA LISA | | | | 296 | 326 | 355 |
| | 60 | 140 | 29 | 0,32 | 602 € | 663 € | 722 € |

PATA METÁLICA: ES POSIBLE PINTARLAS EN GRUPO G-1 MATE Y EFECTO METALIZADOS

OBLIGATORIO SUJETAR A LA PARED

APERTURA A IZQUIERDA

15
PARES 

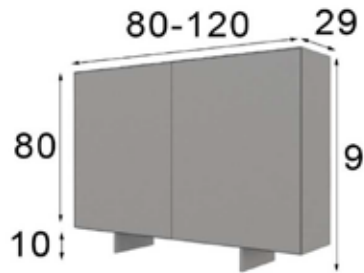
| | ANCHO | ALTO | FONDO | VOL | MATE | FRENTE ALTO BRILLO | ALTO BRILLO |
|---|---------------------------------|------|-------|----------------|--------------|--------------------|--------------|
| | cm | | | m ³ | | | |
|  | ZAPATERO FUELLE 2 PUERTAS LISAS | | | | 278 | 306 | 334 |
| | 80-120 | 90 | 29 | | 565 € | 622 € | 679 € |

ANCHO DE 80 A 120 CM SIN INCREMENTO

PATA METÁLICA: ES POSIBLE PINTARLAS EN GRUPO G-1 MATE Y EFECTO METALIZADOS

OBLIGATORIO SUJETAR A LA PARED

18
PARES 

ANCHO 120 cm

| | ANCHO | ALTO | FONDO | VOL | MATE | FRENTE ALTO BRILLO | ALTO BRILLO |
|--|--------------------------|------|-------|----------------|--------------|--------------------|--------------|
| | cm | | | m ³ | | | |
|  | ZAPATERO 2 PUERTAS LISAS | | | | 351 | 386 | 421 |
| | 120 | 140 | 29 | 0,62 | 714 € | 785 € | 856 € |

PATA METÁLICA: ES POSIBLE PINTARLAS EN GRUPO G-1 MATE Y EFECTO METALIZADOS

OBLIGATORIO SUJETAR A LA PARED

30
PARES 

| | ANCHO | ALTO | FONDO | VOL | MATE | FRENTE ALTO BRILLO | ALTO BRILLO |
|---|------------------------|------|-------|----------------|--------------|--------------------|--------------|
| | cm | | | m ³ | | | |
|  | ZAPATERO 1 PUERTA LISA | | | | 250 | 275 | 300 |
| | 60 | 130 | 29 | 0,30 | 508 € | 559 € | 610 € |

PATA METÁLICA: ES POSIBLE PINTARLAS EN GRUPO G-1 MATE Y EFECTO METALIZADOS

OBLIGATORIO SUJETAR A LA PARED

APERTURA A IZQUIERDA

15
PARES 

| | ANCHO | ALTO | FONDO | VOL | MATE | FRENTE ALTO BRILLO | ALTO BRILLO |
|--|-------|------|-------|----------------|------|--------------------|-------------|
| | cm | | | m ³ | | | |

| | | | | | | | |
|--|--------------|---------------------------------|-----|----|--------------|--------------|--------------|
|  | 60264 | ZAPATERO FUELLE 2 PUERTAS LISAS | | | 336 | 370 | 403 |
| | | 84-124 | 104 | 33 | 683 € | 752 € | 819 € |

PATA METÁLICA: ES POSIBLE PINTARLAS EN GRUPO G-1 MATE Y EFECTO METALIZADOS
 ANCHO DE 80 A 120 CM SIN INCREMENTO
 OBLIGATORIO SUJETAR A LA PARED

18
 PARES 
 ANCHO 120 cm

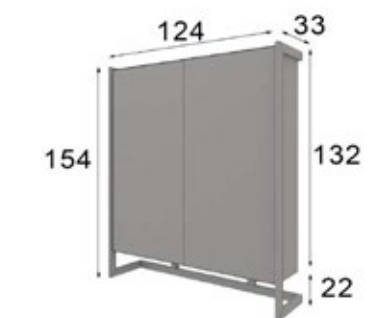
| | | | | | | | |
|--|--------------|--------------------------|-----|----|--------------|--------------|--------------|
|  | 60265 | ZAPATERO 2 PUERTAS LISAS | | | 404 | 444 | 485 |
| | | 124 | 154 | 33 | 821 € | 903 € | 986 € |

PATA METÁLICA: ES POSIBLE PINTARLAS EN GRUPO G-1 MATE Y EFECTO METALIZADOS
 OBLIGATORIO SUJETAR A LA PARED

30
 PARES 

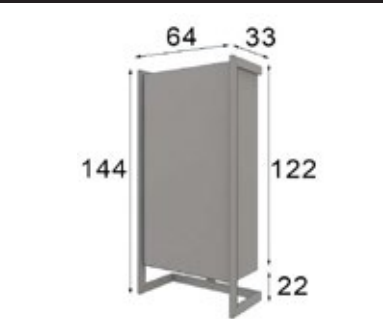
| | | | | | | | |
|---|--------------|-------------------------|-----|----|--------------|--------------|--------------|
|  | 60266 | ZAPATERO 1 PUERTA LISAS | | | 299 | 329 | 359 |
| | | 64 | 144 | 33 | 608 € | 669 € | 730 € |

PATA METÁLICA: ES POSIBLE PINTARLAS EN GRUPO G-1 MATE Y EFECTO METALIZADOS
 OBLIGATORIO SUJETAR A LA PARED
 APERTURA A IZQUIERDA

15
 PARES 

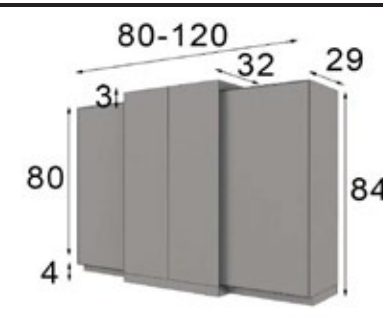
| | | | | | | | |
|--|--------------|----------------------------------|----|----|--------------|--------------|--------------|
|  | 60267 | ZAPATERO EGIPTO FUELLE 2 PUERTAS | | | 307 | 338 | 384 |
| | | 80-120 | 87 | 32 | 624 € | 687 € | 781 € |

ANCHO DE 80 A 120 CM SIN INCREMENTO
 OBLIGATORIO SUJETAR A LA PARED
 RECARGO LAMINADO EN TIRADORES: 100 PUNTOS - 203 €

18
 PARES 
 ANCHO 120 cm

| | ANCHO | ALTO | FONDO | VOL | MATE | FRENTE ALTO BRILLO | ALTO BRILLO |
|--|-------|------|-------|----------------|------|--------------------|-------------|
| | cm | | | m ³ | | | |

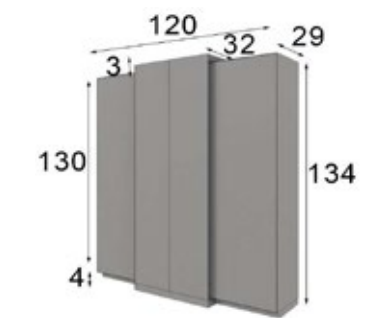
| | | | | | | | |
|---|--------------|---------------------------|-----|----|--------------|--------------|--------------|
|  | 60268 | ZAPATERO EGIPTO 2 PUERTAS | | | 381 | 419 | 476 |
| | | 120 | 137 | 32 | 775 € | 852 € | 968 € |

OBLIGATORIO SUJETAR A LA PARED
 RECARGO LAMINADO EN TIRADORES: 100 PUNTOS - 203 €

30
 PARES 

| | | | | | | | |
|---|--------------|--------------------------|-----|----|--------------|--------------|--------------|
|  | 60269 | ZAPATERO EGIPTO 1 PUERTA | | | 271 | 298 | 339 |
| | | 60 | 127 | 32 | 551 € | 606 € | 689 € |

OBLIGATORIO SUJETAR A LA PARED
 RECARGO LAMINADO EN TIRADORES: 60 PUNTOS - 122 €
 APERTURA A IZQUIERDA

15
 PARES 

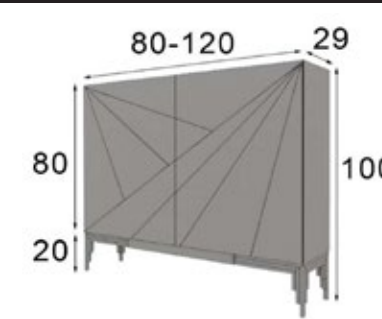
| | | | | | | | |
|--|--------------|--|-----|----|--------------|--------------|--------------|
|  | 60272 | ZAPATERO FUELLE 2 PUERTAS RAYADO PICOS | | | 385 | 424 | 462 |
| | | 80-120 | 100 | 29 | 783 € | 862 € | 939 € |

ANCHO DE 80 A 120 CM SIN INCREMENTO
 PATA METÁLICA: ES POSIBLE PINTARLAS EN GRUPO G-1 MATE Y EFECTO METALIZADOS
 OBLIGATORIO SUJETAR A LA PARED

18
 PARES 
 ANCHO 120 cm

| | | | | | | | |
|---|--------------|---------------------------------|-----|----|--------------|----------------|----------------|
|  | 60273 | ZAPATERO 2 PUERTAS RAYADO PICOS | | | 454 | 499 | 545 |
| | | 120 | 150 | 29 | 923 € | 1.014 € | 1.108 € |

PATA METÁLICA: ES POSIBLE PINTARLAS EN GRUPO G-1 MATE Y EFECTO METALIZADOS
 OBLIGATORIO SUJETAR A LA PARED

30
 PARES 

| | ANCHO | ALTO | FONDO | VOL | MATE | FRENTE ALTO BRILLO | ALTO BRILLO |
|---|---|------|-------|----------------|--------------|--------------------|--------------|
| | cm | | | m ³ | | | |
|  | 60274 ZAPATERO 1 PUERTA RAYADO PICOS | | | | 329 | 362 | 395 |
| | 60 | 140 | 29 | 0,32 | 669 € | 736 € | 803 € |

PATA METÁLICA: ES POSIBLE PINTARLAS EN GRUPO G-1 MATE Y EFECTO METALIZADOS

OBLIGATORIO SUJETAR A LA PARED

APERTURA A IZQUIERDA

15

PARES

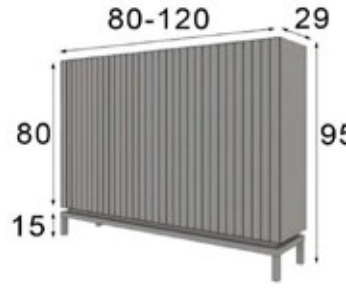

| | ANCHO | ALTO | FONDO | VOL | MATE | FRENTE ALTO BRILLO | ALTO BRILLO |
|---|---|------|-------|----------------|--------------|--------------------|--------------|
| | cm | | | m ³ | | | |
|  | 60401 ZAPATERO FUELLE 2 PUERTAS DUELAS | | | | 293 | 322 | 352 |
| | 80-120 | 95 | 29 | | 596 € | 655 € | 716 € |

ANCHO DE 80 A 120 CM SIN INCREMENTO

PATA METÁLICA: ES POSIBLE PINTARLAS EN GRUPO G-1 MATE Y EFECTO METALIZADOS

OBLIGATORIO SUJETAR A LA PARED

18

PARES

ANCHO 120 cm



| | ANCHO | ALTO | FONDO | VOL | MATE | FRENTE ALTO BRILLO | ALTO BRILLO |
|--|--|------|-------|----------------|--------------|--------------------|--------------|
| | cm | | | m ³ | | | |
|  | 60402 ZAPATERO 2 PUERTAS DUELAS | | | | 376 | 414 | 451 |
| | 120 | 145 | 29 | 0,64 | 764 € | 842 € | 917 € |

PATA METÁLICA: ES POSIBLE PINTARLAS EN GRUPO G-1 MATE Y EFECTO METALIZADOS

OBLIGATORIO SUJETAR A LA PARED

30

PARES

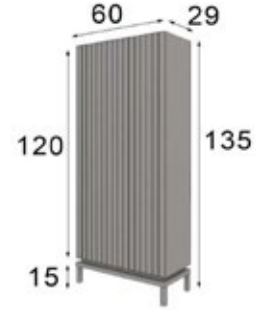

| | ANCHO | ALTO | FONDO | VOL | MATE | FRENTE ALTO BRILLO | ALTO BRILLO |
|---|---------------------------------------|------|-------|----------------|--------------|--------------------|--------------|
| | cm | | | m ³ | | | |
|  | 60403 ZAPATERO 1 PUERTA DUELAS | | | | 276 | 304 | 331 |
| | 60 | 135 | 29 | 0,31 | 561 € | 618 € | 673 € |

PATA METÁLICA: ES POSIBLE PINTARLAS EN GRUPO G-1 MATE Y EFECTO METALIZADOS

OBLIGATORIO SUJETAR A LA PARED

APERTURA A IZQUIERDA

15

PARES



| | ANCHO | ALTO | FONDO | VOL | MATE | FRENTE ALTO BRILLO | ALTO BRILLO |
|---|---|------|-------|----------------|--------------|--------------------|--------------|
| | cm | | | m ³ | | | |
|  | ZA0160500 ZAPATERO FUELLE 2 PUERTAS ACORDEÓN | | | | 340 | 374 | 408 |
| | 80-120 | 100 | 29 | | 691 € | 760 € | 829 € |

ANCHO DE 80 A 120 CM SIN INCREMENTO

PATA METÁLICA: ES POSIBLE PINTARLAS EN GRUPO G-1 MATE Y EFECTO METALIZADOS

OBLIGATORIO SUJETAR A LA PARED

18

PARES



ANCHO 120 cm

| | ANCHO | ALTO | FONDO | VOL | MATE | FRENTE ALTO BRILLO | ALTO BRILLO |
|---|--|------|-------|----------------|--------------|--------------------|----------------|
| | cm | | | m ³ | | | |
|  | ZA0160501 ZAPATERO 2 PUERTAS ACORDEÓN | | | | 415 | 457 | 498 |
| | 120 | 150 | 29 | 0,66 | 844 € | 929 € | 1.012 € |

PATA METÁLICA: ES POSIBLE PINTARLAS EN GRUPO G-1 MATE Y EFECTO METALIZADOS

OBLIGATORIO SUJETAR A LA PARED

30

PARES

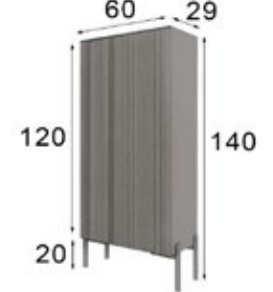

| | ANCHO | ALTO | FONDO | VOL | MATE | FRENTE ALTO BRILLO | ALTO BRILLO |
|--|---|------|-------|----------------|--------------|--------------------|--------------|
| | cm | | | m ³ | | | |
|  | ZA0160502 ZAPATERO 1 PUERTA ACORDEÓN | | | | 276 | 304 | 331 |
| | 60 | 140 | 29 | 0,32 | 561 € | 618 € | 673 € |

PATA METÁLICA: ES POSIBLE PINTARLAS EN GRUPO G-1 MATE Y EFECTO METALIZADOS

OBLIGATORIO SUJETAR A LA PARED

APERTURA A IZQUIERDA

15

PARES



| | ANCHO | ALTO | FONDO | VOL | MATE | FRENTE ALTO BRILLO | ALTO BRILLO |
|---|---|------|-------|----------------|--------------|--------------------|--------------|
| | cm | | | m ³ | | | |
|  | ZA0260500 ZAPATERO FUELLE 2 PUERTAS ACORDEÓN | | | | 299 | 329 | 359 |
| | 80-120 | 90 | 29 | | 608 € | 669 € | 730 € |

ANCHO DE 80 A 120 CM SIN INCREMENTO

PATA METÁLICA: ES POSIBLE PINTARLAS EN GRUPO G-1 MATE Y EFECTO METALIZADOS

OBLIGATORIO SUJETAR A LA PARED

18

PARES



ANCHO 120 cm

| | ANCHO | ALTO | FONDO | VOL | MATE | FRENTE ALTO BRILLO | ALTO BRILLO |
|---|--|------|-------|----------------|--------------|--------------------|--------------|
| | cm | | | m ³ | | | |
|  | ZA0260501 ZAPATERO 2 PUERTAS ACORDEÓN | | | | 381 | 419 | 457 |
| | 120 | 140 | 29 | 0,62 | 775 € | 852 € | 929 € |

PATA METÁLICA: ES POSIBLE PINTARLAS EN GRUPO G-1 MATE Y EFECTO METALIZADOS

OBLIGATORIO SUJETAR A LA PARED

30
PARES 

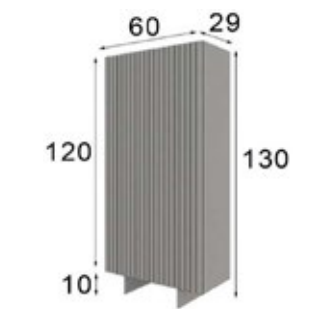
| | ANCHO | ALTO | FONDO | VOL | MATE | FRENTE ALTO BRILLO | ALTO BRILLO |
|---|---|------|-------|----------------|--------------|--------------------|--------------|
| | cm | | | m ³ | | | |
|  | ZA0260502 ZAPATERO 1 PUERTA ACORDEÓN | | | | 276 | 304 | 331 |
| | 60 | 130 | 29 | 0,30 | 561 € | 618 € | 673 € |

PATA METÁLICA: ES POSIBLE PINTARLAS EN GRUPO G-1 MATE Y EFECTO METALIZADOS

OBLIGATORIO SUJETAR A LA PARED

APERTURA A IZQUIERDA

15
PARES 

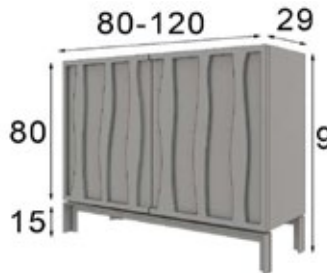
| | ANCHO | ALTO | FONDO | VOL | MATE | FRENTE ALTO BRILLO | ALTO BRILLO |
|--|--|------|-------|----------------|--------------|--------------------|--------------|
| | cm | | | m ³ | | | |
|  | 60600 ZAPATERO FUELLE 2 PUERTAS ONDAS | | | | 311 | 342 | 373 |
| | 80-120 | 95 | 29 | | 632 € | 695 € | 758 € |

ANCHO DE 80 A 120 CM SIN INCREMENTO

PATA METÁLICA: ES POSIBLE PINTARLAS EN GRUPO G-1 MATE Y EFECTO METALIZADOS

OBLIGATORIO SUJETAR A LA PARED

18
PARES 
ANCHO 120 cm

| | ANCHO | ALTO | FONDO | VOL | MATE | FRENTE ALTO BRILLO | ALTO BRILLO |
|---|---------------------------------------|------|-------|----------------|--------------|--------------------|--------------|
| | cm | | | m ³ | | | |
|  | 60601 ZAPATERO 2 PUERTAS ONDAS | | | | 366 | 403 | 439 |
| | 120 | 145 | 29 | 0,64 | 744 € | 819 € | 892 € |

PATA METÁLICA: ES POSIBLE PINTARLAS EN GRUPO G-1 MATE Y EFECTO METALIZADOS

OBLIGATORIO SUJETAR A LA PARED

30
PARES 

| | ANCHO | ALTO | FONDO | VOL | MATE | FRENTE ALTO BRILLO | ALTO BRILLO |
|---|--------------------------------------|------|-------|----------------|--------------|--------------------|--------------|
| | cm | | | m ³ | | | |
|  | 60602 ZAPATERO 1 PUERTA ONDAS | | | | 276 | 304 | 331 |
| | 60 | 135 | 29 | 0,31 | 561 € | 618 € | 673 € |

PATA METÁLICA: ES POSIBLE PINTARLAS EN GRUPO G-1 MATE Y EFECTO METALIZADOS

OBLIGATORIO SUJETAR A LA PARED

APERTURA A IZQUIERDA

15
PARES 

| | ANCHO | ALTO | FONDO | VOL | MATE | FRENTE ALTO BRILLO | ALTO BRILLO |
|---|---|------|-------|----------------|--------------|--------------------|--------------|
| | cm | | | m ³ | | | |
|  | 61000 ZAPATERO FUELLE 2 PUERTAS DESTELLO | | | | 348 | 383 | 418 |
| | 80-120 | 100 | 29 | | 707 € | 779 € | 850 € |

PATA METÁLICA: ES POSIBLE PINTARLAS EN GRUPO G-1 MATE Y EFECTO METALIZADOS

ANCHO DE 80 A 120 CM SIN INCREMENTO

OBLIGATORIO SUJETAR A LA PARED

18
PARES 
ANCHO 120 cm

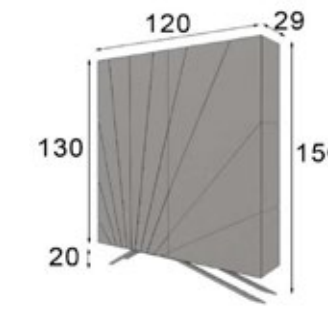
| | ANCHO | ALTO | FONDO | VOL | MATE | FRENTE ALTO BRILLO | ALTO BRILLO |
|--|--|------|-------|----------------|--------------|--------------------|--------------|
| | cm | | | m ³ | | | |
|  | 61001 ZAPATERO 2 PUERTAS DESTELLO | | | | 395 | 435 | 474 |
| | 120 | 150 | 29 | 0,66 | 803 € | 884 € | 964 € |

PATA METÁLICA: ES POSIBLE PINTARLAS EN GRUPO G-1 MATE Y EFECTO METALIZADOS

OBLIGATORIO SUJETAR A LA PARED

30
PARES 

| | ANCHO | ALTO | FONDO | VOL | MATE | FRENTE ALTO BRILLO | ALTO BRILLO |
|---|---|------|-------|----------------|--------------|--------------------|--------------|
| | cm | | | m ³ | | | |
|  | 45587 ZAPATERO COLUMNA SERIK 2 1 PUERTA ESPEJO | | | | 350 | | 438 |
| | 70 | 210 | 30 | 0,56 | 712 € | | 890 € |

TIRADOR SERIK 2 EN ACABADOS CROMO BRILLO U ORO MATE

RECARGO LAMINADO EN MOLDURA: 162 PUNTOS - 329 €

OBLIGATORIO SUJETAR A LA PARED

APERTURA A IZQUIERDA

21
PARES 

| | ANCHO | ALTO | FONDO | VOL | MATE | FRENTE ALTO BRILLO | ALTO BRILLO |
|---|---|------|-------|----------------|--------------|--------------------|--------------|
| | cm | | | m ³ | | | |
|  | 58115 ZAPATERO COLUMNA CURVE 1 PUERTA ESPEJO | | | | 350 | | 438 |
| | 70 | 210 | 30 | 0,56 | 712 € | | 890 € |

TIRADOR SERIK 2 EN ACABADOS CROMO BRILLO U ORO MATE

RECARGO LAMINADO EN MOLDURA: 162 PUNTOS - 329 €

OBLIGATORIO SUJETAR A LA PARED

APERTURA A IZQUIERDA

21
PARES 

| | ANCHO | ALTO | FONDO | VOL | MATE | FRENTE ALTO BRILLO | ALTO BRILLO |
|---|--|------|-------|----------------|--------------|--------------------|--------------|
| | cm | | | m ³ | | | |
|  | 53000 ZAPATERO COLUMNA KORA 1 PUERTA ESPEJO | | | | 350 | | 438 |
| | 70 | 210 | 30 | 0,56 | 712 € | | 890 € |

TIRADOR SERIK 2 EN ACABADOS CROMO BRILLO U ORO MATE

RECARGO LAMINADO EN MOLDURA: 162 PUNTOS - 329 €

OBLIGATORIO SUJETAR A LA PARED

APERTURA A IZQUIERDA

21
PARES 

| | ANCHO | ALTO | FONDO | VOL | MATE | FRENTE ALTO BRILLO | ALTO BRILLO |
|--|--|------|-------|----------------|--------------|--------------------|--------------|
| | cm | | | m ³ | | | |
|  | 48783 ZAPATERO ENZO COLUMNA 1 PUERTA ESPEJO | | | | 350 | | 438 |
| | 70 | 210 | 30 | 0,56 | 712 € | | 890 € |

TIRADOR SERIK 2 EN ACABADOS CROMO BRILLO U ORO MATE

RECARGO LAMINADO EN MOLDURA: 162 PUNTOS - 329 €

OBLIGATORIO SUJETAR A LA PARED

APERTURA A IZQUIERDA

21
PARES 

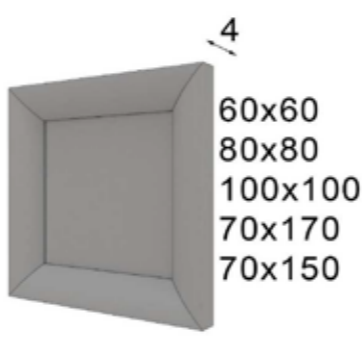
| | ANCHO | ALTO | FONDO | VOL | MATE | FRENTE ALTO BRILLO | ALTO BRILLO |
|---|---------------------------------|------|-------|----------------|--------------|--------------------|--------------|
| | cm | | | m ³ | | | |
|  | 46019 ESPEJO MARCO SERIK | | | | 75 | | 94 |
| | 60 | 60 | 4 | 0,04 | 152 € | | 191 € |
| | 46023 ESPEJO MARCO SERIK | | | | 93 | | 116 |
| | 80 | 80 | 4 | 0,07 | 189 € | | 236 € |
| | 46020 ESPEJO MARCO SERIK | | | | 116 | | 145 |
| | 100 | 100 | 4 | 0,10 | 236 € | | 295 € |
| | 46021 ESPEJO MARCO SERIK | | | | 128 | | 160 |
| | 70 | 150 | 4 | 0,10 | 260 € | | 325 € |
| | 46022 ESPEJO MARCO SERIK | | | | 134 | | 168 |
| | 70 | 170 | 4 | 0,12 | 272 € | | 342 € |

RECARGO LAMINADO ALTO BRILLO 30 PUNTOS / METRO LINEAL A SUMAR A OPCIÓN ALTO BRILLO - 61 €/ML
ANCHO DE MARCO 9,5 CM

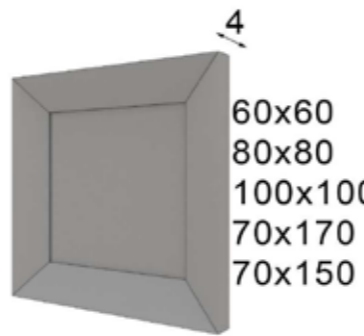
| | ANCHO | ALTO | FONDO | VOL | MATE | FRENTE ALTO BRILLO | ALTO BRILLO |
|--|--------------------------------|------|-------|----------------|--------------|--------------------|--------------|
| | cm | | | m ³ | | | |
|  | 53105 ESPEJO MARCO KORA | | | | 75 | | 94 |
| | 60 | 60 | 4 | 0,04 | 152 € | | 191 € |
| | 53106 ESPEJO MARCO KORA | | | | 93 | | 116 |
| | 80 | 80 | 4 | 0,07 | 189 € | | 236 € |
| | 53107 ESPEJO MARCO KORA | | | | 108 | | 135 |
| | 100 | 100 | 4 | 0,10 | 220 € | | 274 € |
| | 53108 ESPEJO MARCO KORA | | | | 120 | | 150 |
| | 70 | 150 | 4 | 0,10 | 244 € | | 305 € |
| | 53109 ESPEJO MARCO KORA | | | | 126 | | 158 |
| | 70 | 170 | 4 | 0,12 | 256 € | | 321 € |

RECARGO LAMINADO ALTO BRILLO 30 PUNTOS / METRO LINEAL A SUMAR A OPCIÓN ALTO BRILLO - 61 €/ML
ANCHO DE MARCO 9,5 CM

| | ANCHO | ALTO | FONDO | VOL | MATE | FRENTE ALTO BRILLO | ALTO BRILLO |
|--|-------------------|------|-------|----------------|--------------|--------------------|--------------|
| | cm | | | m ³ | | | |
|  | ESPEJO MARCO ENZO | | | | 75 | | 94 |
| | 60 | 60 | 4 | 0,04 | 152 € | | 191 € |
| | ESPEJO MARCO ENZO | | | | 93 | | 116 |
| | 80 | 80 | 4 | 0,07 | 189 € | | 236 € |
| | ESPEJO MARCO ENZO | | | | 101 | | 126 |
| 100 | 100 | 4 | 0,10 | 205 € | | 256 € | |
| ESPEJO MARCO ENZO | | | | 124 | | 155 | |
| 70 | 150 | 4 | 0,10 | 252 € | | 315 € | |
| ESPEJO MARCO ENZO | | | | 135 | | 169 | |
| 70 | 170 | 4 | 0,12 | 274 € | | 344 € | |

RECARGO LAMINADO ALTO BRILLO 30 PUNTOS / METRO LINEAL A SUMAR A OPCIÓN ALTO BRILLO - 61 €/ML
ANCHO DE MARCO 9,5 CM

| | ANCHO | ALTO | FONDO | VOL | MATE | FRENTE ALTO BRILLO | ALTO BRILLO |
|--|---|------|-------|----------------|--------------|--------------------|-------------|
| | cm | | | m ³ | | | |
|  | ESPEJO CIRCULAR METALICO DIÁMETRO 60 cm | | | | 135 | | |
| | 60 | 60 | 10 | 0,06 | 274 € | | |
| | ESPEJO CIRCULAR METALICO DIÁMETRO 80 cm | | | | 140 | | |
| | 80 | 80 | 10 | 0,11 | 285 € | | |
| ESPEJO CIRCULAR METALICO DIÁMETRO 100 cm | | | | 145 | | | |
| 100 | 100 | 10 | 0,17 | 295 € | | | |
| ESPEJO CIRCULAR METALICO DIÁMETRO 120 cm | | | | 150 | | | |
| 120 | 120 | 10 | 0,23 | 305 € | | | |

MARCO DE ESPEJO METÁLICO: SE PUEDEN UTILIZAR ACABADOS MATES Y EFECTOS METALIZADOS

| | ANCHO | ALTO | FONDO | VOL | MATE | FRENTE ALTO BRILLO | ALTO BRILLO |
|---|--------------------------------|------|-------|----------------|--------------|--------------------|-------------|
| | cm | | | m ³ | | | |
|  | ESPEJO CIRCULAR MITAD METALICO | | | | 135 | | |
| | 60 | 60 | 10 | 0,06 | 274 € | | |
| | ESPEJO CIRCULAR MITAD METALICO | | | | 138 | | |
| | 80 | 80 | 10 | 0,11 | 281 € | | |
| ESPEJO CIRCULAR MITAD METALICO | | | | 143 | | | |
| 100 | 100 | 10 | 0,17 | 291 € | | | |
| ESPEJO CIRCULAR MITAD METALICO | | | | 147 | | | |
| 120 | 120 | 10 | 0,23 | 299 € | | | |

MARCO DE ESPEJO METÁLICO: SE PUEDEN UTILIZAR ACABADOS MATES Y EFECTOS METALIZADOS

| | ANCHO | ALTO | FONDO | VOL | MATE | FRENTE ALTO BRILLO | ALTO BRILLO |
|---|--------------------------------|------|-------|----------------|--------------|--------------------|-------------|
| | cm | | | m ³ | | | |
|  | ESPEJO OVALADO METALICO 70X170 | | | | 168 | | |
| | 70 | 170 | 10 | 0,20 | 342 € | | |

MARCO DE ESPEJO METÁLICO: SE PUEDEN UTILIZAR ACABADOS MATES Y EFECTOS METALIZADOS

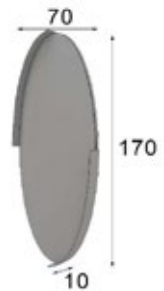
| | ANCHO | ALTO | FONDO | VOL | MATE | FRENTE ALTO BRILLO | ALTO BRILLO |
|---|-----------------------------|------|-------|----------------|--------------|--------------------|-------------|
| | cm | | | m ³ | | | |
|  | ESPEJO OVALADO SEMIMETALICO | | | | 160 | | |
| | 70 | 170 | 10 | 0,20 | 325 € | | |

MARCO DE ESPEJO METÁLICO: SE PUEDEN UTILIZAR ACABADOS MATES Y EFECTOS METALIZADOS

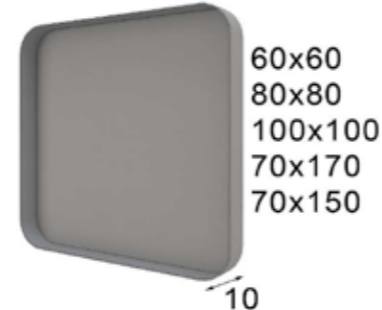
| | ANCHO | ALTO | FONDO | VOL | MATE | FRENTE ALTO BRILLO | ALTO BRILLO |
|--|---------------------------------|------|-------|----------------|--------------|--------------------|-------------|
| | cm | | | m ³ | | | |
|  | ESPEJO METALICO ESQUINAS CURVAS | | | | 122 | | |
| | 60 | 60 | 10 | 0,06 | 248 € | | |
| | ESPEJO METALICO ESQUINAS CURVAS | | | | 127 | | |
| | 80 | 80 | 10 | 0,11 | 258 € | | |
| | ESPEJO METALICO ESQUINAS CURVAS | | | | 132 | | |
| 100 | 100 | 10 | 0,17 | 268 € | | | |
| ESPEJO METALICO ESQUINAS CURVAS | | | | 136 | | | |
| 70 | 150 | 10 | 0,17 | 276 € | | | |
| ESPEJO METALICO ESQUINAS CURVAS | | | | 139 | | | |
| 70 | 170 | 10 | 0,20 | 283 € | | | |

MARCO DE ESPEJO METÁLICO: SE PUEDEN UTILIZAR ACABADOS MATES Y EFECTOS METALIZADOS

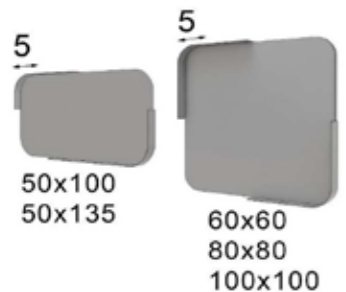
| | ANCHO | ALTO | FONDO | VOL | MATE | FRENTE ALTO BRILLO | ALTO BRILLO |
|---|--|------|-------|--------------|--------------|--------------------|-------------|
| | cm | | | m3 | | | |
|  | 21010 ESPEJO SEMIMETALICO MARCO CURVO | | | | 107 | | |
| | 60 | 60 | 5 | 0,04 | 218 € | | |
| | 21011 ESPEJO SEMIMETALICO MARCO CURVO | | | | 116 | | |
| | 80 | 80 | 5 | 0,07 | 236 € | | |
| | 21012 ESPEJO SEMIMETALICO MARCO CURVO | | | | 120 | | |
| 100 | 100 | 5 | 0,11 | 244 € | | | |
| 21014 ESPEJO SEMIMETALICO MARCO CURVO | | | | 123 | | | |
| 50 | 100 | 5 | 0,06 | 250 € | | | |
| 21015 ESPEJO SEMIMETALICO MARCO CURVO | | | | 127 | | | |
| 50 | 135 | 5 | 0,08 | 258 € | | | |

MARCO DE ESPEJO METÁLICO: SE PUEDEN UTILIZAR ACABADOS MATES Y EFECTOS METALIZADOS

| | ANCHO | ALTO | FONDO | VOL | MATE | FRENTE ALTO BRILLO | ALTO BRILLO |
|--|---|------|-------|--------------|--------------|--------------------|-------------|
| | cm | | | m3 | | | |
|  | 21030 ESPEJO METALICO PLANETARIO | | | | 144 | | |
| | 60 | 60 | 3 | 0,03 | 293 € | | |
| | 21031 ESPEJO METALICO PLANETARIO | | | | 150 | | |
| | 80 | 80 | 3 | 0,06 | 305 € | | |
| | 21032 ESPEJO METALICO PLANETARIO | | | | 157 | | |
| 100 | 100 | 3 | 0,09 | 319 € | | | |
| 21033 ESPEJO METALICO PLANETARIO | | | | 168 | | | |
| 120 | 120 | 3 | 0,13 | 342 € | | | |

MARCO DE ESPEJO METÁLICO: SE PUEDEN UTILIZAR ACABADOS MATES Y EFECTOS METALIZADOS

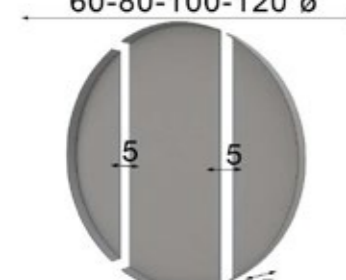
| | ANCHO | ALTO | FONDO | VOL | MATE | FRENTE ALTO BRILLO | ALTO BRILLO |
|---|--|------|-------|--------------|--------------|--------------------|-------------|
| | cm | | | m3 | | | |
|  | 21040 ESPEJO TRIPLE CIRCULAR METÁLICO | | | | 159 | | |
| | 60 | 60 | 5 | 0,04 | 323 € | | |
| | 21041 ESPEJO TRIPLE CIRCULAR METÁLICO | | | | 164 | | |
| | 80 | 80 | 5 | 0,07 | 333 € | | |
| | 21042 ESPEJO TRIPLE CIRCULAR METÁLICO | | | | 168 | | |
| 100 | 100 | 5 | 0,11 | 342 € | | | |
| 21043 ESPEJO TRIPLE CIRCULAR METÁLICO | | | | 173 | | | |
| 120 | 120 | 5 | 0,16 | 352 € | | | |

MARCO DE ESPEJO METÁLICO: SE PUEDEN UTILIZAR ACABADOS MATES Y EFECTOS METALIZADOS

| | ANCHO | ALTO | FONDO | VOL | MATE | FRENTE ALTO BRILLO | ALTO BRILLO |
|---|--|------|-------|------|--------------|--------------------|-------------|
| | cm | | | m3 | | | |
|  | 21035 JUEGO 3 ESPEJOS METALICOS PIEDRAS | | | | 246 | | |
| | 0 | 0 | 3,5 | 0,00 | 500 € | | |

MARCO DE ESPEJO METÁLICO: SE PUEDEN UTILIZAR ACABADOS MATES Y EFECTOS METALIZADOS

| | ANCHO | ALTO | FONDO | VOL | MATE | FRENTE ALTO BRILLO | ALTO BRILLO |
|---|--------------------------------------|------|-------|--------------|--------------|--------------------|-------------|
| | cm | | | m3 | | | |
|  | 21060 ESPEJO METALICO ESPIRAL | | | | 140 | | |
| | 60 | 60 | 5 | 0,04 | 285 € | | |
| | 21061 ESPEJO METALICO ESPIRAL | | | | 146 | | |
| | 80 | 80 | 5 | 0,07 | 297 € | | |
| | 21062 ESPEJO METALICO ESPIRAL | | | | 151 | | |
| 100 | 100 | 5 | 0,11 | 307 € | | | |
| 21063 ESPEJO METALICO ESPIRAL | | | | 171 | | | |
| 120 | 120 | 5 | 0,16 | 348 € | | | |

MARCO DE ESPEJO METÁLICO: SE PUEDEN UTILIZAR ACABADOS MATES Y EFECTOS METALIZADOS

| | ANCHO | ALTO | FONDO | VOL | MATE | FRENTE ALTO BRILLO | ALTO BRILLO |
|--|---------------------------------------|------|-------|--------------|--------------|--------------------|--------------|
| | cm | | | m3 | | | |
|  | 57710 ESPEJO 100x100 cm AVANTY | | | | 113 | | 141 |
| | 100 | 100 | 10 | 0,17 | 230 € | | 287 € |
| | 57711 ESPEJO 150x70 cm AVANTY | | | | 122 | | 153 |
| 70 | 150 | 10 | 0,17 | 248 € | | 311 € | |
| 57712 ESPEJO 170x70 cm AVANTY | | | | 140 | | 175 | |
| 70 | 170 | 10 | 0,20 | 285 € | | 356 € | |

LUZ LED EN MARCO INTERIOR 84 PUNTOS - 171 €
RECARGO LAMINADO ALTO BRILLO 20 PUNTOS / METRO LINEAL A SUMAR A OPCIÓN ALTO BRILLO - 41 €/ML

| | ANCHO | ALTO | FONDO | VOL | MATE | FRENTE ALTO BRILLO | ALTO BRILLO |
|---|-----------------------|------|-------|------|--------------|--------------------|-------------|
| | cm | | | m3 | | | |
|  | 42092 BANQUETA | | | | 143 | | |
| | 50 | 50 | 50 | 0,17 | 291 € | | |

INDIQUE EL TEJIDO DEL MUESTRARIO EN EL PEDIDO. TELA CLIENTE SIN COSTE ADICIONAL

PATA METÁLICA: ES POSIBLE PINTARLAS LACADO MATE Y EFECTOS METALIZADOS

| | ANCHO | ALTO | FONDO | VOL | MATE | FRENTE ALTO BRILLO | ALTO BRILLO |
|--|-------|------|-------|-----|------|--------------------|-------------|
| | cm | | | m3 | | | |



| | | | | | | | |
|--------------|---------------|----|----|------|--------------|--|--|
| 45353 | BANQUETA EN U | | | | 174 | | |
| | 75 | 50 | 50 | 0,24 | 354 € | | |

INDIQUE EL TEJIDO DEL MUESTRARIO EN EL PEDIDO. TELA CLIENTE SIN COSTE ADICIONAL

RECARGO BOTON SWAROVSKI: 51 puntos - 104 €
 RECARGO BOTON DE CRISTAL: 17 puntos - 35 €
 ESTANDAR BOTÓN TAPIZADO

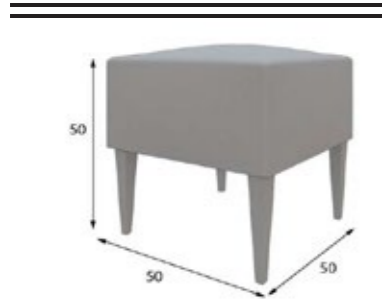

| | | | | | | | |
|--------------|----------|----|----|------|--------------|--|--------------|
| 45354 | BANQUETA | | | | 104 | | 125 |
| | 50 | 50 | 50 | 0,17 | 211 € | | 254 € |

INDIQUE EL TEJIDO DEL MUESTRARIO EN EL PEDIDO. TELA CLIENTE SIN COSTE ADICIONAL

RECARGO LAMINADO ALTO BRILLO: 40 PUNTOS

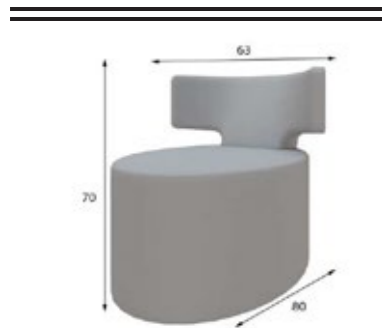

| | | | | | | | |
|--------------|----------|----|----|------|--------------|--|--|
| 45355 | BANQUETA | | | | 170 | | |
| | 63 | 70 | 80 | 0,43 | 346 € | | |

INDIQUE EL TEJIDO DEL MUESTRARIO EN EL PEDIDO. TELA CLIENTE SIN COSTE ADICIONAL



| | | | | | | | |
|--------------|----------|----|----|------|--------------|--|--------------|
| 45357 | BANQUETA | | | | 104 | | 125 |
| | 50 | 50 | 50 | 0,17 | 211 € | | 254 € |

INDIQUE EL TEJIDO DEL MUESTRARIO EN EL PEDIDO. TELA CLIENTE SIN COSTE ADICIONAL

RECARGO LAMINADO ALTO BRILLO: 40 PUNTOS

| | ANCHO | ALTO | FONDO | VOL | MATE | FRENTE ALTO BRILLO | ALTO BRILLO |
|--|-------|------|-------|-----|------|--------------------|-------------|
| | cm | | | m3 | | | |

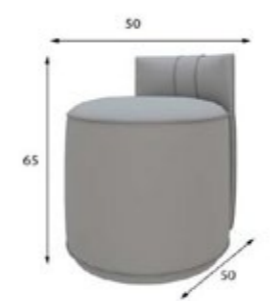

| | | | | | | | |
|--------------|----------|----|----|------|--------------|--|--|
| 45358 | BANQUETA | | | | 140 | | |
| | 50 | 65 | 50 | 0,21 | 285 € | | |

INDIQUE EL TEJIDO DEL MUESTRARIO EN EL PEDIDO. TELA CLIENTE SIN COSTE ADICIONAL

INDIQUE DE QUE COLOR DESEA LA FRANJA CENTRAL



| | | | | | | | |
|--------------|--------|----|----|------|--------------|--|--------------|
| 45359 | SILLÓN | | | | 270 | | 307 |
| | 70 | 66 | 80 | 0,45 | 549 € | | 624 € |

INDIQUE EL TEJIDO DEL MUESTRARIO EN EL PEDIDO. TELA CLIENTE SIN COSTE ADICIONAL

RECARGO LAMINADO ALTO BRILLO: 40 PUNTOS

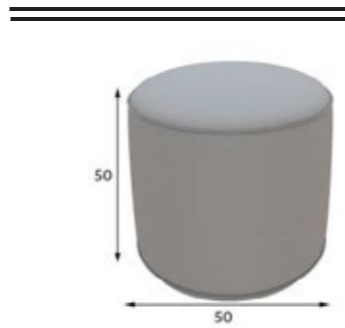

| | | | | | | | |
|--------------|------|----|----|------|--------------|--|--|
| 45361 | PUFF | | | | 95 | | |
| | 50 | 50 | 50 | 0,17 | 193 € | | |

INDIQUE EL TEJIDO DEL MUESTRARIO EN EL PEDIDO. TELA CLIENTE SIN COSTE ADICIONAL

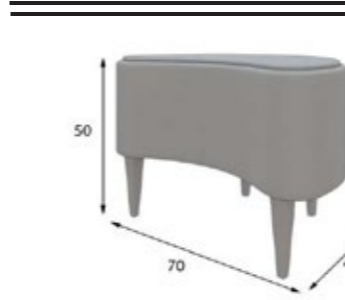

| | | | | | | | |
|--------------|----------|----|----|------|--------------|--|--------------|
| 45363 | BANQUETA | | | | 110 | | 126 |
| | 70 | 50 | 45 | 0,21 | 224 € | | 256 € |

INDIQUE EL TEJIDO DEL MUESTRARIO EN EL PEDIDO. TELA CLIENTE SIN COSTE ADICIONAL

RECARGO LAMINADO ALTO BRILLO: 40 PUNTOS

| | ANCHO | ALTO | FONDO | VOL | MATE | FRENTE ALTO BRILLO | ALTO BRILLO |
|--|-------|------|-------|----------------|------|--------------------|-------------|
| | cm | | | m ³ | | | |

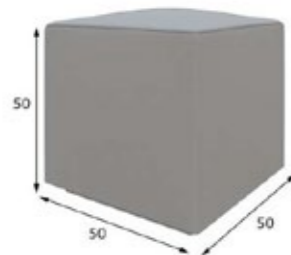

| | | | | | | | |
|--------------|----------|----|----|------|--------------|--|--|
| 45364 | BANQUETA | | | | 95 | | |
| | 50 | 50 | 50 | 0,17 | 193 € | | |

INDIQUE EL TEJIDO DEL MUESTRARIO EN EL PEDIDO. TELA CLIENTE SIN COSTE ADICIONAL

| | | | | | | | |
|--------------|---------------|----|----|------|--------------|--|--------------|
| 40806 | SILLA DEMETER | | | | 190 | | 219 |
| | 62 | 85 | 60 | 0,23 | 386 € | | 445 € |



INDIQUE EL TEJIDO DEL MUESTRARIO EN EL PEDIDO. TELA CLIENTE SIN COSTE ADICIONAL

RECARGO LAMINADO ALTO BRILLO: 40 PUNTOS

| | | | | | | | |
|--------------|-------------|----|----|------|--------------|--|--------------|
| 48884 | SILLÓN ARES | | | | 186 | | 214 |
| | 73 | 85 | 55 | 0,42 | 378 € | | 435 € |



INDIQUE EL TEJIDO DEL MUESTRARIO EN EL PEDIDO. TELA CLIENTE SIN COSTE ADICIONAL

RECARGO LAMINADO ALTO BRILLO: 40 PUNTOS

| | | | | | | | |
|--------------|------------------------------------|----|----|------|----------------|--|--|
| 58489 | JUEGO MESAS CIRCULARES TAPA MARMOL | | | | 504 | | |
| | 80 | 45 | 80 | 0,36 | 1.025 € | | |



PATA METÁLICA: ES POSIBLE PINTARLAS EN GRUPO G-1 MATE Y EFECTO METALIZADOS

| | ANCHO | ALTO | FONDO | VOL | MATE | FRENTE ALTO BRILLO | ALTO BRILLO |
|--|-------|------|-------|----------------|------|--------------------|-------------|
| | cm | | | m ³ | | | |

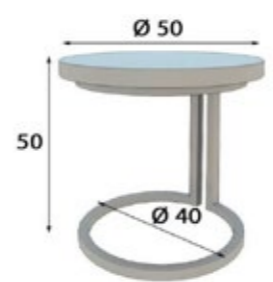

| | | | | | | | |
|--------------|---|----|----|------|--------------|--|--------------|
| 54411 | MESITA CIRCULO C/PIE METALICO CIRCULAR TAP MADERA | | | | 180 | | 225 |
| | 50 | 50 | 50 | 0,17 | 366 € | | 457 € |

PATA METÁLICA: ES POSIBLE PINTARLAS EN GRUPO G-1 MATE Y EFECTO METALIZADOS

| | | | | | | | |
|--------------|---|----|----|------|--------------|--|--------------|
| 54412 | MESITA OVALO C/PIE METALICO OVALADO T/MAD | | | | 180 | | 225 |
| | 60 | 50 | 30 | 0,13 | 366 € | | 457 € |

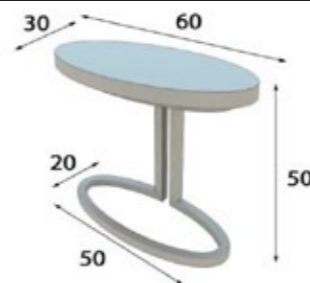

PATA METÁLICA: ES POSIBLE PINTARLAS EN GRUPO G-1 MATE Y EFECTO METALIZADOS

| | | | | | | | |
|--------------|---|----|----|------|--------------|--|--|
| 54473 | MESITA CIRCULAR T/MARMOL CON PIE METALICO | | | | 216 | | |
| | 50 | 60 | 50 | 0,20 | 439 € | | |



PATA METÁLICA: ES POSIBLE PINTARLAS EN GRUPO G-1 MATE Y EFECTO METALIZADOS

FRANCOE

Ctra. Córdoba-Málaga, km. 78.54
Tlf. +34 957 50 15 74 / +34 957 50 06 13
14900 LUCENA (Córdoba) Spain
email: info@francoehijos.com
www.francofurniture.es

