

EVOLUCION.I



# Casanova gandia

Muebles y Mesas personalizadas

Customized furniture and tables

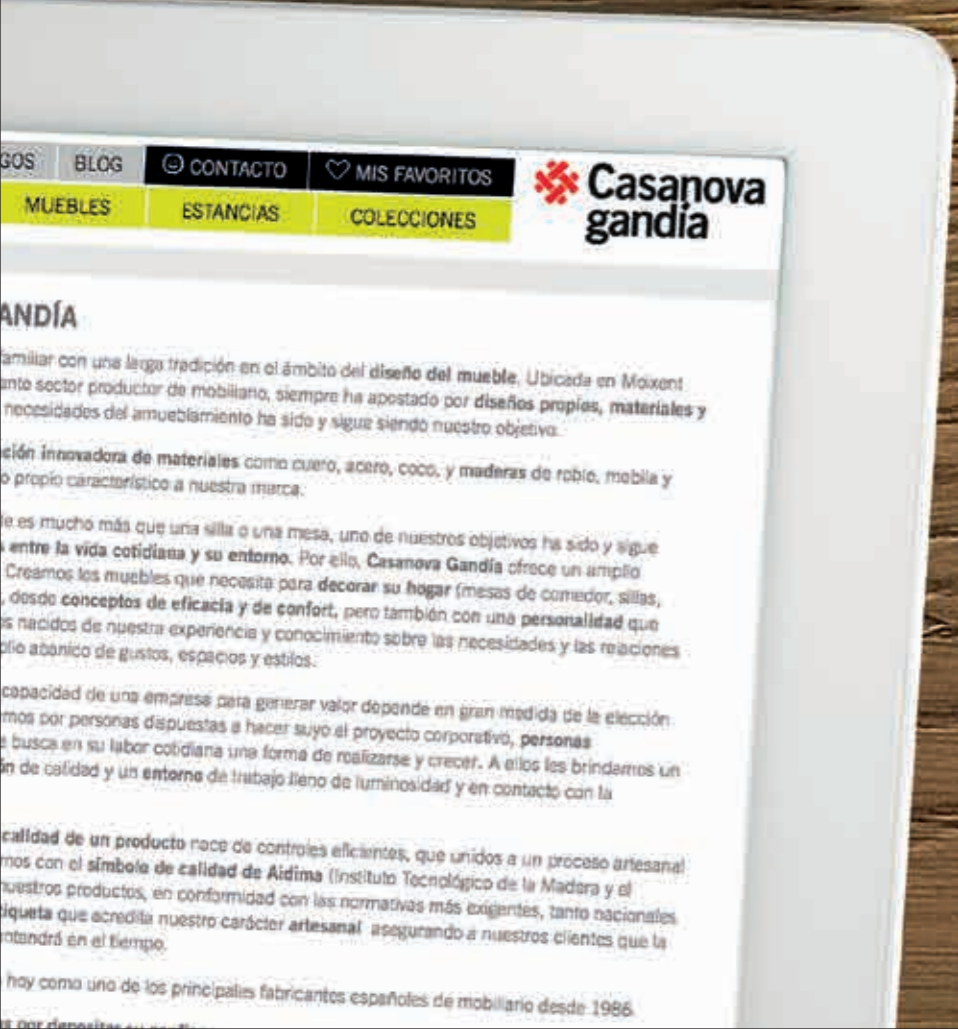

**Casanova gandia**  
 Ctra. Ontinyent km 1.3 · 46640 Moixent, Valencia  
 Teléfono: 962 290 360  
 Fax: 962 291 079  
 comercial1@casanova-gandia.com  
 www.casanova-gandia.com

Razón Social: \_\_\_\_\_ CIF: \_\_\_\_\_  
 Nombre comercial: \_\_\_\_\_ CP: \_\_\_\_\_  
 Dirección: \_\_\_\_\_ Email: \_\_\_\_\_  
 Población: \_\_\_\_\_ Fax: \_\_\_\_\_  
 Provincia: \_\_\_\_\_ REPRESENTANTE: \_\_\_\_\_  
 País: \_\_\_\_\_  
 Tel.: \_\_\_\_\_

PRESUPUESTO: \_\_\_\_\_ VALIDO HASTA: \_\_\_\_\_  
 PEDIDO: \_\_\_\_\_  
 FECHA: \_\_\_\_\_

Forma de pago: \_\_\_\_\_  
 Banco: \_\_\_\_\_  
 Nº Swift: \_\_\_\_\_  
 Portes: \_\_\_\_\_  
 Observaciones: \_\_\_\_\_

TAPAS		PATAS		MATERIAL	COLORES	PUNTO	MESA	
MADERA-GROSOR	PERFIL	FORMA	EXT.				CANT.	Nº PATA



**Crea tu propia  
mesa, siéntete  
libre.**

Create your own  
table, feel free to  
do it.

 Casanova  
gandia



# Opciones de Tapas / Types of covers

## Distintas Texturas Several Textures



Erosionada / Eroded    Arañada / Scratched    Puerta / Door    Flecha / Arrow    Mixta Metal / Mixed steel

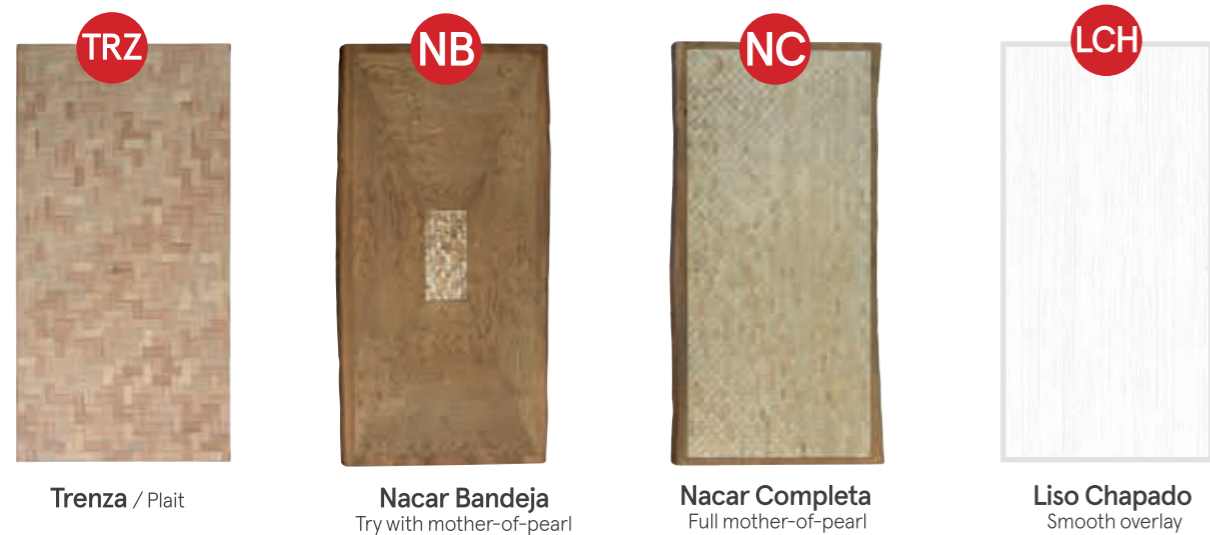

Trenza / Plait    Nacar Bandeja  
Try with mother-of-pearl

Nacar Completa  
Full mother-of-pearl

Liso Chapado  
Smooth overlay

## Distintas Maderas Several Woods



Mobila / Mobila

Mobila Vieja / Antique Mobila

Fresno / Ash wood



Roble Marinado / Royal Oak wood

Roble / Oak

Liso Chapado / Smooth overlay

## Distintos Perfiles Other silhouettes



Recto / Straight



Tronco / Trunk

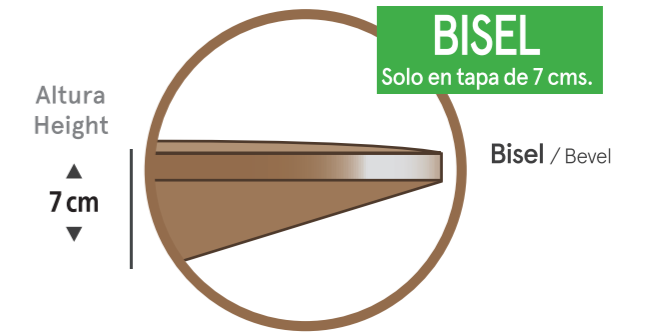

Bisel / Bevel

## Distintos Espesores Other thickness

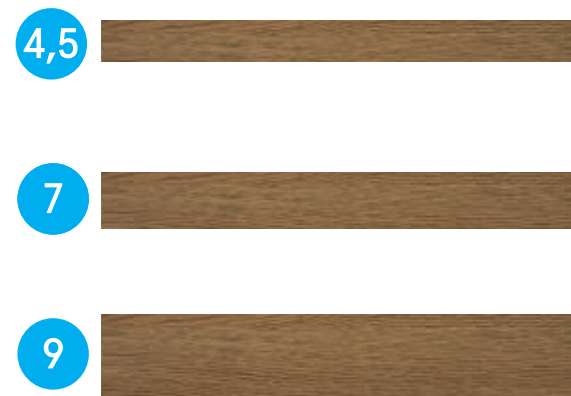

## Distintas Formas Other shapes

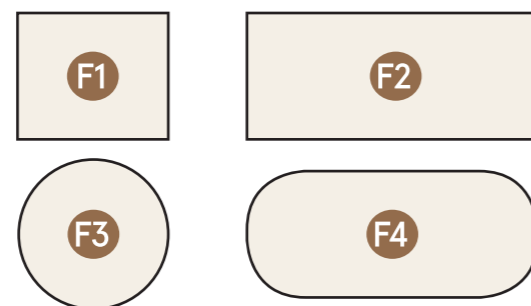

## Distintos Colores Other colours

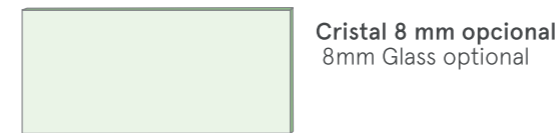
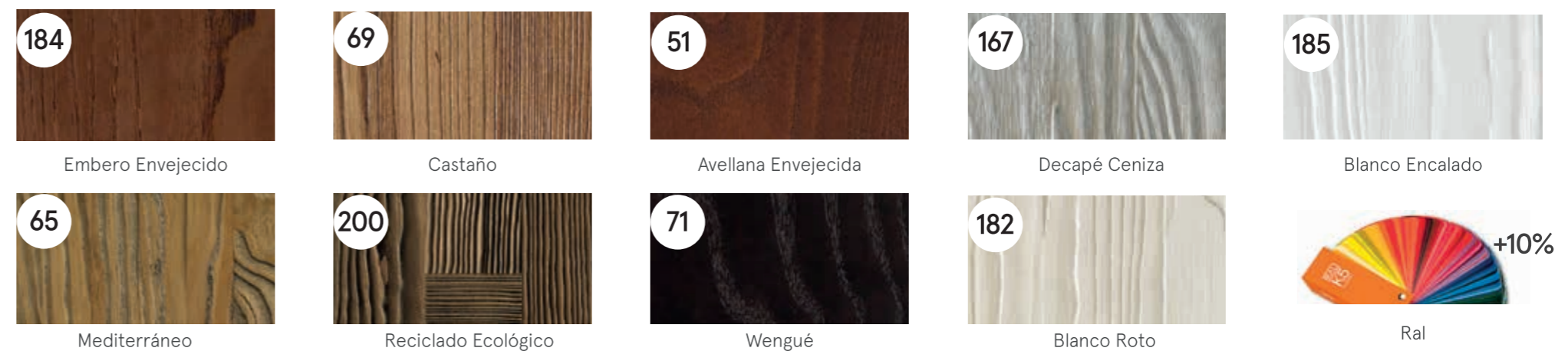

## Extensibles Extensible parts



**A** **RM** **9** **TRO** **F2**  
ARAÑADA / ROBLE MARINADO-9 / TRONCO / FORMA-F2

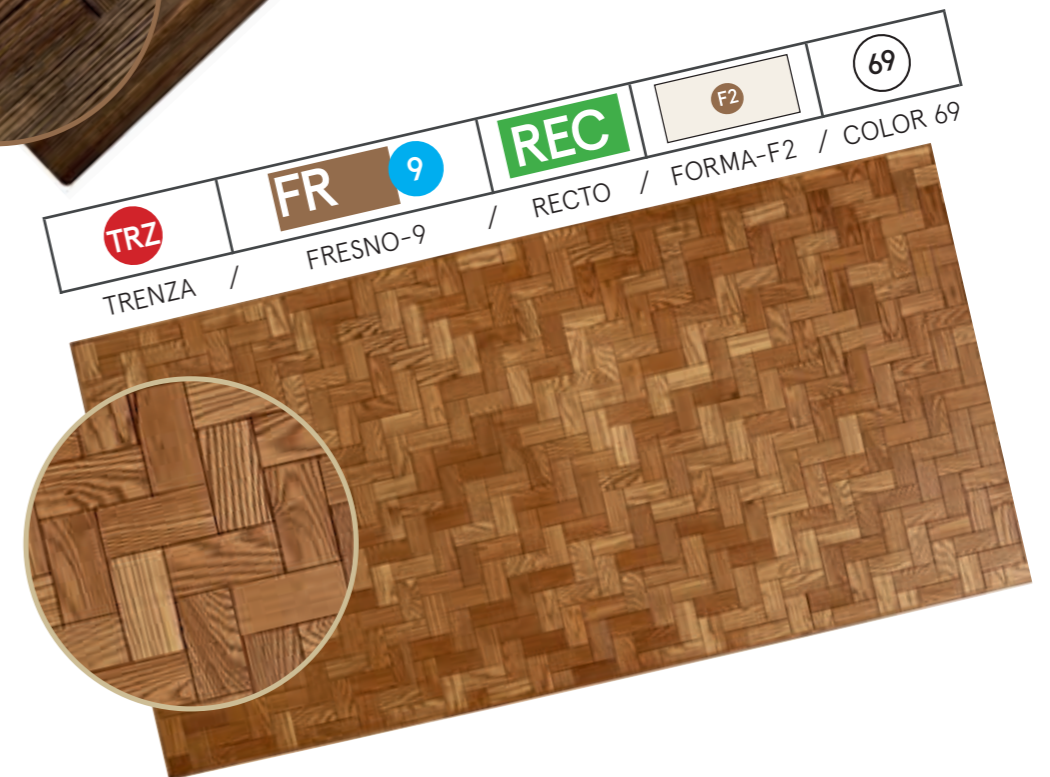
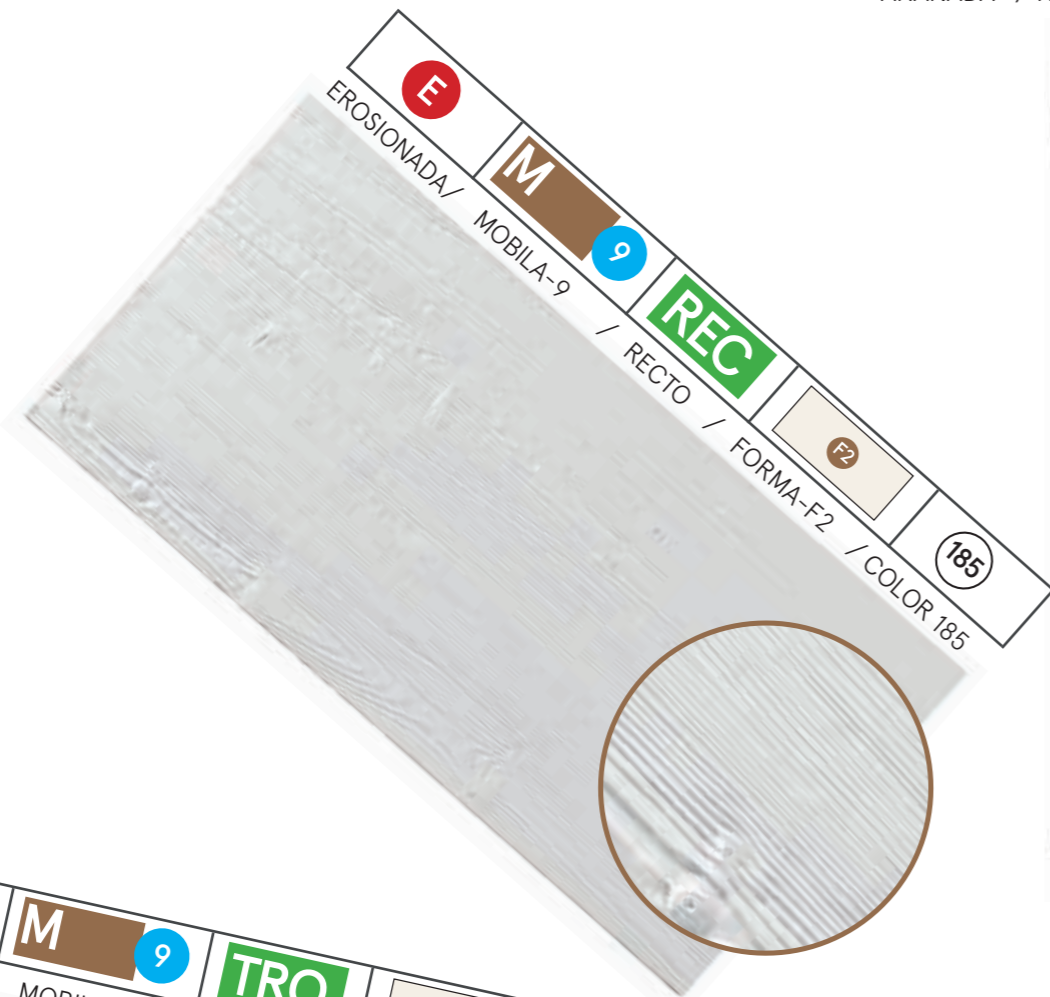

**Aquí  
encontrarás  
la combinación  
perfecta. Tú  
eliges, nosotros  
fabricamos.**

**Here you can  
find the perfect  
combination. You  
choose, we make  
it real.**

**E** **M** **9** **TRO** **F2** **167**  
EROSIONADA / MOBILA-9 / TRONCO / FORMA-F2 / COLOR 167



**A** **RM** **9** **REC** **F2**  
ARAÑADA / ROBLE MARINADO-9 / RECTO / FORMA-F2



NC RM 9 TRO F2

NACAR COMPLETA / ROBLE MARINADO-9 / TRONCO / FORMA-F2



Opción de uno o dos extensibles en todas las texturas.

The option to choose one or two extensible in all textures.

NB RM 9 TRO F2

NACAR BANDEJA / ROBLE MARINADO-9 / TRONCO / FORMA-F2



**Extensibles/Extensible parts**

El extensible para todas las tapas es común en color y madera pero respetará la textura.

The extensible parts of all the covers are common in colour and wood but we maintain the texture.

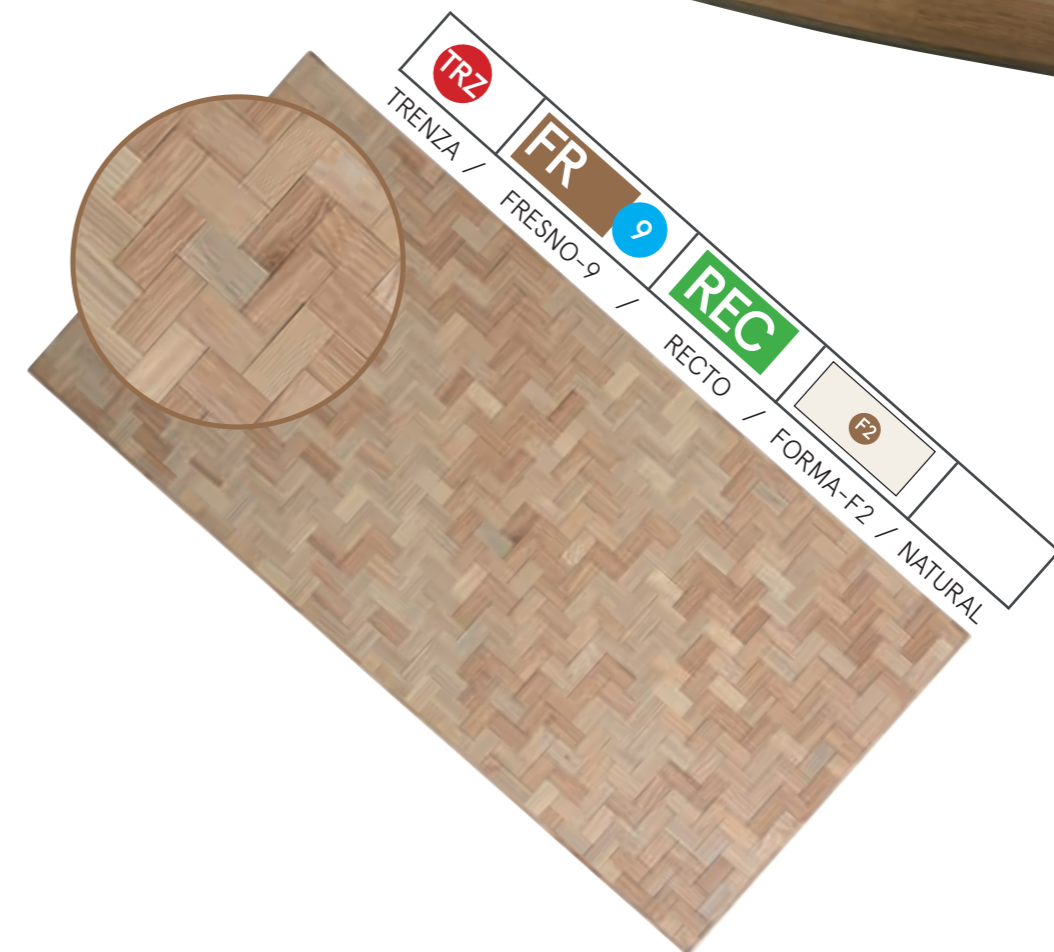
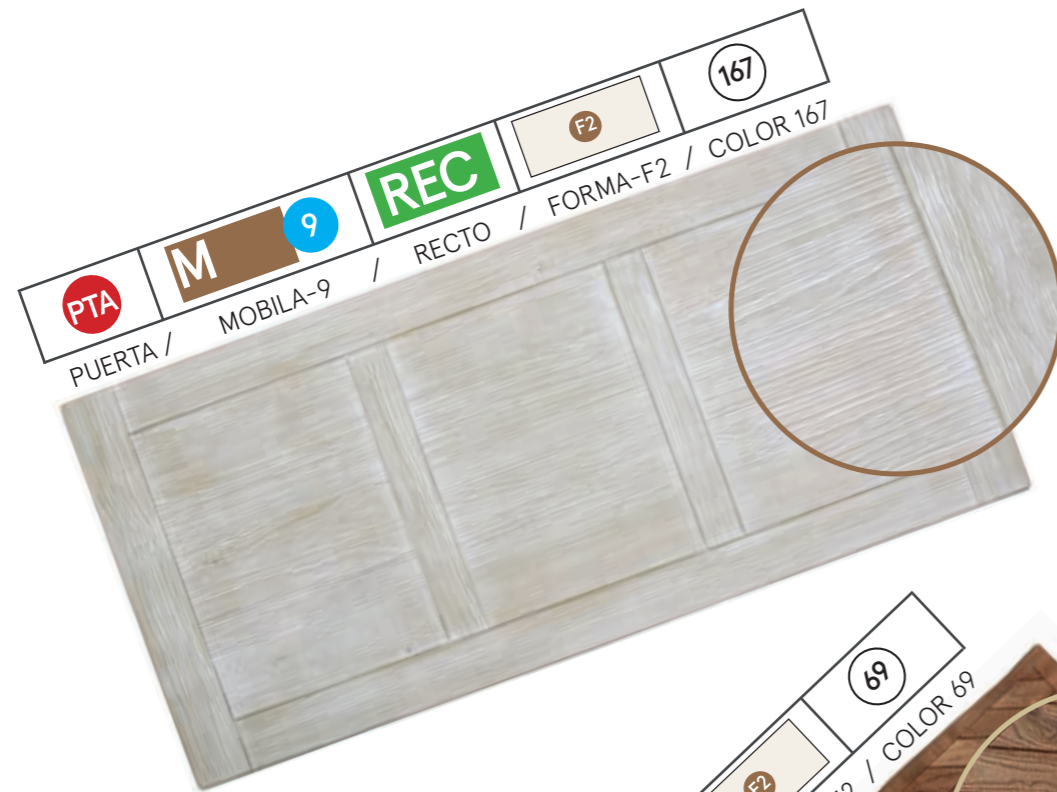
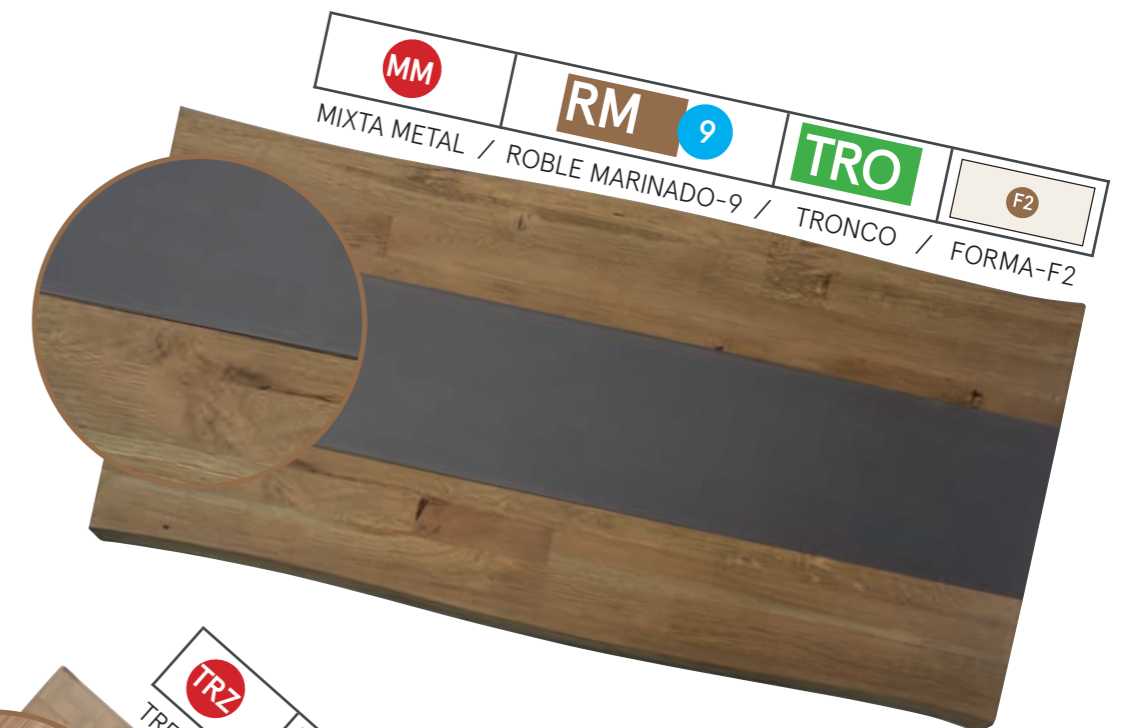

A R 9 REC F2

ARAÑADA / ROBLE-9 / RECTO / FORMA-F2 / NATURAL

# Prepara tu pedido / Make your order

Textura / Texture

La tapa con medida inferior a 2x1 se le aplicara el mismo precio que a la de 2x1

2x1

Same price for covers of 2x1m. or smaller

2x1

IMPORTANTE  
IMPORTANT

Madera / Wood

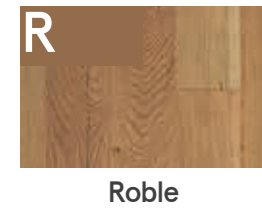
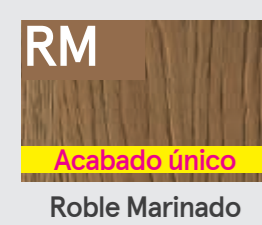
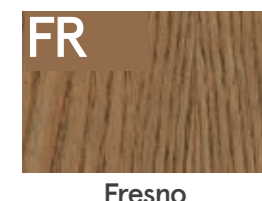

**Erosionada / Eroded**

**E**

**Arañada / Scratched**

**A**

**Puerta / Door**

**PTA**

**Flecha / Arrow**

**FLH**

**Trenza / Plait**

**TRZ**

**Nacar Bandeja**  
Try with mother-of-pearl

**NB**

**Nacar Completa**  
Full mother-of-pearl

**NC**

**Mixta Metal**  
Mixed Steel

**MM**

**Liso chapado**  
Smooth overlay

**LCH**

**M**

4,5	7	9
418 m <sup>2</sup>	508 m <sup>2</sup>	533 m <sup>2</sup>

**M**

4,5	7	9
377 m <sup>2</sup>	393 m <sup>2</sup>	410 m <sup>2</sup>

**M**

4,5	7	9
377 m <sup>2</sup>	393 m <sup>2</sup>	410 m <sup>2</sup>

**M**

4,5	7	9
638 m <sup>2</sup>	646 m <sup>2</sup>	667 m <sup>2</sup>

**M**

9
667 m <sup>2</sup>

**M**

4,5	7	9
413 m <sup>2</sup>	430 m <sup>2</sup>	446 m <sup>2</sup>

**M**

4,5	7	9
649 m <sup>2</sup>	674 m <sup>2</sup>	681 m <sup>2</sup>

**M**

4,5	7	9
811 m <sup>2</sup>	836 m <sup>2</sup>	844 m <sup>2</sup>

**MV**

4,5	7	9
501 m <sup>2</sup>	610 m <sup>2</sup>	639 m <sup>2</sup>

---

---

---

---

---

---

**MV**

4,5	7	9
839 m <sup>2</sup>	948 m <sup>2</sup>	977 m <sup>2</sup>

---

**FR**

4,5	7	9
408 m <sup>2</sup>	426 m <sup>2</sup>	443 m <sup>2</sup>

**FR**

4,5	7	9
408 m <sup>2</sup>	426 m <sup>2</sup>	443 m <sup>2</sup>

**FR**

4,5	7	9
688 m <sup>2</sup>	698 m <sup>2</sup>	721 m <sup>2</sup>

**FR**

9
721 m <sup>2</sup>

**FR**

4,5	7	9
452 m <sup>2</sup>	470 m <sup>2</sup>	502 m <sup>2</sup>

**FR**

4,5	7	9
660 m <sup>2</sup>	693 m <sup>2</sup>	705 m <sup>2</sup>

**FR**

4,5	7	9
847 m <sup>2</sup>	880 m <sup>2</sup>	892 m <sup>2</sup>

---

**RM** Acabado único

4,5	7	9
434 m <sup>2</sup>	452 m <sup>2</sup>	472 m <sup>2</sup>

**RM** Acabado único

4,5	7	9
434 m <sup>2</sup>	452 m <sup>2</sup>	472 m <sup>2</sup>

**RM** Acabado único

4,5	7	9
733 m <sup>2</sup>	744 m <sup>2</sup>	767 m <sup>2</sup>

**RM** Acabado único

9
767 m <sup>2</sup>

**RM** Acabado único

4,5	7	9
485 m <sup>2</sup>	505 m <sup>2</sup>	523 m <sup>2</sup>

**RM** Acabado único

4,5	7	9
673 m <sup>2</sup>	715 m <sup>2</sup>	731 m <sup>2</sup>

**RM** Acabado único

4,5	7	9
879 m <sup>2</sup>	921 m <sup>2</sup>	937 m <sup>2</sup>

---

**R**

4,5	7	9
434 m <sup>2</sup>	452 m <sup>2</sup>	472 m <sup>2</sup>

**R**

4,5	7	9
434 m <sup>2</sup>	452 m <sup>2</sup>	472 m <sup>2</sup>

**R**

4,5	7	9
733 m <sup>2</sup>	744 m <sup>2</sup>	767 m <sup>2</sup>

**R**

9
767 m <sup>2</sup>

**R**

4,5	7	9
485 m <sup>2</sup>	505 m <sup>2</sup>	523 m <sup>2</sup>

**R**

4,5	7	9
673 m <sup>2</sup>	715 m <sup>2</sup>	731 m <sup>2</sup>

**R**

4,5	7	9
879 m <sup>2</sup>	921 m <sup>2</sup>	937 m <sup>2</sup>

---

---

---

---

---

---

---

---

**LCH**

4,5	7	9
220 m <sup>2</sup>	280 m <sup>2</sup>	340 m <sup>2</sup>

Perfiles / Silhouettes	REC	REC	REC	REC	REC	REC	REC	REC	REC	REC
	REC	REC	REC	REC	REC	REC	REC	REC	REC	REC
	TRO	TRO	TRO	TRO	TRO	TRO	TRO	TRO	TRO	TRO
	BISEL 7 CM	BISEL 7 CM	BISEL 7 CM	BISEL 7 CM	BISEL 7 CM	BISEL 7 CM	BISEL 7 CM	BISEL 7 CM	BISEL 7 CM	BISEL 7 CM
	F1	F1	F1	F1	F1	F1	F1	F1	F1	F1
	F2	F2	F2	F2	F2	F2	F2	F2	F2	F2
	F3 + 20%	F3 + 20%	F3 + 20%	F3 + 20%	F3 + 20%	F3 + 20%	F3 + 20%	F3 + 20%	F3 + 20%	F3 + 20%
	F4 + 20%	F4 + 20%	F4 + 20%	F4 + 20%	F4 + 20%	F4 + 20%	F4 + 20%	F4 + 20%	F4 + 20%	F4 + 20%
	Solo para / Only for: F1 F2 + 574 uni.	Solo para / Only for: F1 F2 + 574 uni.	Solo para / Only for: F1 F2 + 574 uni.	Solo para / Only for: F1 F2 + 574 uni.	Solo para / Only for: F1 F2 + 574 uni.	Solo para / Only for: F1 F2 + 574 uni.	Solo para / Only for: F1 F2 + 574 uni.	Solo para / Only for: F1 F2 + 574 uni.	Solo para / Only for: F1 F2 + 574 uni.	Solo para / Only for: F1 F2 + 574 uni.

Colores / Colours	184	184	184	184	184	184	184	184	184	184
	184	184	184	184	184	184	184	184	184	184 +10%
	65	65	65	65	65	65	65	65	65	65 +10%
	51	51	51	51	51	51	51	51	51	51 +10%
	71	71	71	71	71	71	71	71	71	71 +10%
	69	69	69	69	69	69	69	69	69	69 +10%
	200	200	200	200	200	200	200	200	200	200 +10%
	167	167	167	167	167	167	167	167	167	167 +10%
	182	182	182	182	182	182	182	182	182	182 +10%
	185	185	185	185	185	185	185	185	185	185 +10%

No disponible / Not available  
 Tintes / Dyes  
 Lacas / Lacquers

El color del metal de esta tapa será el mismo que se elija para la pata  
 The metal colour of the cover is the same of the leg.

Medida mínima para 2x1  
Minimum size for 2x1

P-1

OPCIÓN TAPA CRISTAL  
CONSULTAR PRECIO  
GLASS COVER OPTIONAL  
ASK FOR PRICE

P-2

OPCIÓN TAPA CRISTAL  
CONSULTAR PRECIO  
GLASS COVER OPTIONAL  
ASK FOR PRICE

P-3

OPCIÓN TAPA CRISTAL  
CONSULTAR PRECIO  
GLASS COVER OPTIONAL  
ASK FOR PRICE

P-4

OPCIÓN TAPA CRISTAL  
CONSULTAR PRECIO  
GLASS COVER OPTIONAL  
ASK FOR PRICE

P-5

P-6

P-7

P-8

P-9

P-10

P-11

P-12

P-13

P-14

P-15

P-16

Sólo acabado foto  
Only image finish

46 ø - aprox./approx.

P-11: Solo con tapas de 9 cms y canto recto  
Only with 9cms covers and right edge

OPCIÓN TAPA CRISTAL  
CONSULTAR PRECIO  
GLASS COVER OPTIONAL  
ASK FOR PRICE



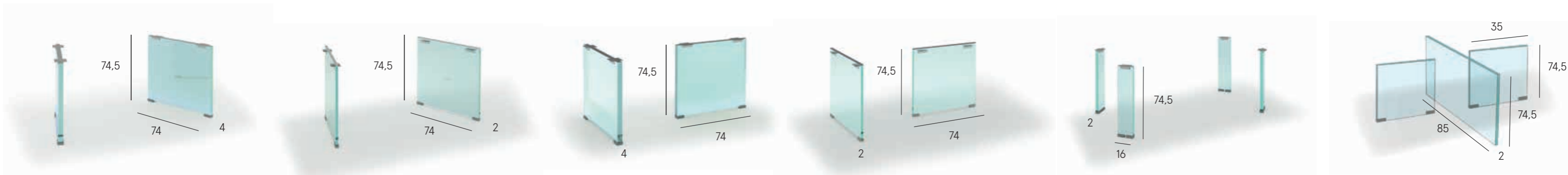

**P-17CD**

Convergente  
4 cristales

**P-17C**

Convergente  
2 cristales

**P-18PD**

Perpendicular  
4 cristales

**P-18P**

Perpendicular  
2 cristales

**P-19**

2 cristales

**P-20**

2 cristales



**P-21**

**P-22**

OPCIÓN TAPA CRISTAL / GLASS COVER OPTIONAL

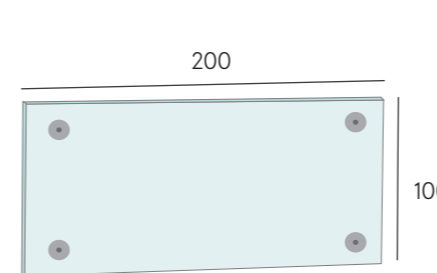

4 soldaduras  
Cristal templado de 10mm

**Precio: 584 puntos / unidad**

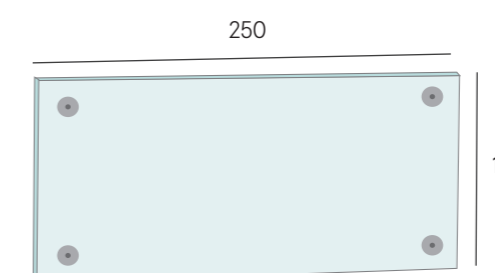

4 soldaduras  
Cristal templado de 10mm

**Precio: 716 puntos / unidad**

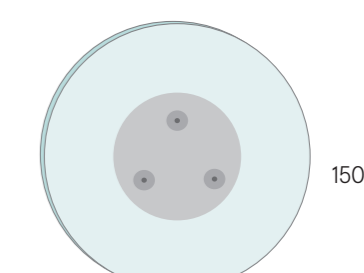

3 soldaduras + disco soporte  
Cristal templado de 10mm

**Precio: 913 puntos / unidad**

**Distintos Materiales**  
Different materials

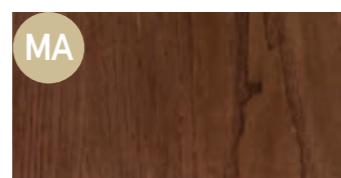

Madera



Metal



Cristal

**Distintos Colores Madera**  
Different wood colours



Embero Envejecido

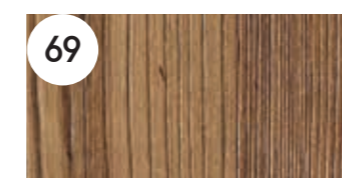

Castaño



Avellana Envejecida



Decapé Ceniza

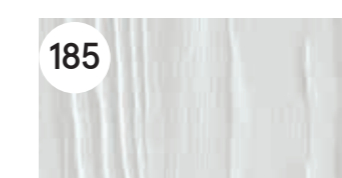

Blanco Encalado



Mediterráneo



Reciclado Ecológico



Wengué

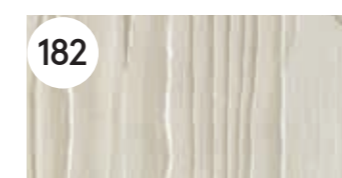

Blanco Roto



Ral

**Textura única**  
Unique texture

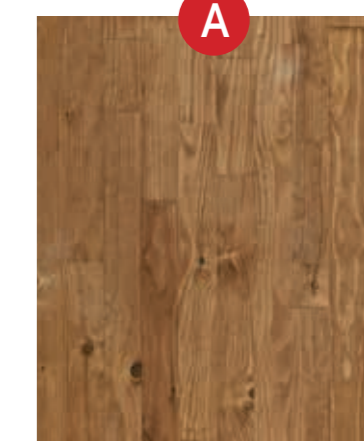

Arañada / Scratched

**Distintos Colores Metal**  
Different metal colours



Cromo Brillo



Cromo Mate



Óxido Marrón  
TEXTURIZADO / TEXTURED

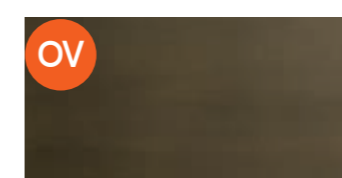

Oro Viejo  
TEXTURIZADO / TEXTURED













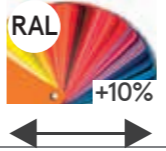

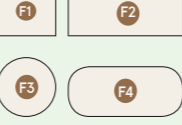
Cobre Viejo  
TEXTURIZADO / TEXTURED

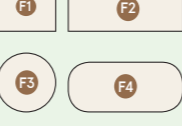

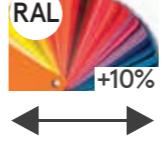
Ral

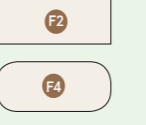
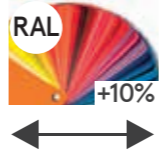
# Prepara tu pedido / Make your order

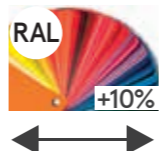
Patas / Legs	Material / Material			Formas Shapes	Colores Metal / Metal Colours					Madera - Metal Wood - Metal	Colores madera / Wood Colours								
	MA Madera / Wood	MT Metal / Metal	CR Cristal / Glass		TEXTURIZADOS - TEXTURED					RAL +10%	184	65	51	71	69	200	167	182	185
 P-1	—	✓ 931	—	F2 F4	—	—	OM	OV	CV	RAL +10%	—	—	—	—	—	—	—	—	—
<small>Medida mínima 2x1 Minimum size 2x1</small>  P-2	—	✓ 922	—	F2 F4	—	—	OM	OV	CV	RAL +10%	—	—	—	—	—	—	—	—	—
 P-3	✓ 551	✓ 632	—	F2 F4	CB	CM	OM	OV	CV	RAL +10%	184	65	51	71	69	200	167	182	185
 P-4	—	✓ 886	—	F2 F4	—	—	OM	OV	CV	RAL +10%	—	—	—	—	—	—	—	—	—
 P-5	✓ 317	✓ 496	—	F1 F2 F4	CB	CM	OM	OV	CV	RAL +10%	184	65	51	71	69	200	167	182	185
 P-6	—	✓ 915	—	F2 F4	—	—	OM	OV	CV	RAL +10%	—	—	—	—	—	—	—	—	—
 P-7	—	✓ 774	—	F1 F2 F4	CB	CM	OM	OV	CV	RAL +10%	—	—	—	—	—	—	—	—	—
 P-8	—	✓ 774	—	F1 F2 F4	CB	CM	OM	OV	CV	RAL +10%	—	—	—	—	—	—	—	—	—
 P-9	—	✓ 774	—	F1 F2 F3 F4	CB	CM	OM	OV	CV	RAL +10%	—	—	—	—	—	—	—	—	—
 P-10	✓ 243	✓ 510	—	F1 F2 F3 F4	CB	CM	OM	OV	CV	RAL +10%	—	—	—	—	—	—	—	—	—

	✓ 475	✓ 570	—		CB	CM	OM	OV	CV		184	65	51	71	69	200	167	182	185
	9 + REC			9 + REC		9 + REC			9 + REC										
	✓ 541	✓ 590	—		CB	CM	OM	OV	CV		184	65	51	71	69	200	167	182	185
	—	✓ 705	—		CB	CM	OM	OV	CV		—	—	—	—	—	—	—	—	—
	—	✓ 1430	—		CB	CM	OM	OV	CV		—	—	—	—	—	—	—	—	—
	✓ 606 Unidad/Unit	—	—		Solo acabado foto / Only image finish														
	✓ 482 Unidad/Unit	✓ 866 Unidad/Unit	—		CB	CM	OM	OV	CV		184	65	51	71	69	200	167	182	185
	—	—	x4 ✓ 1032		—	—	—	—	—		—	—	—	—	—	—	—	—	—
	—	—	x2 ✓ 630		—	—	—	—	—		—	—	—	—	—	—	—	—	—
	—	—	x4 ✓ 1032		—	—	—	—	—		—	—	—	—	—	—	—	—	—
	—	—	x2 ✓ 630		—	—	—	—	—		—	—	—	—	—	—	—	—	—
	—	—	✓ x2 670		—	—	—	—	—		—	—	—	—	—	—	—	—	—
	—	—	✓ x2 694		—	—	—	—	—		—	—	—	—	—	—	—	—	—
	—	✓ 1452	—		—	—	OM	OV	CV		—	—	—	—	—	—	—	—	—
	—	✓ 1248	—		—	—	OM	OV	CV		—	—	—	—	—	—	—	—	—

# Índice fotográfico / Images index



COMPOSICIÓN 1  
Pags. 14-15



COMPOSICIÓN 2  
Pags. 16-17



COMPOSICIÓN 3  
Pags. 18-19



COMPOSICIÓN 4  
Pags. 20



COMPOSICIÓN 5  
Pags. 21



COMPOSICIÓN 6  
Pags. 22



COMPOSICIÓN 7  
Pags. 22



COMPOSICIÓN 8  
Pags. 23



COMPOSICIÓN 9  
Pags. 23



COMPOSICIÓN 10  
Pags. 24-25



COMPOSICIÓN 11  
Pags. 26



COMPOSICIÓN 12  
Pags. 27



COMPOSICIÓN 13  
Pags. 28



COMPOSICIÓN 14  
Pags. 29



COMPOSICIÓN 15  
Pags. 30



COMPOSICIÓN 16  
Pags. 31



COMPOSICIÓN 17  
Pags. 32



COMPOSICIÓN 18  
Pags. 33



COMPOSICIÓN 19  
Pags. 34



COMPOSICIÓN 20  
Pags. 35



COMPOSICIÓN 21  
Pags. 36-37



COMPOSICIÓN 22  
Pags. 38-39



COMPOSICIÓN 23  
Pags. 40-41



COMPOSICIÓN 24  
Pags. 42



COMPOSICIÓN 25  
Pags. 43



COMPOSICIÓN 26  
Pags. 44



COMPOSICIÓN 27  
Pags. 45



COMPOSICIÓN 28  
Pags. 45



COMPOSICIÓN 29  
Pags. 46



COMPOSICIÓN 30  
Pags. 46



COMPOSICIÓN 31  
Pags. 47



COMPOSICIÓN 32  
Pags. 48



COMPOSICIÓN 33  
Pags. 49



COMPOSICIÓN 34  
Pags. 51



COMPOSICIÓN 35  
Pags. 52



COMPOSICIÓN 36  
Pags. 53



COMPOSICIÓN 37  
Pags. 54



COMPOSICIÓN 38  
Pags. 55



COMPOSICIÓN 39  
Pags. 56



COMPOSICIÓN 40  
Pags. 57



COMPOSICIÓN 41  
Pags. 58-59



COMPOSICIÓN 42  
Pags. 60-61



COMPOSICIÓN 43  
Pags. 62-63



COMPOSICIÓN 44  
Pags. 64-65



COMPOSICIÓN 45  
Pags. 66-67



COMPOSICIÓN 46  
Pags. 68



COMPOSICIÓN 47  
Pags. 69



COMPOSICIÓN 48  
Pags. 70-71



TAPA :					PRECIO : 868
PATAS :	<b>P-21</b>				PRECIO : 1.452
PRECIO COMPLETA (2 X 1): <b>2.320</b>					



SILLA MOD. **57-03020**  
 Silla Tapizada tela Saco con tachuelas y patas isa  
 TELA CLIENTE  
**FR** PRECIO : 276    PRECIO : 223  
**RM** PRECIO : 276    PRECIO : 223



OM OV CV

ESTANTERIA MOD. 70-64040

- M PRECIO : 3.544
- MV PRECIO : 4.079
- FR PRECIO : 3.761
- RM PRECIO : 3.945
- R PRECIO : 3.945
- LCH PRECIO : 2.567 (Sólo lacas)



OM OV CV

ESTANTERIA MOD. 70-64030

- M PRECIO : 1.812
- MV PRECIO : 2.079
- FR PRECIO : 1.920
- RM PRECIO : 2.012
- R PRECIO : 2.012
- LCH PRECIO : 1.323 (Sólo lacas)

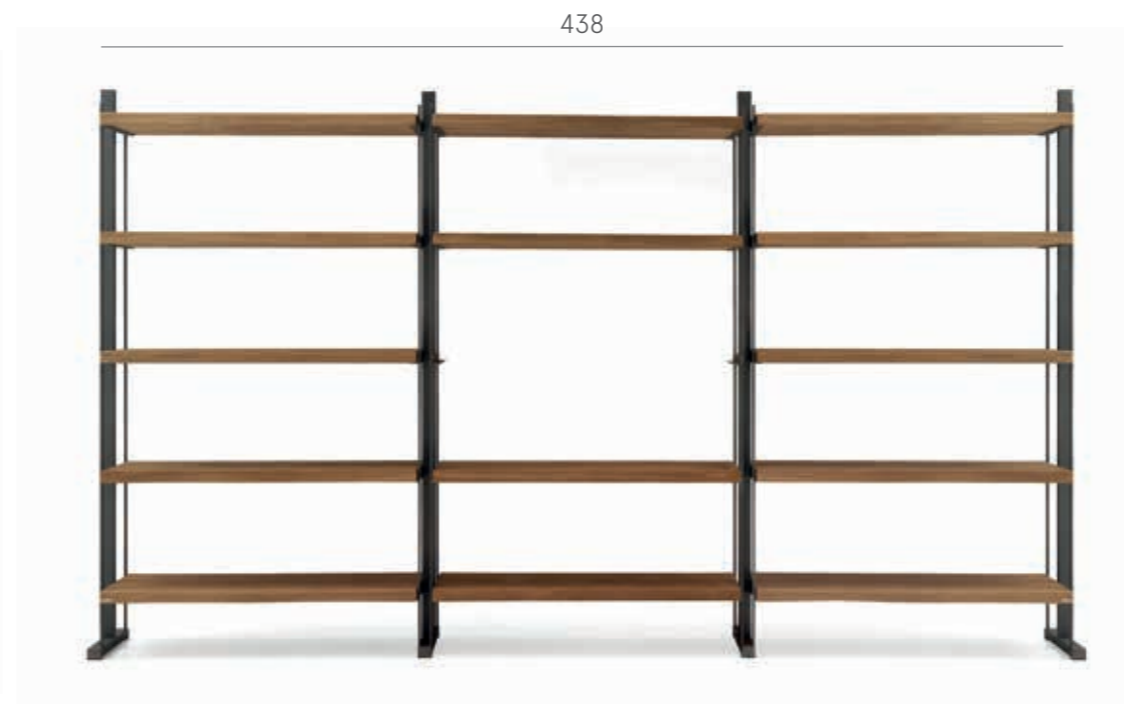

OM OV CV

ESTANTERIA MOD. 70-64050

- M PRECIO : 5.007
- MV PRECIO : 5.753
- FR PRECIO : 5.305
- RM PRECIO : 5.566
- R PRECIO : 5.566
- LCH PRECIO : 3.641 (Sólo lacas)



OM OV CV

Lámpara MOD. 72-80020  
(Bombillas incluidas)  
PRECIO : 811

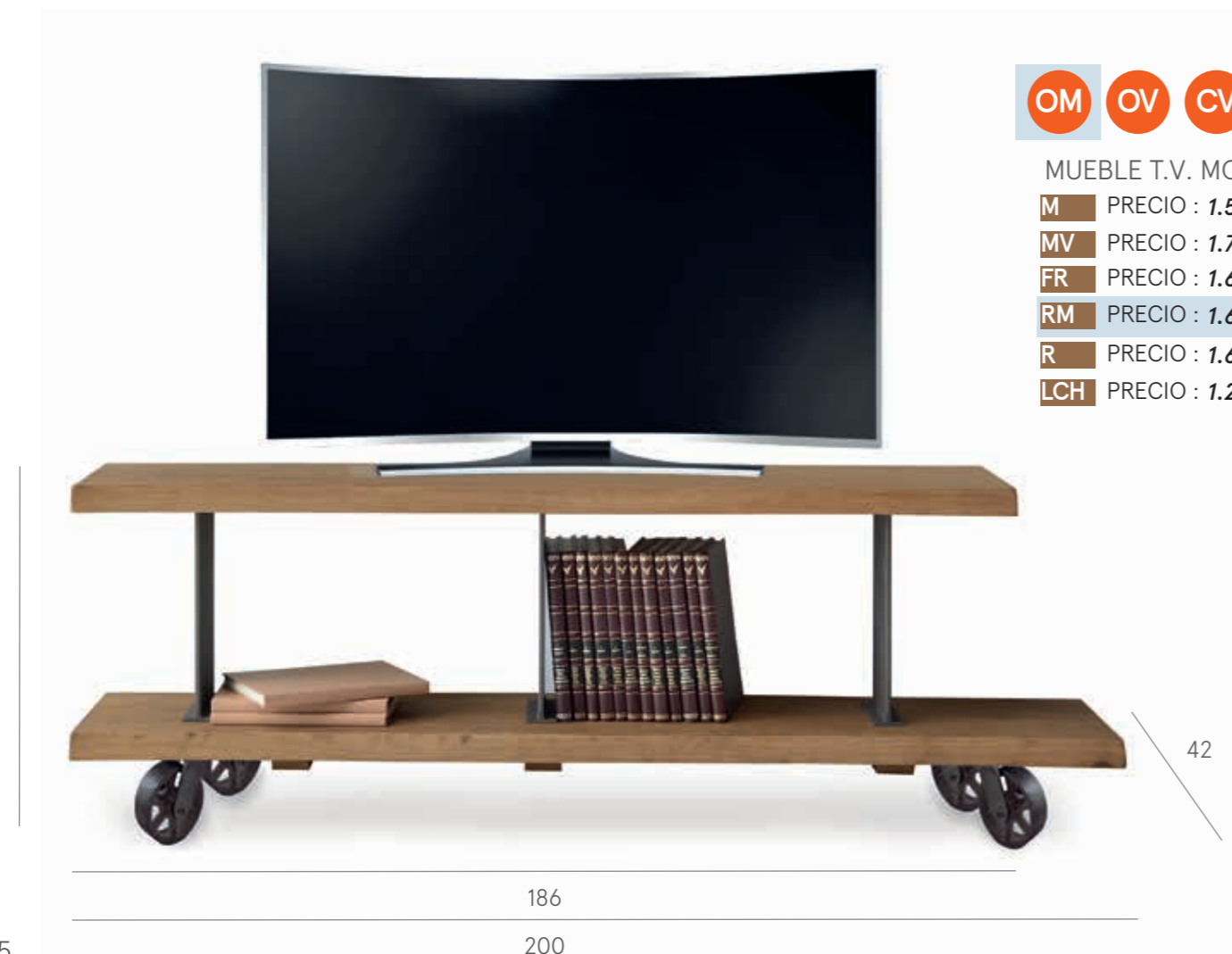

OM OV CV

MUEBLE T.V. MOD. 72-13200

- M PRECIO : 1.566
- MV PRECIO : 1.739
- FR PRECIO : 1.635
- RM PRECIO : 1.695
- R PRECIO : 1.695
- LCH PRECIO : 1.222 (Sólo lacas)

CB CM OM OV CV

MESA CENTRO MOD. 62-50120  
120 x 120 x 37

- M PRECIO : 1.048
- MV PRECIO : 1.296
- FR PRECIO : 1.132
- RM PRECIO : 1.187
- R PRECIO : 1.187
- LCH PRECIO : 815 (Sólo lacas)

OPCIÓN CON PATAS DE MADERA MISMO PRECIO / SAME PRICE WITH WOOD LEGS OPTION





TAPA :		 <b>9</b> Color unico			PRECIO : <b>1.874</b>
PATAS :	<b>P-22</b>			PRECIO : <b>1.248</b>	
PRECIO COMPLETA (2 X 1): <b>3.122</b>					

El color del metal de esta tapa será el mismo que se elija para la pata

The metal colour of the cover is the same of the leg







OM OV CV

ESTANTERIA MOD. 72-64031  
 M PRECIO : 2.611 RM PRECIO : 2.834  
 MV PRECIO : 2.908 R PRECIO : 2.834  
 FR PRECIO : 2.731 LCH PRECIO : 2.021 (Sólo lacas)

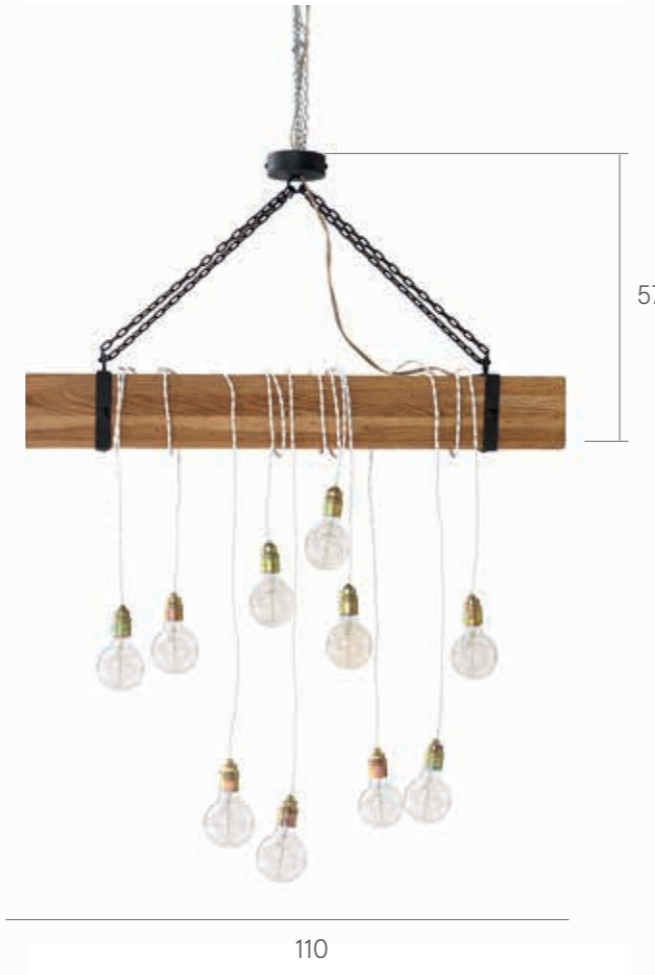

Lámpara MOD. 72-80010  
 (Bombillas incluidas)  
 RM PRECIO : 982



OM OV CV

ESTANTERIA MOD. 72-64030  
 M PRECIO : 2.236  
 MV PRECIO : 2.533  
 FR PRECIO : 2.356  
 RM PRECIO : 2.459  
 R PRECIO : 2.459  
 LCH PRECIO : 1.646 (Sólo lacas)



CB CM OM OV CV

MESA CENTRO RECTA MOD. 66-50120  
 120 x 120 x 37  
 M PRECIO : 1.048 RM PRECIO : 1.187  
 MV PRECIO : 1.296 R PRECIO : 1.187  
 FR PRECIO : 1.132 LCH PRECIO : 815 (Sólo lacas)

OPCIÓN CON PATAS DE MADERA MISMO PRECIO /  
 SAME PRICE WITH WOOD LEGS OPTION







CB CM OM OV CV

MESA CENTRO TRONCO MOD. 66-50120P  
 120 x 120 x 37  
 RM PRECIO : 1.209  
 R PRECIO : 1.209  
 FR PRECIO : 1.132

OPCIÓN CON PATAS DE MADERA MISMO PRECIO /  
 SAME PRICE WITH WOOD LEGS OPTION





TAPA :	 A	 RM	 4,5	 REC	 F2	PRECIO : 868
PATAS :	<b>P-14</b>	 MT	 OM	PRECIO : 1.430		
PRECIO COMPLETA (2 X 1): 2.298						

En el aparador y la mesita el armazón siempre será en LCH. Sólo se podrá variar los frontales de puertas y cajones en macizo.

The frame of the buffet and the bedside table is always made in LCH. Only the front of the doors and drawers can be changed in solid wood.

99,5 Ø

ESPEJO MOD. 64-62100

- M PRECIO : 535
- MV PRECIO : 642
- FR PRECIO : 577
- RM PRECIO : 615
- R PRECIO : 615

5,5  
(Grosor)

APARADOR MOD. 70-07010

- M PRECIO : 1.605
- MV PRECIO : 1.926
- FR PRECIO : 1.733
- RM PRECIO : 1.844
- R PRECIO : 1.844



- CB
- CM
- OM
- OV
- CV

BANQUETA MOD. 62-36200-2

- M PRECIO : 738
- MV PRECIO : 795
- FR PRECIO : 761
- RM PRECIO : 781
- R PRECIO : 781
- LCH PRECIO : 700 (Sólo lacas)



Lámpara MOD. 72-80010  
(Bombillas incluidas)  
RM PRECIO : 982

MESITA MOD. 70-30020

- M PRECIO : 481
- MV PRECIO : 575
- FR PRECIO : 518
- RM PRECIO : 550
- R PRECIO : 550



120 Ø



- CB
- CM
- OM
- OV
- CV

MESA CENTRO MOD. 62-50120R

- M PRECIO : 1.048
- MV PRECIO : 1.296
- FR PRECIO : 1.132
- RM PRECIO : 1.187
- R PRECIO : 1.187
- LCH PRECIO : 815 (Sólo lacas)

- CB
- CM
- OM
- OV
- CV

MESA RINCÓN MOD. 62-52010P

50 x 50 x 55

- M PRECIO : 351
- MV PRECIO : 400
- FR PRECIO : 370
- RM PRECIO : 388
- R PRECIO : 388
- LCH PRECIO : 191 (Sólo lacas)

MESA CENTRO MOD. 63-50121

120 x 120 x 34

- M PRECIO : 733
- MV PRECIO : 808
- FR PRECIO : 763
- RM PRECIO : 788
- R PRECIO : 788

La tapa siempre será en LCH, sólo se podrá cambiar la madera de la base.

The cover is always made of LCH. It is only possible to change the wood of the base.





MESA RINCÓN MOD. 58-52010

55 x 55 x 50

M PRECIO : 499 (Unidad/Unit)

RM PRECIO : 573 (Unidad/Unit)

MV PRECIO : 598 (Unidad/Unit)

R PRECIO : 573 (Unidad/Unit)

FR PRECIO : 538 (Unidad/Unit)

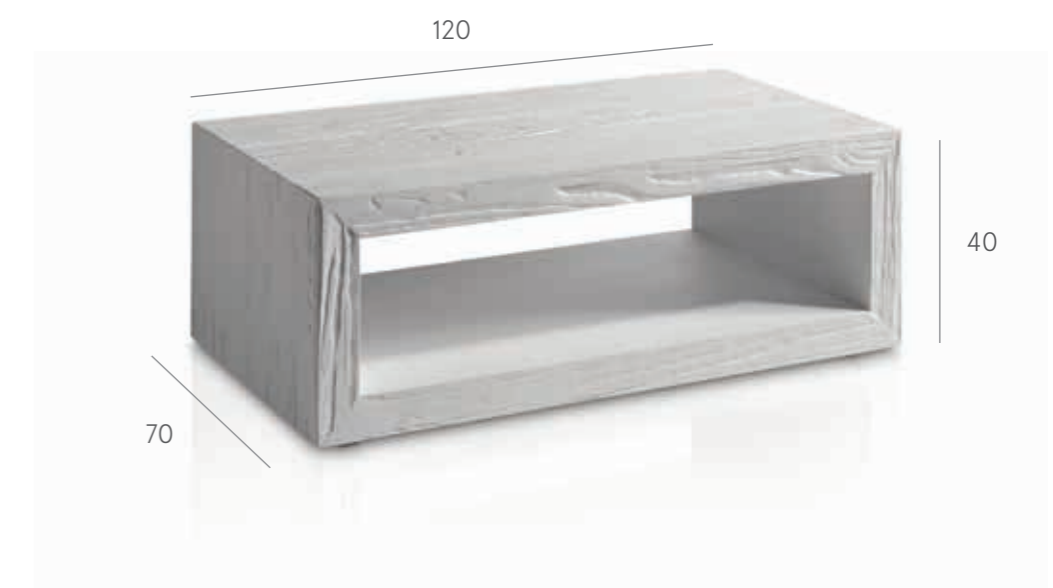

MESA CENTRO MOD. 58-50020

M PRECIO : 755

RM PRECIO : 868

MV PRECIO : 905

R PRECIO : 868

FR PRECIO : 814

TAPA :							PRECIO : 1.066
PATAS :	<b>P-8</b>			PRECIO : 774			
PRECIO COMPLETA (2 X 1): 1.840							



ESTANTERIA MOD. 72-64050

- M PRECIO : 4.047
- MV PRECIO : 4.510
- FR PRECIO : 4.233
- RM PRECIO : 4.400
- R PRECIO : 4.400
- LCH PRECIO : 3.166 (Sólo lacas)

(Contenedores no incluidos / Containers not included)



Contenedor 2 asas  
pequeño  
MOD. 72-74010  
50x35x15  
PRECIO : 177

Contenedor 2 asas  
Grande  
MOD. 72-74020  
50x35x35  
PRECIO : 213



TAPA :							RECICLADO ECOLÓGICO	PRECIO : 1.278
PATAS :	P-7	MT	OM	PRECIO : 774				
PRECIO COMPLETA (2 X 1): 2.052								





SILLA MOD. 57-03020  
Silla Tapizada tela Saco con tachuelas y patas isabelinas

FR	PRECIO : 276	TELA CLIENTE	PRECIO : 223
RM	PRECIO : 276	PRECIO : 223	

107  
47 56

TAPA :							PRECIO : 1.439
--------	--	--	--	--	--	--	----------------

PATAS :				PRECIO : 774
---------	--	--	--	--------------

PRECIO COMPLETA ( 150 cms. Ø): 2.213

TAPA :							PRECIO : 1.439
--------	--	--	--	--	--	--	----------------

PATAS :			PRECIO : 670
---------	--	--	--------------

PRECIO COMPLETA ( 150 cms. Ø): 2.109



**Casanova**  
gandia

TAPA :							PRECIO : 1.066
--------	--	--	--	--	--	--	----------------

PATAS :	<b>P-11</b>			PRECIO : 475
---------	-------------	--	--	--------------

PRECIO COMPLETA (2 X 1): **1.541**

El armazón en la madera que se elija, y los frentes de las puertas en macizo o chapa.

The frame of the chosen wood and the front of the doors of solid wood or veneer.



VITRINA MIXTA MOD. **58-11030**

<b>M</b>	PRECIO : 1.023	<b>RM</b>	PRECIO : 1.176
<b>MV</b>	PRECIO : 1.228	<b>R</b>	PRECIO : 1.176
<b>FR</b>	PRECIO : 1.105		



MESA CENTRO - PATA MADERA MOD. **60-50020**

<b>M</b>	PRECIO : 834	<b>RM</b>	PRECIO : 959
<b>MV</b>	PRECIO : 1.000	<b>R</b>	PRECIO : 959
<b>FR</b>	PRECIO : 901	<b>LCH</b>	PRECIO : 562 (Sólo lacas)

MESA CENTRO - PATA METAL MOD. **60-50020-1**  
INCREMENTO PRECIO : 217



TAPA :							PRECIO : 820
--------	--	--	--	--	--	--	--------------

PATAS :	<b>P-11</b>			PRECIO : 570
---------	-------------	--	--	--------------

PRECIO COMPLETA (2 X 1): **1.390**





VITRINA MOD. **15-11030**

CHAPA	<b>FR</b>	PRECIO : 751
CHAPA	<b>RM</b>	PRECIO : 864
CHAPA	<b>R</b>	PRECIO : 864



VITRINA MOD. **15-11040**

CHAPA	<b>FR</b>	PRECIO : 889
CHAPA	<b>RM</b>	PRECIO : 1.022
CHAPA	<b>R</b>	PRECIO : 1.022

TAPA :							PRECIO : 1.279
PATAS :	<b>P-20</b>		PRECIO : 694				
PRECIO COMPLETA 2x1 : 1.973							







APARADOR MOD. 27-07020

- CHAPA FR PRECIO : 1.520
- CHAPA RM PRECIO : 1.520
- CHAPA R PRECIO : 1.520

VITRINA MOD. 27-09020

- CHAPA FR PRECIO : 1.945
- CHAPA RM PRECIO : 1.945
- CHAPA R PRECIO : 1.945

83

En el aparador y la vitrina, la opción RM y R, será toda la pieza en el mismo material elegido.

Same material for the buffet and glass cabinet in the options Royal Oak and Oak.



180

40

140



107

47

56

SILLA MOD. 57-03020

Silla Tapizada tela Saco con tachuelas y patas isabelinas

- FR PRECIO : 276
- RM PRECIO : 276

TELA CLIENTE  
PRECIO : 223  
PRECIO : 223



ESPEJO MOD. 62-62010RE  
100 x 5 x 100

- M PRECIO : 450
- MV PRECIO : 490
- FR PRECIO : 470
- RM PRECIO : 480
- R PRECIO : 480

- CB
- CM
- OM
- OV
- CV

CONSOLA MOD. 63-58020  
120 x 30 x 83

- M PRECIO : 528
- MV PRECIO : 558
- FR PRECIO : 542
- RM PRECIO : 555
- R PRECIO : 555

En la consola el casco será siempre en LCH y se podrá cambiar el frente de cajones.

The frame of the console table is always made in LCH but the front of the drawers can be changed.



TAPA :							PRECIO : 1.066
PATAS :	<b>P-15</b>		PRECIO 2 PATAS : 1.212				
PRECIO COMPLETA (2x1): 2.278							



SILLA MOD. **58-03020 (Mixta)**  
Silla tapizada patas isabelinas  
respaldo Mobila Erosionada C/167

	TELA CLIENTE
<b>FR</b>	PRECIO : 241
<b>RM</b>	PRECIO : 241
	PRECIO : 230
	PRECIO : 230



SILLA MOD. **27-03020**  
Silla tapizada patas recta  
con copete

	TELA CLIENTE
<b>FR</b>	PRECIO : 225
<b>RM</b>	PRECIO : 225
	PRECIO : 177
	PRECIO : 177



SILLA MOD. **57-03010**  
Silla tapizada patas isabelinas

	TELA CLIENTE
<b>FR</b>	PRECIO : 221
<b>RM</b>	PRECIO : 221
	PRECIO : 178
	PRECIO : 178



SILLA MOD. **58-03030 (Mixta)**  
Silla medallón respaldo erosionado C/184  
TELA CLIENTE

FR PRECIO : 312    PRECIO : 299  
RM PRECIO : 312    PRECIO : 299



ESPEJO MOD. **62-62011RE**  
100 x 5 x 100

M PRECIO : 400  
MV PRECIO : 440  
FR PRECIO : 420  
RM PRECIO : 430  
R PRECIO : 430

CONSOLA MOD. **63-58060**  
120 x 30 x 80

M PRECIO : 580  
MV PRECIO : 610  
FR PRECIO : 594  
RM PRECIO : 607  
R PRECIO : 607

En la consola el casco será siempre en LCH y se podrá cambiar el frente de cajones.

The frame of the console table is always made in LCH but the front of the drawers can be changed.

TAPA :		4,5				PRECIO : 1.129
PATAS :	P-15	MA	PRECIO : 606			
PRECIO COMPLETA ( 150 cms. Ø): 1.735						



TAPA :							PRECIO : 1.442
PATAS :	<b>P-6</b>			PRECIO : 915			
PRECIO COMPLETA (2x1): <b>2.357</b>							



ESTANTERIA MOD. 70-64030		
	PRECIO : 1.812	
	PRECIO : 2.079	
	PRECIO : 1.920	
	PRECIO : 2.012	
	PRECIO : 2.012	
	PRECIO : 1.323 (Sólo lacas)	

TAPA :				
			PRECIO : 1.442	
PATAS :	<b>P-10</b>			PRECIO : 510
PRECIO COMPLETA (120 x 120): <b>1.952</b>				



ESTANTERIA MOD. 72-64050

M PRECIO : 4.047 RM PRECIO : 4.400

MV PRECIO : 4.510 R PRECIO : 4.400

FR PRECIO : 4.233 LCH PRECIO : 3.166 (Sólo lacas)

(Contenedores no incluidos / Containers not included)



Contenedor 2 asas  
pequeño  
MOD. 72-74010  
50x35x15  
PRECIO : 177



Contenedor 2 asas  
Grande  
MOD. 72-74020  
50x35x35  
PRECIO : 213



TAPA :							PRECIO : 1.442
PATAS :				PRECIO : 570			
PRECIO COMPLETA (2x1): 2.012							



MOD. 62-3620P  
Banqueta tela Saco abotonada  
120 x 40 x 55 TELA CLIENTE  
PRECIO : 464 PRECIO : 448



MOD. 62-36200P  
Banqueta tela Saco abotonada  
200 x 40 x 55 TELA CLIENTE  
PRECIO : 879 PRECIO : 853

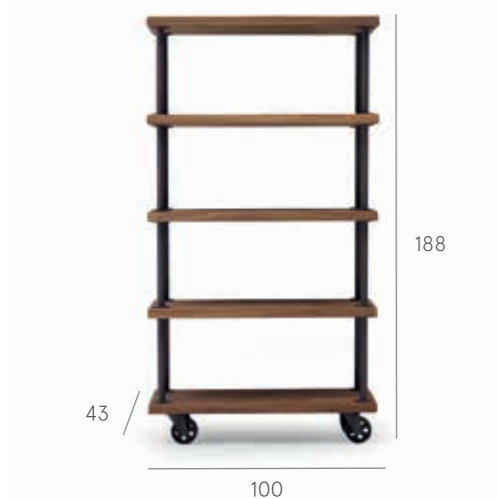

- OM** **OV** **CV**
- ESTANTERIA MOD. 72-64040
- M** PRECIO : 2.216
- MV** PRECIO : 2.443
- FR** PRECIO : 2.308
- RM** PRECIO : 2.386
- R** PRECIO : 2.386
- LCH** PRECIO : 1.830 (Sólo lacas)

TAPA :						PRECIO : 816
PATAS :	<b>P-10</b>			PRECIO : 510		
PRECIO COMPLETA (2x1): 1.326						





SILLA MOD. **57-03020**  
 Silla Tapizada tela Saco con tachuelas  
 y patas isabelinas

FR PRECIO : 276  
 RM PRECIO : 276

TELA CLIENTE  
 PRECIO : 223  
 PRECIO : 223

TAPA :							PRECIO : 886
PATAS :				PRECIO : 931			
PRECIO COMPLETA (2x1): 1.817							



OM OV CV

ESTANTERIA MOD. 70-64030

- M PRECIO : 1.812
- MV PRECIO : 2.079
- FR PRECIO : 1.920
- RM PRECIO : 2.012
- R PRECIO : 2.012
- LCH PRECIO : 1.323 (Sólo lacas)



TAPA :					PRECIO : 1.346
PATAS :	<b>P-18PD</b>		PRECIO : 1.032		
PRECIO COMPLETA (2x1): 2.378					

 Casanova gandia



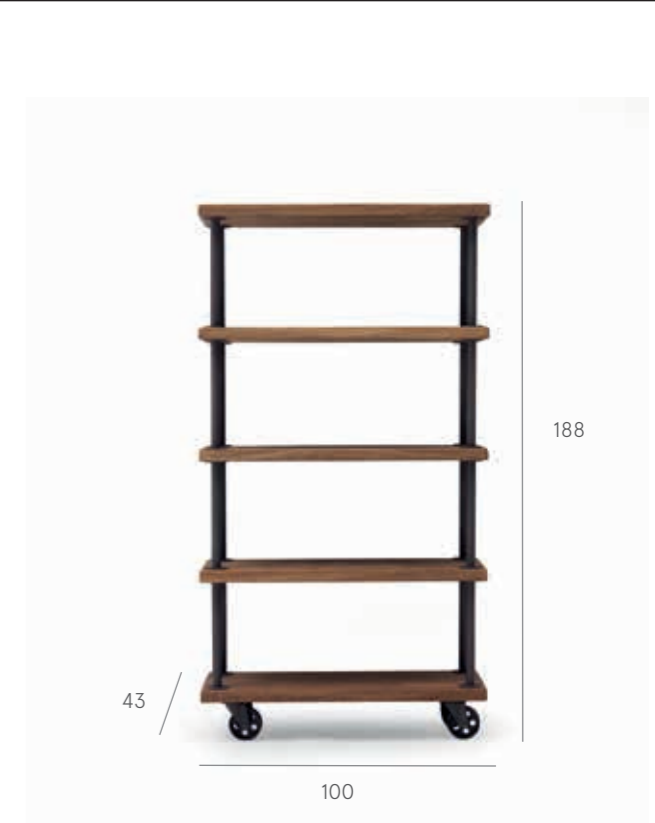

- OM
OV
CV
- ESTANTERIA MOD. 72-64040
- M** PRECIO : 2.216
- MV** PRECIO : 2.443
- FR** PRECIO : 2.308
- RM** PRECIO : 2.386
- R** PRECIO : 2.386
- LCH** PRECIO : 1.830 (Sólo lacas)











TAPA :							PRECIO : 1.396
PATAS :				PRECIO : 886			
PRECIO COMPLETA (2x1): 2.282							



- SILLA MOD. 57-03020  
Silla Tapizada tela Saco con tachuelas y patas isabelinas
- FR** PRECIO : 276      TELA CLIENTE PRECIO : 223
  - RM** PRECIO : 276      TELA CLIENTE PRECIO : 223

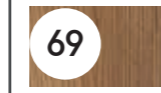

**Casanova  
gandia**





TAPA :							PRECIO: 886
PATAS :				PRECIO : 774			
PRECIO COMPLETA (2x1): 1.660							

Lámpara MOD. 72-80010  
(Bombillas incluidas)  
110 x 57  
 PRECIO : 982







ESPEJO MOD. 62-62010  
100 x 4 x 100

	PRECIO : 437
	PRECIO : 525
	PRECIO : 472
	PRECIO : 503
	PRECIO : 503

CONSOLA MOD. 62-58020  
120 x 34 x 80

	PRECIO : 768
	PRECIO : 845
	PRECIO : 799
	PRECIO : 826
	PRECIO : 826

En la consola, la tapa se podrá elegir la madera y en los cajones se podrá elegir la chapa.

In the console table you can choose the wood for the cover and the veneer for the drawers.

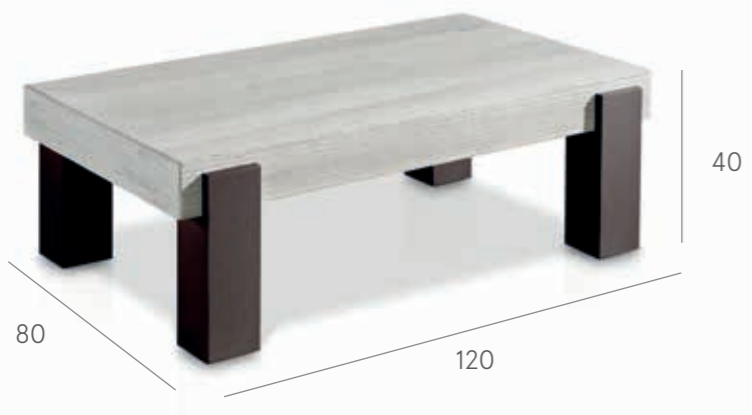

MESA CENTRO - PATA MADERA MOD. 60-50020

- M PRECIO : 834    RM PRECIO : 959
  - MV PRECIO : 1.000    R PRECIO : 959
  - FR PRECIO : 901    LCH PRECIO : 562 (Sólo lacas)
- MESA CENTRO - PATA METAL MOD. 60-50020-1  
INCREMENTO PRECIO : 217



TAPA :	A	RM <span style="color: blue; font-weight: bold; font-size: 1.2em;">9</span> <small>Color unico</small>	REC	F2	PRECIO : 944
PATAS :	P-11	MT	CB	PRECIO : 570	
EXTENSIBLE :	EXT <small>45 cms.</small>	RM <span style="color: blue; font-weight: bold; font-size: 1.2em;">9</span> <small>Color unico</small>	PRECIO 2 EXT. : 1.148		
PRECIO COMPLETA (2x1): 2.662					





TAPA :						PRECIO : 816
PATAS :	<b>P-16</b>			PRECIO 2 PATAS : 964		
PRECIO COMPLETA (2x1): 1.780						

CONJUNTO 4 ESPEJOS MOD. 64-62040

M	PRECIO : 822
MV	PRECIO : 986
FR	PRECIO : 888
RM	PRECIO : 945
R	PRECIO : 945



SILLA MOD. 57-03020

Silla Tapizada tela Saco con tachuelas y patas isabelinas

FR	PRECIO : 276	TELA CLIENTE	PRECIO : 223
RM	PRECIO : 276	PRECIO : 223	



107

ESPEJO MOD. 65-62010  
85 x 4 x 85

M	PRECIO : 409
MV	PRECIO : 491
FR	PRECIO : 442
RM	PRECIO : 470
R	PRECIO : 470

CONSOLA MOD. 65-58020  
120 x 30 x 85

M	PRECIO : 869
MV	PRECIO : 1.043
FR	PRECIO : 938
RM	PRECIO : 999
R	PRECIO : 999



APARADOR MOD. 64-07020

CHAPA	FR	PRECIO : 1.497
CHAPA	RM	PRECIO : 1.497
CHAPA	R	PRECIO : 1.497

En el aparador el armazón siempre será en LCH. Sólo se podrá variar los frontales de puertas y cajones.

The frame of the buffet is made of LCH. Only the front of the doors and drawers can be different.



190

50



Tapa  
**BISEL**



SILLA MOD. **57-03020**  
Silla Tapizada tela Saco con tachuelas  
y patas isabelinas

FR	PRECIO : 276	TELA CLIENTE	PRECIO : 223
RM	PRECIO : 276		PRECIO : 223

TAPA :							PRECIO: 588
PATAS :	<b>P-16</b>			PRECIO: 482			
PRECIO COMPLETA (120 cms. Ø) : 1.070							



CB CM OM OV CV

MESA CENTRO MOD. 62-50120RE (sólo C/200) - **RECICLADO ECOLÓGICO**  
120 x 120 x 37

MV PRECIO : 1.296

OPCIÓN CON PATAS DE MADERA MISMO PRECIO /  
SAME PRICE WITH WOOD LEGS OPTION

ESPEJO MOD. 68-62010  
100 Ø

M PRECIO : 362

MV PRECIO : 453

FR PRECIO : 391

RM PRECIO : 416

R PRECIO : 416

CONSOLA MOD. 63-58050  
130 x 30 x 80

M PRECIO : 750

MV PRECIO : 750

FR PRECIO : 750

RM PRECIO : 750

R PRECIO : 750

El casco siempre será en LCH  
y el cajón en la madera  
elegida.

The frame is made of LCH  
and the drawer is made of the  
chosen wood.



OM OV CV

MESA CENTRO MOD. 72-50120

M PRECIO : 1.115

RM PRECIO : 1.204

MV PRECIO : 1.231

R PRECIO : 1.204

FR PRECIO : 1.163



TAPA :					PRECIO : 944
PATAS :	<b>P-17C</b>		PRECIO : 630		
PRECIO COMPLETA (2x1): 1.574					

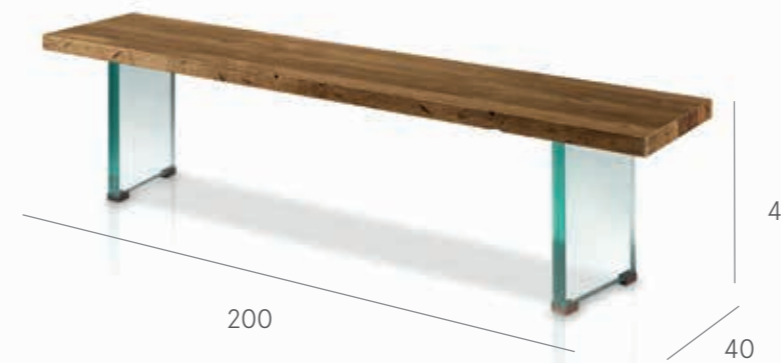

- BANCO PATAS CRISTAL MOD. 64-36200-2
- PRECIO : 638
  - PRECIO : 663
  - PRECIO : 682
  - PRECIO : 682





APARADOR CON VITRINA MOD. 64-09010

- CHAPA FR PRECIO : 2.622
- CHAPA RM PRECIO : 3.015
- CHAPA R PRECIO : 3.015

APARADOR MOD. 64-07010

- CHAPA FR PRECIO : 1.223
- CHAPA RM PRECIO : 1.406
- CHAPA R PRECIO : 1.406



CB CM OM OV CV (Patas Metal)

MESA CENTRO MOD. 68-50120  
120 x120 x 30

- M PRECIO : 840
- MV PRECIO : 1.050
- FR PRECIO : 924
- RM PRECIO : 997
- R PRECIO : 997



TAPA :		 <b>4,5</b> <small>Color unico</small>			PRECIO : 970
PATAS :	<b>P-2</b>			PRECIO : 992	
PRECIO COMPLETA (2x1): 1.962					





APARADOR MOD. 15-07020

- CHAPA FR PRECIO : 1.100
- CHAPA RM PRECIO : 1.265
- CHAPA R PRECIO : 1.265

TAPA :							PRECIO : 754
PATAS :	<b>P-3</b>			PRECIO : 632			
PRECIO COMPLETA (2x1): 1.386							



APARADOR MIXTO MOD. 58-07010

- M** PRECIO : 1.602
- MV** PRECIO : 1.922
- FR** PRECIO : 1.730
- RM** PRECIO : 1.842
- R** PRECIO : 1.842

El armazón en la madera que se elija, y los frentes de las puertas en macizo o chapa.

The frame of the chosen wood and the front of the doors of solid wood or veneer.



TAPA :		 4,5				PRECIO : 754
PATAS :	<b>P-3</b>			PRECIO : 551		
PRECIO COMPLETA (2x1): 1.305						

APARADOR MOD. 58-07010AR

- M** PRECIO : 1.745
- MV** PRECIO : 2.094
- FR** PRECIO : 1.884
- RM** PRECIO : 2.006
- R** PRECIO : 2.006

100% Macizo / 100% solid wood



TAPA :		 4,5				PRECIO : 754
PATAS :	<b>P-3</b>			PRECIO : 551		
PRECIO COMPLETA (2x1): 1.305						

TAPA :		 4,5				PRECIO : 754
PATAS :	<b>P-3</b>			PRECIO : 632		
PRECIO COMPLETA (2x1): 1.386						



VITRINA MOD. 39-11010

CHAPA	<b>FR</b>	PRECIO : 982
CHAPA	<b>RM</b>	PRECIO : 1.129
CHAPA	<b>R</b>	PRECIO : 1.129



VITRINA MOD. 39-11020

CHAPA	<b>FR</b>	PRECIO : 735
CHAPA	<b>RM</b>	PRECIO : 845
CHAPA	<b>R</b>	PRECIO : 845



APARADOR MOD. 15-07020

CHAPA	<b>FR</b>	PRECIO : 1.100
CHAPA	<b>RM</b>	PRECIO : 1.265
CHAPA	<b>R</b>	PRECIO : 1.265



SILLA MOD. 57-03010  
Silla Tapizada patas isabelinas  
TELA CLIENTE

<b>FR</b>	PRECIO : 221	PRECIO : 178
<b>RM</b>	PRECIO : 221	PRECIO : 178



TAPA :		4,5				PRECIO : 1.002
PATAS :	<b>P-3</b>			PRECIO : 551		
PRECIO COMPLETA (2x1): 1.553						

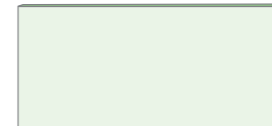

Cristal 8 mm opcional  
8mm Glass optional  
PRECIO 2X1 : 237

TAPA :		4,5				PRECIO : 1.002
PATAS :	<b>P-3</b>			PRECIO : 551		
PRECIO COMPLETA (2x1): 1.553						



SILLA MOD. **58-03030 (Mixta)**  
Silla medallón respaldo erosionado C/184  
TELA CLIENTE  
**FR** PRECIO : 312    PRECIO : 299  
**RM** PRECIO : 312    PRECIO : 299



VITRINA MIXTA MOD. **58-07030**  
**M** PRECIO : 2.128  
**MV** PRECIO : 2.553  
**FR** PRECIO : 2.298  
**RM** PRECIO : 2.447  
**R** PRECIO : 2.447

El armazón en la madera que se elija, y los frentes de las puertas en macizo o chapa.  
The frame of the chosen wood and the front of the doors of solid wood or veneer.

TAPA : PTA M 9 REC F2 185 PRECIO : 820

PATAS : P-3 MA 184 PRECIO : 551

PRECIO COMPLETA (2x1): 1.371

**Casanova**  
gandía



VITRINA MIXTA MOD. 58-11010

- M PRECIO : 1.392
- MV PRECIO : 1.670
- FR PRECIO : 1.503
- RM PRECIO : 1.601
- R PRECIO : 1.601

El armazón en la madera que se elija, y los frentes de las puertas en macizo o chapa.

The frame of the chosen wood and the front of the doors of solid wood or veneer.

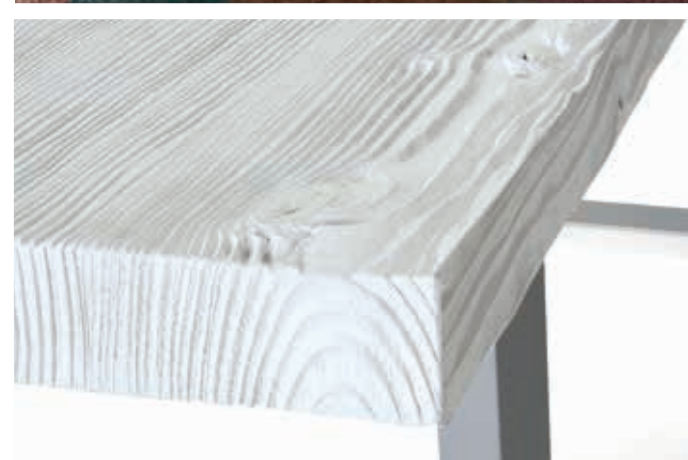

ESTANTERIA MOD. 58-64020

- M** PRECIO : 1.268
- MV** PRECIO : 1.521
- FR** PRECIO : 1.369
- RM** PRECIO : 1.458
- R** PRECIO : 1.458



ESTANTERIA MOD. 58-64010

- M** PRECIO : 948
- MV** PRECIO : 1.137
- FR** PRECIO : 1.023
- RM** PRECIO : 1.090
- R** PRECIO : 1.090

TAPA :	<b>E</b>	<b>M</b>	<b>9</b>	<b>REC</b>	<b>F2</b>	<b>185</b>	PRECIO : 1.066
--------	----------	----------	----------	------------	-----------	------------	----------------

PATAS :	<b>P-5</b>	<b>MA</b>	<b>185</b>	PRECIO : 317
---------	------------	-----------	------------	--------------

PRECIO COMPLETA (2x1): 1.383



Cristal 8 mm opcional  
8mm Glass optional  
PRECIO 2X1 : 237

MESA CENTRO PATAS MADERA MOD. 59-50020

- M** PRECIO : 702
- MV** PRECIO : 842
- FR** PRECIO : 758
- RM** PRECIO : 807
- R** PRECIO : 807
- LCH** PRECIO : 407 (Sólo lacas)









TAPA :							PRECIO : 1.066
PATAS :	<b>P-5</b>			PRECIO : 496			
PRECIO COMPLETA (2x1): 1.562							









155

VITRINA MOD. 15-11010

- CHAPA  PRECIO : 1.048
- CHAPA  PRECIO : 1.205
- CHAPA  PRECIO : 1.205

- 
- 
- 
- 
- 

MESA CENTRO PATAS METAL MOD. 59-50020-1

-  PRECIO : 898
-  PRECIO : 972
-  PRECIO : 997
-  PRECIO : 972
-  PRECIO : 937
-  PRECIO : 603 (Sólo lacas)



# Mesas completas la solución todo en uno.

I want this table! But I can choose a different size.



## Seis formas de combinar tu mesa...

Six options for creating your table...

**1** Tapa / Chapa (FR) + Estructura / Maciza (M)  
Chapa Fresno + Mobila

**2** Tapa / Chapa (FR) + Estructura / Maciza (FR)  
Chapa Fresno + Fresno

**3** Tapa / Chapa (RM) + Estructura / Maciza (RM)  
Chapa Roble Marinado + Roble Marinado

**4** Tapa / Chapa (R) + Estructura / Maciza (R)  
Chapa Roble + Roble

**5** Estructura y tapa / Maciza (M, FR, RM, R)  
Mobila, Fresno, Roble Marinado, Roble

**6** Estructura y tapa / Chapa (FR, RM, R)  
Chapa Fresno, Chapa Roble Marinado, Chapa Roble

## Distintos colores Other Colours

184 Embero Envejecido

69 Castaño

51 Avellana Envejecida

167 Decapé Ceniza

185 Blanco Encalado

65 Mediterráneo

200 Reciclado Ecológico

71 Wengué

182 Blanco Roto

Ral +10%

## Distintas chapas Other veneers

RM Chapa Roble Marinado  
Royal Oak Veneer

FR Chapa Fresno  
Ash Veneer

R Chapa Roble  
Oak Veneer



**APARADOR MOD. 58-07010AR**  
**M** PRECIO : 1.745  
**MV** PRECIO : 2.094  
**FR** PRECIO : 1.884  
**RM** PRECIO : 2.006  
**R** PRECIO : 2.006

100% Macizo / 100% solid wood



**OM** **OV** **CV**

**ESTANTERIA MOD. 70-64030**  
**M** PRECIO : 1.812  
**MV** PRECIO : 2.079  
**FR** PRECIO : 1.920  
**RM** PRECIO : 2.012  
**R** PRECIO : 2.012  
**LCH** PRECIO : 1.323 (Sólo lacas)

MESA COMEDOR MOD. 66-01002

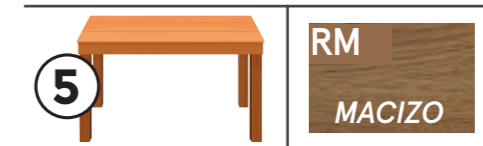

PRECIO COMPLETA (2x1): 1.606

**M** PRECIO M<sup>2</sup> : 698  
**MV** PRECIO M<sup>2</sup> : 837  
**FR** PRECIO M<sup>2</sup> : 754  
**RM** PRECIO M<sup>2</sup> : 803  
**R** PRECIO M<sup>2</sup> : 803

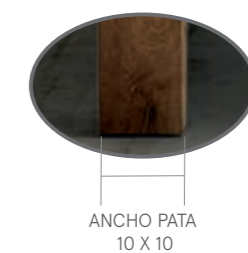

ANCHO PATA  
10 X 10



ANCHO PATA 20 X 20

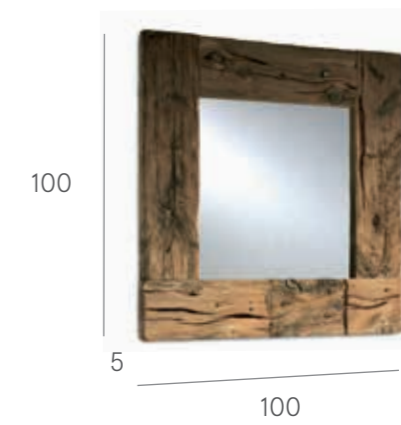

MESA COMEDOR MOD. 62-02200

5		M MACIZO	167

- M PRECIO M<sup>2</sup> : 1.031
- MV PRECIO M<sup>2</sup> : 1.237
- FR PRECIO M<sup>2</sup> : 1.113
- RM PRECIO M<sup>2</sup> : 1.186
- R PRECIO M<sup>2</sup> : 1.186



ASIENTO TRONCO MOD. 65-06010  
PRECIO : 145



ESPEJO MOD. 62-62010RE

- M PRECIO : 450
- MV PRECIO : 490
- FR PRECIO : 470
- RM PRECIO : 480
- R PRECIO : 480

APARADOR MOD. 27-07020

- CHAPA FR PRECIO : 1.520
- CHAPA RM PRECIO : 1.520
- CHAPA R PRECIO : 1.520

En el aparador la opción RM y R, será toda la pieza en el mismo material elegido.

Same material for the buffet in the options Royal Oak and Oak.



VITRINA MIXTO MOD. 58-09010

M	PRECIO : 1.569	RM	PRECIO : 1.804
MV	PRECIO : 1.883	R	PRECIO : 1.804
FR	PRECIO : 1.694		

El armazón en la madera que se elija, y los frentes de las puertas y cajones en macizo o chapa.

The frame of the chosen wood and the front of the doors of solid wood or veneer.



SILLA MOD. 27-03010

Silla Tapizada pata recta

		TELA CLIENTE
FR	PRECIO : 218	PRECIO : 173
RM	PRECIO : 218	PRECIO : 173

MESA COMEDOR - Opción 1

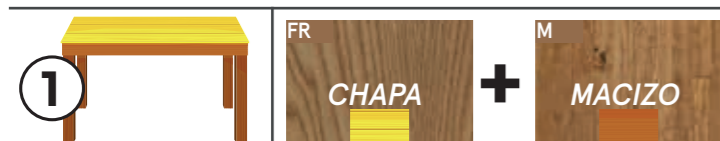

Ref.: 58-01040	140 x 95 x 78 - Ext. 200	PRECIO : 812
Ref.: 58-01060	160 x 95 x 78 - Ext. 220	PRECIO : 851
Ref.: 58-01080	180 x 95 x 78 - Ext. 240	PRECIO : 889

167

Opción 2

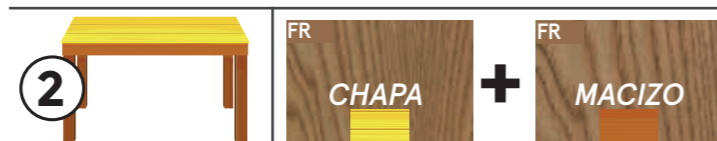

Ref.: 58-01040	140 x 95 x 78 - Ext. 200	PRECIO : 876
Ref.: 58-01060	160 x 95 x 78 - Ext. 220	PRECIO : 919
Ref.: 58-01080	180 x 95 x 78 - Ext. 240	PRECIO : 960

167

Opción 3

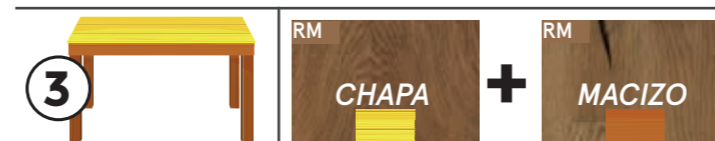

Ref.: 58-01040	140 x 95 x 78 - Ext. 200	PRECIO : 933
Ref.: 58-01060	160 x 95 x 78 - Ext. 220	PRECIO : 978
Ref.: 58-01080	180 x 95 x 78 - Ext. 240	PRECIO : 1.022

167

Opción 4

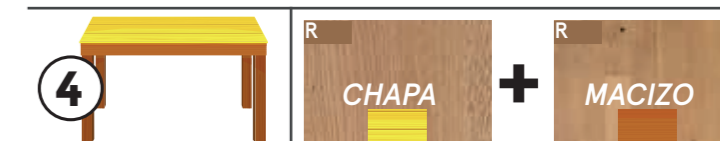

Ref.: 58-01040	140 x 95 x 78 - Ext. 200	PRECIO : 933
Ref.: 58-01060	160 x 95 x 78 - Ext. 220	PRECIO : 978
Ref.: 58-01080	180 x 95 x 78 - Ext. 240	PRECIO : 1.022

167



SILLA MOD. **27-03010**  
 Silla Tapizada pata recta  
 TELA CLIENTE  
**FR** PRECIO : 218    PRECIO : 173  
**RM** PRECIO : 218    PRECIO : 173



APARADOR MOD. **39-07010TR**  
**CHAPA FR** PRECIO : 1.130  
**CHAPA RM** PRECIO : 1.299  
**CHAPA R** PRECIO : 1.299



VITRINA MOD. **39-09010**  
**CHAPA FR** PRECIO : 1.219  
**CHAPA RM** PRECIO : 1.401  
**CHAPA R** PRECIO : 1.401

Mesa Comedor - Chapa Fresno



Ref.: **39-01040** 140 x 90 x 76 - Ext. 210 ·PRECIO : 902  
 Ref.: **39-01060** 160 x 90 x 76 - Ext. 230 ·PRECIO : 945

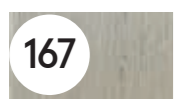

Mesa Comedor - Chapa Roble Marinado

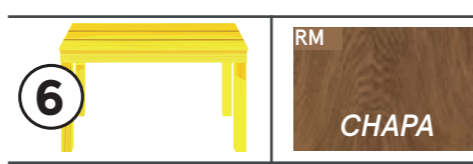

Ref.: **39-01040** 140 x 90 x 76 - Ext. 210 ·PRECIO : 1.037  
 Ref.: **39-01060** 160 x 90 x 76 - Ext. 230 ·PRECIO : 1.086

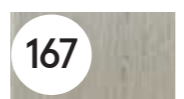

Mesa Comedor - Chapa Roble

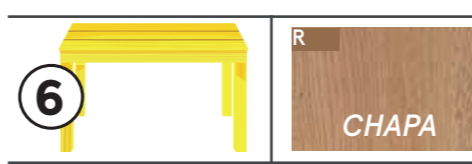

Ref.: **39-01040** 140 x 90 x 76 - Ext. 210 ·PRECIO : 1.037  
 Ref.: **39-01060** 160 x 90 x 76 - Ext. 230 ·PRECIO : 1.086





VITRINA MOD. 39-09020

- CHAPA FR PRECIO : 1.186
- CHAPA RM PRECIO : 1.363
- CHAPA R PRECIO : 1.363

**Casanova  
gandia**

Mesa Comedor - Opción 2

<b>2</b>		<span style="background-color: #8B4513; color: white; padding: 0 2px;">FR</span> CHAPA	+	<span style="background-color: #8B4513; color: white; padding: 0 2px;">FR</span> MACIZO
Ref.: <b>45-01041</b> 140 x 90 x 76 - Ext. 200 ·PRECIO : 1.163				
Ref.: <b>45-01061</b> 160 x 90 x 76 - Ext. 220 ·PRECIO : 1.212				

185 CB CM OM OV CV

Opción 3

<b>3</b>		<span style="background-color: #8B4513; color: white; padding: 0 2px;">RM</span> CHAPA	+	<span style="background-color: #8B4513; color: white; padding: 0 2px;">RM</span> MACIZO
Ref.: <b>45-01041</b> 140 x 90 x 76 - Ext. 200 ·PRECIO : 1.337				
Ref.: <b>45-01061</b> 160 x 90 x 76 - Ext. 220 ·PRECIO : 1.393				

185 CB CM OM OV CV

Opción 4

<b>4</b>		<span style="background-color: #8B4513; color: white; padding: 0 2px;">R</span> CHAPA	+	<span style="background-color: #8B4513; color: white; padding: 0 2px;">R</span> MACIZO
Ref.: <b>45-01041</b> 140 x 90 x 76 - Ext. 200 ·PRECIO : 1.337				
Ref.: <b>45-01061</b> 160 x 90 x 76 - Ext. 220 ·PRECIO : 1.393				

185 CB CM OM OV CV



SILLA MOD. 57-03010  
 Silla Tapizada patas isabelinas  
 TELA CLIENTE  
 FR PRECIO : 221    PRECIO : 178  
 RM PRECIO : 221    PRECIO : 178



VITRINA MOD. 15-09010  
 CHAPA FR PRECIO : 1.255  
 CHAPA RM PRECIO : 1.443  
 CHAPA R PRECIO : 1.443



APARADOR MOD. 15-07010  
 CHAPA FR PRECIO : 1.345  
 CHAPA RM PRECIO : 1.546  
 CHAPA R PRECIO : 1.546

Mesa Comedor - Chapa Fresno



Ref.: 15-01040 140 x 95 x 78 - Ext. 200 ·PRECIO : 827  
 Ref.: 15-01060 160 x 95 x 78 - Ext. 220 ·PRECIO : 856

184

Mesa Comedor - Chapa Roble Marinado

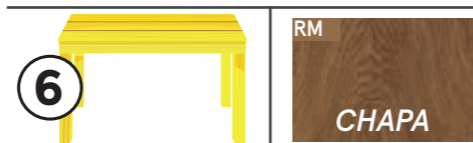

Ref.: 15-01040 140 x 95 x 78 - Ext. 200 ·PRECIO : 951  
 Ref.: 15-01060 160 x 95 x 78 - Ext. 220 ·PRECIO : 985

184

Mesa Comedor - Chapa Roble

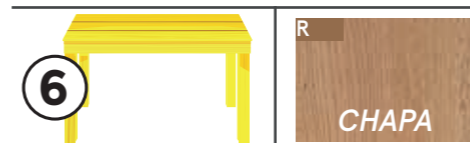

Ref.: 15-01040 140 x 95 x 78 - Ext. 200 ·PRECIO : 951  
 Ref.: 15-01060 160 x 95 x 78 - Ext. 220 ·PRECIO : 985

184





**Casanova  
gandia**

Mesa Comedor - Chapa Fresno



Ref.: **45-01040** 140 x 90 x 76 - Ext. 200 ·PRECIO : **848**

Ref.: **45-01060** 160 x 90 x 76 - Ext. 220 ·PRECIO : **896**



Mesa Comedor - Chapa Roble Marinado

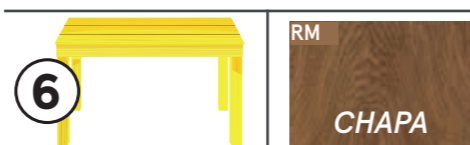

Ref.: **45-01040** 140 x 90 x 76 - Ext. 200 ·PRECIO : **975**

Ref.: **45-01060** 160 x 90 x 76 - Ext. 220 ·PRECIO : **1.030**



Mesa Comedor - Chapa Roble

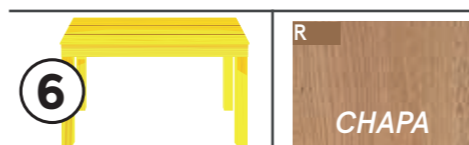

Ref.: **45-01040** 140 x 90 x 76 - Ext. 200 ·PRECIO : **975**

Ref.: **45-01060** 160 x 90 x 76 - Ext. 220 ·PRECIO : **1.030**



APARADOR MOD. **39-07020TR**

CHAPA **FR** PRECIO : **1.007**  
 CHAPA **RM** PRECIO : **1.158**  
 CHAPA **R** PRECIO : **1.158**