

# Il senso dei dettagli

A SENSE OF DETAIL

COMPLEMENTS

Alf DaFrè®



**Alf DaFrè®**

# Il piacere di arredare tutta la casa, in armonia con il proprio stile di vita

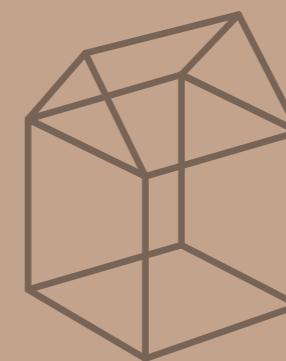

The delight in furnishing  
your entire home in keeping  
with your own personal  
lifestyle

El placer de amueblar todo  
tu hogar, en armonía con tu  
estilo de vida

Le plaisir de décorer toute  
la maison, en harmonie  
avec son propre style de vie

Einrichtungslösungen für  
das ganze Haus – passend  
zu Ihrem Lebensstil

Удовольствие выбора  
интерьера для собственного  
дома, в соответствии с  
собственным стилем жизни

# PRODOTTI

Products

- 1 DIVANI/POLTRONE/POUF**  
sofas/armchairs/pouf  
sofás/sillones/puffs  
canapés/fauteuils/poufs  
Sofas/Armlehnstühle/Polsterhocker  
диваны/кресла/пуфы
- 2 TAVOLI/TAVOLINI**  
tables/occasional tables  
mesas/mesitas  
tables/tables basses  
Tische/Beistelltische  
столы/столики
- 3 SEDIE**  
chairs  
sillas  
chaises  
Stühle  
стулья
- 4 LIBRERIE**  
bookcases  
librerías  
bibliothèques  
Bücherregale/книжные шкафы

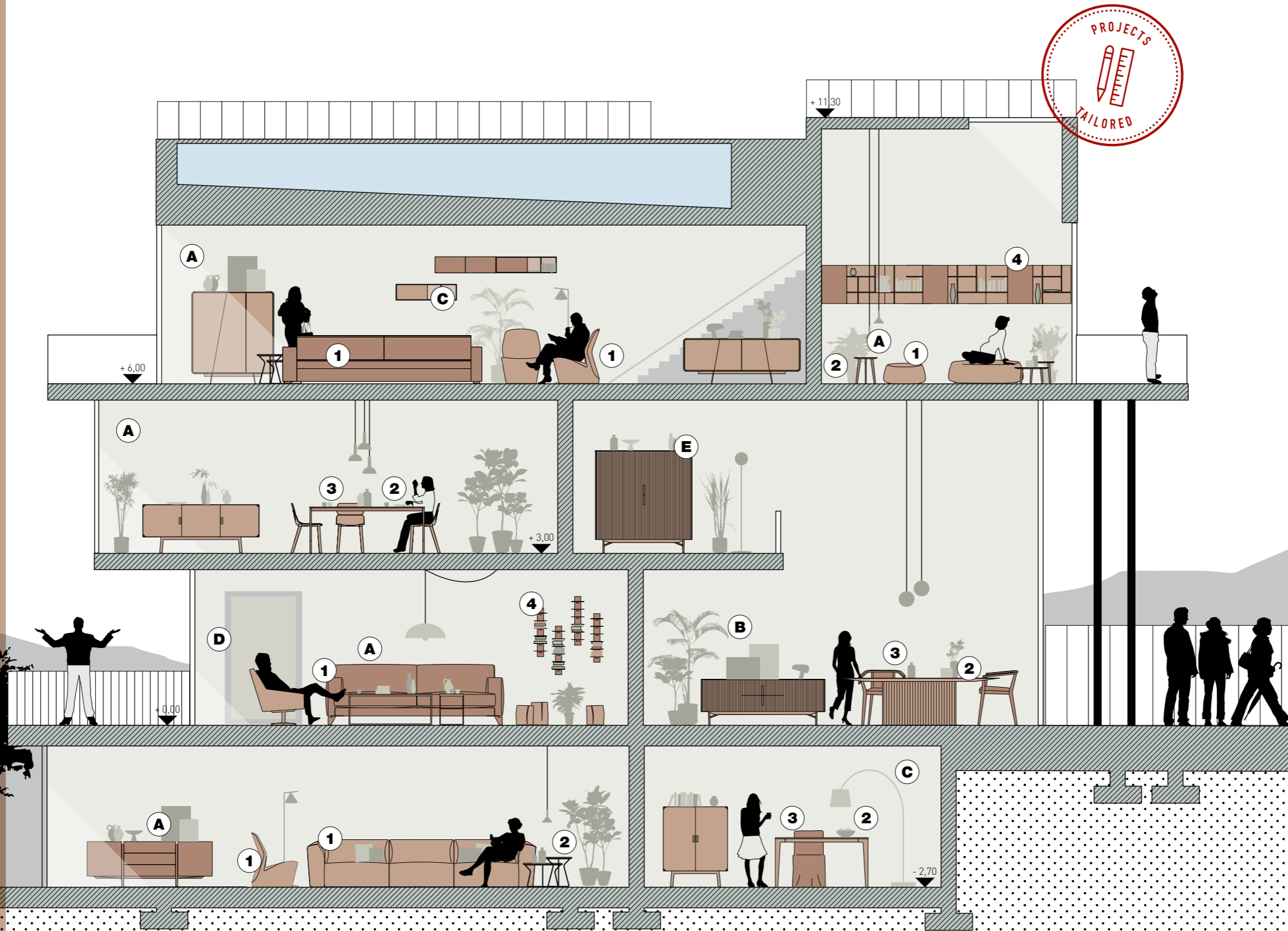

# AMBIENTI

Rooms

- A SOGGIORNO**  
living room  
salón  
séjour  
Wohnzimmer  
гостиная
- B ZONA PRANZO**  
dining room  
comedor  
zone repas  
Esszimmer  
столовая
- C STUDIO**  
study  
estudio  
bureau  
Arbeitszimmer  
кабинет
- D INGRESSO**  
entrance hall  
entrada  
entrée  
Eingang  
прихожая
- E CORRIDOIO**  
corridor  
pasillo  
couloir  
Gang  
коридор

## divani poltrone pouf

sofas  
armchairs pouf

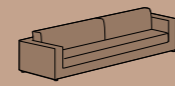

**California**  
pag. 008



**Denny**  
pag. 070

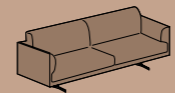

**Copenhagen**  
pag. 020



**Jet Set**  
pag. 078

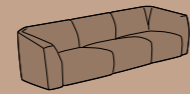

**Ladigue**  
pag. 028



**Odette**  
pag. 082

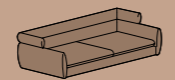

**Oregon**  
pag. 042



**Olivia**  
pag. 088

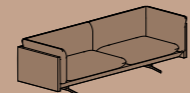

**Oslo**  
pag. 050

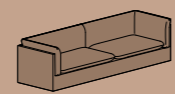

**Stoccolma**  
pag. 056

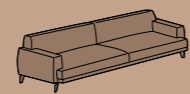

**Utah**  
pag. 062

## tavolini tavoli

occasional tables  
tables



**Air**  
pag. 098



**Ceppo**  
pag. 104



**Kobe**  
pag. 108



**Life**  
pag. 116



**Moca**  
pag. 120

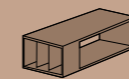

**Norman**  
pag. 126



**Rim**  
pag. 134



**Tuft**  
pag. 140



**Wok**  
pag. 146



**Wok Box**  
pag. 146

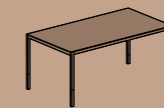

**Aliante**  
pag. 154



**Board**  
pag. 162

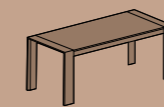

**Brera 2.0 / Brera Lux**  
pag. 172



**Cartesio 2.0**  
pag. 178



**Cliff**  
pag. 186



**Jag**  
pag. 192



**Le 20**  
pag. 208

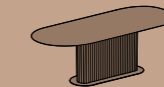

**Rigadin**  
pag. 292



**Aileron**  
pag. 216



**Corium**  
pag. 222



**Electa**  
pag. 230



**Esedra**  
pag. 234



**Karina**  
pag. 240



**Karol / Karol Wood**  
pag. 246



**Viky**  
pag. 254

## accessori librerie

accessories  
bookcases



**Domino**  
pag. 262



**Free, Pod**  
pag. 268



**Press**  
pag. 274

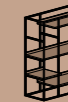

**Up**  
pag. 278



**Versus**  
pag. 282



**Haiku / Haiku Servomoto**  
pag. 286

## CALIFORNIA

design Enrico Cesana

California è un divano dalle forme regolari e dalla vasta modularità. Ampiamente componibile soddisfa le più svariate esigenze nella zona living grazie alle molteplici librerie in legno. Sono disponibili inoltre piedi in legno.

California is a regular-shaped sofa affording maximum modularity. Extensively modular, it accommodates the most diverse living room needs, thanks to the multiple wooden bookcases. Wooden feet are also available.

California es un sofá de formas regulares y amplias posibilidades modulares. Al ofrecer una gran libertad de composición, satisface las necesidades más variadas de la zona de estar, gracias a las múltiples librerías de madera. También están disponibles las patas de madera.

California est un canapé aux formes régulières et d'une vaste modularité. Amplement modulable il satisfait les plus différentes exigences dans la zone living grâce aux multiples bibliothèques en bois. Des pieds en bois sont en outre disponibles.

California ist ein flexibles und modulares Sofa mit geraden Linien. Die flexiblen Kombinationsmöglichkeiten passen sich den unterschiedlichsten Anforderungen im Wohnbereich an. Die zahlreichen Holzregale sind dabei die perfekte Ergänzung. Auch mit Holzfüßen erhältlich.

California - диван правильных форм, характеризующийся обширной модульностью. Большой выбор компоновочных решений может удовлетворить различные требования зоны гостиной, благодаря использованию многочисленных деревянных книжных шкафов. Кроме того, предусмотрены деревянные ножки.

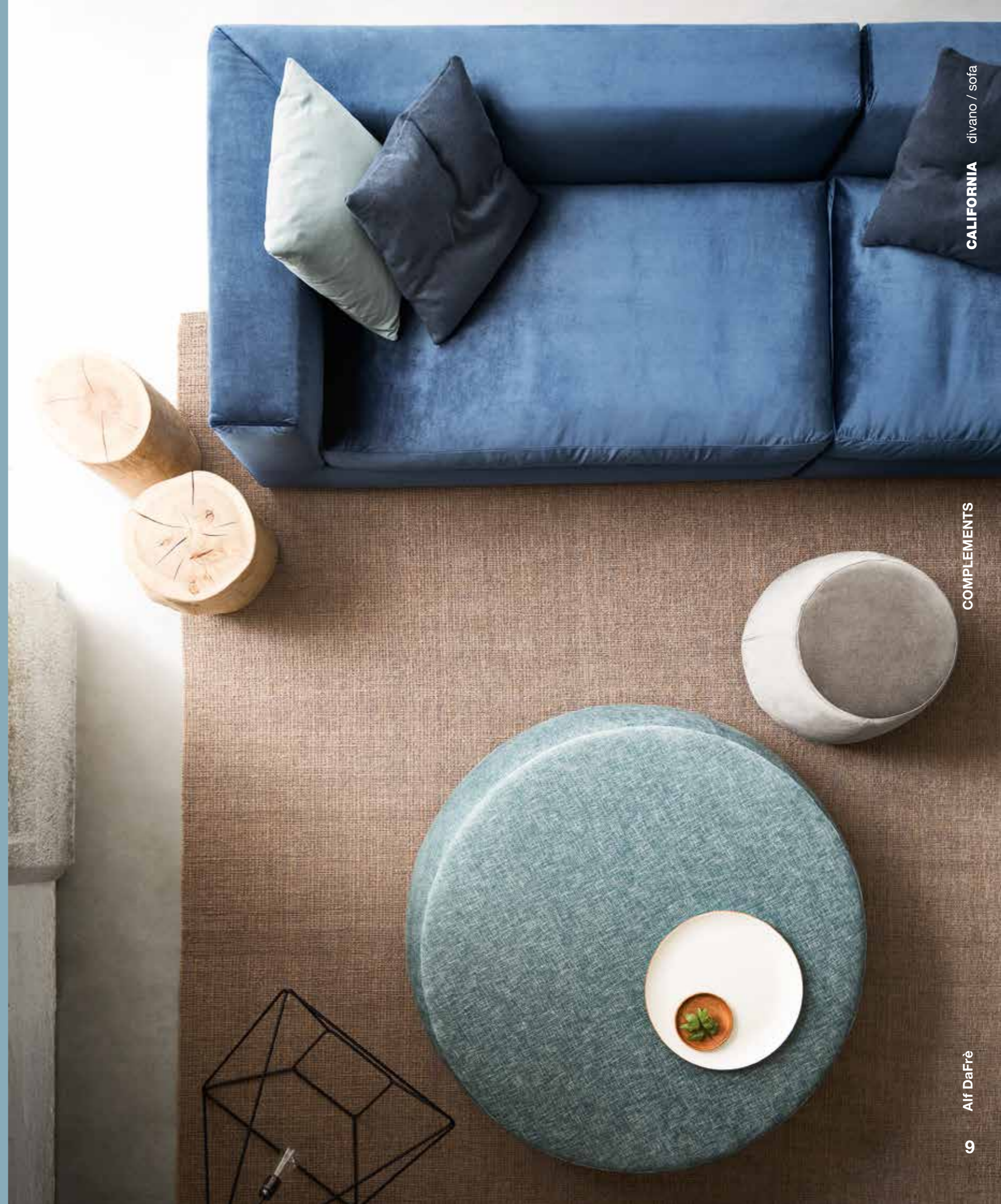

**RECTA** madia / cabinets  
Laccato Juta opaco / Matt Juta lacquered L167 P49 H160,5  
**NORMAN** tavolino / occasional table  
Rovere laccato opaco Platino, laccato Platino lucido /  
Matt laquered oak Platino, High gloss Platino lacquered L120 P70 H33,6  
**DENNY** pouf / pouf  
Tessuto Zeph 01 / Zeph 01 fabric L55 P55 H42  
**DENNY** pouf / pouf  
Tessuto Tennessee 11 / Tennessee 11 fabric L85 P85 H37  
**CALIFORNIA** divano / sofa  
Tessuto Zeph 12 / Zeph 12 fabric L316 P100 H84





**CALIFORNIA** divano / sofa  
Tessuto Wonderful 02 / Wonderful 02 fabric L438 P338 H84  
**NORMAN** tavolino / occasional table  
Laccato Arena opaco / Matt Arena lacquered L100 P100 H33,6  
**NORMAN** tavolino / occasional table  
Laccato Cipria opaco / Matt Cipria lacquered L120 P70 H33,6  
**TUFT** tavolino / occasional table  
Laccato Ghisa opaco / Matt Ghisa lacquered L60,3 P60,3 H36,8  
**MY SPACE** libreria / bookcase  
Per questo articolo vedi "MY SPACE" spazio alle emozioni /  
For this article see "MY SPACE" space to emotions



**CALIFORNIA** divano / sofa  
 Tessuto Ranger 01, bracciolo e schienali Fashion wood Rovere Carbone /  
 Ranger 01 fabric, arm and back panels in Carbone oak Fashion wood L448 P372 H84  
**RECTA** libreria / bookcase  
 Laccato Ghisa opaco, Fashion wood Rovere Carbone /  
 Matt Ghisa lacquered, Carbone oak Fashion wood L75 P80 H7  
**KOBE** tavolino / occasional table  
 Struttura Carta da zucchero opaco, Fashion wood Rovere Carbone /  
 Matt Carta da zucchero lacquered, Carbone oak Fashion wood L90 P90 H33

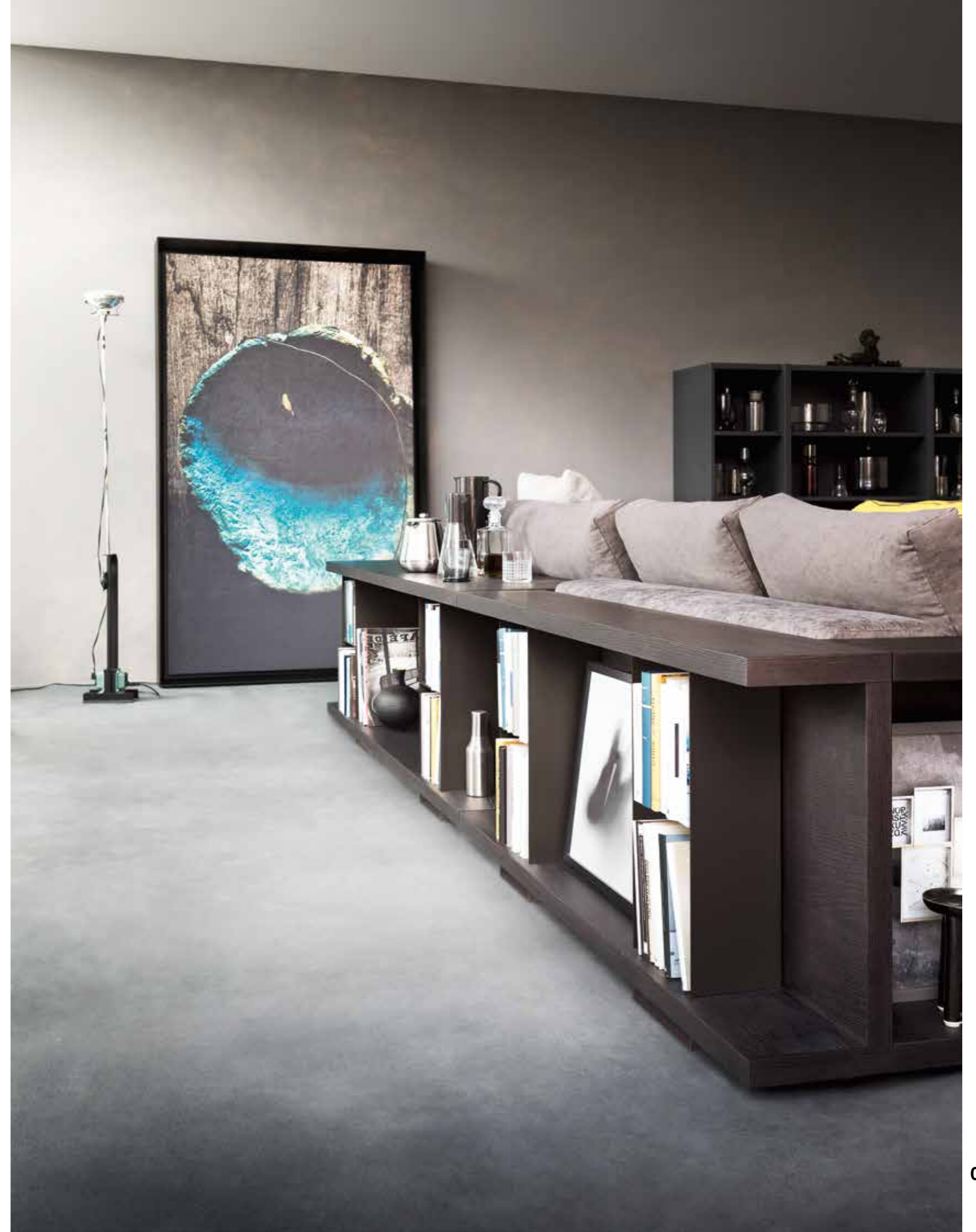

Rivestimento:  
Tessuti / Pelle / Ecopelle  
Piedini:  
Colori opachi / Rovere  
termocotto / Rovere colori  
opachi / Fashion wood /  
Colori lucidi

Covering:  
Fabric / Leather /  
Ecoleather  
Feet (optional):  
Matt colours / Baked  
oak / Oak matt colours /  
Fashion wood / High gloss  
colours

Revestimiento:  
Tejidos / Piel / Eco-piel  
Patas (opcionales):  
Colores mate / Roble  
termotratado / Roble  
teñido colores mate /  
Fashion wood /Colores  
brillantes

Revêtement :  
Tissus / Cuir / Éco-cuir  
Pieds (option) :  
Laqués mats /Chêne  
thermo-traité / Chêne  
laqué mat / Fashion wood  
/Laqués brillants

Bezug:  
Stoff / Leder / Kunstleder  
Füße (optional):  
Matte Farben / Thermo-  
Eiche / Eiche matte  
Farben / Fashion Wood /  
glänzende Farben

Обивка:  
Ткань / Кожа / Экокожа  
Ножки  
(дополнительные):  
Матовые цвета /  
Дуб термोकотто /  
Дуб матовых цветов  
/ Fashion wood /  
Глянцевые цвета

Esempi di composizioni con cuscini schienale  
Composition examples with seat back cushions /  
Ejemplos de composiciones con cojines de respaldo /  
Exemples de compositions avec coussins du dossier /  
Beispiele für Zusammenstellungen mit Rückenkissen /  
Примеры композиций с подушками спинки



**Divani**  
Sofas / Sofás / Canapés / Sofas / Диваны

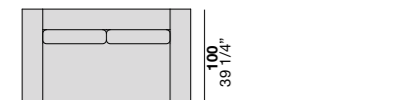
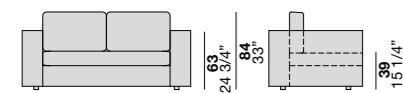

158 / 180 / 202 / 224 / 246  
62 1/4" 70 3/4" 79 1/2"  
88 1/4" 96 3/4"

**Moduli terminali sx o dx**  
LH or RH end units / Módulos terminales izda. o dcha. / Modules terminaux gauches ou droites / Abschlusselemente li. oder re. / Терминальные лев. или прав. модули

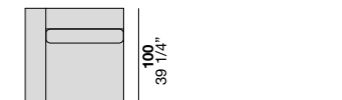

92 / 136 / 158 / 180 / 202 / 224  
36 1/4" 53 1/2" 32 1/4"  
70" 3/4" 79 1/2" 88 1/4"

**Moduli centrali**  
Central units / Módulos centrales / Modules centraux / Mittelelemente / Центральные модули

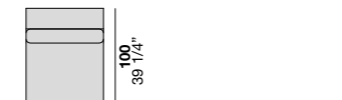
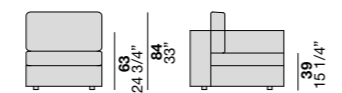

70 / 114 / 136 / 158 / 180 / 202  
27 1/2" 44 3/4" 53 1/2"  
62 1/4" 70 3/4" 79 1/2"

**Schienali**  
Seat backs / Paneles de pared / Dossiers / Rückwände / Задние стенки



70 / 92 / 114 / 136  
27 1/2" 36 1/4"  
44 3/4" 53 1/2"

**Moduli centrali senza schienale**  
Central units without seat back / Módulos centrales sin respaldo / Modules centraux sans dossier / Mittelelemente ohne Rückwände / Центральные модули без спинки

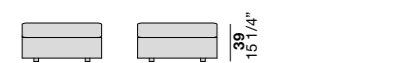

70 / 114 / 136  
158 / 180 / 202  
27 1/2" 44 3/4"  
53 1/2" 62 1/4"  
70 3/4" 79 1/2"

**Chaise longue sx o dx**  
LH or RH chaise longue / Chaise longue izda. o dcha. / Chaise longue gauche ou droite / Chaiselongue li. oder re. / Лев. или прав. шезлонги

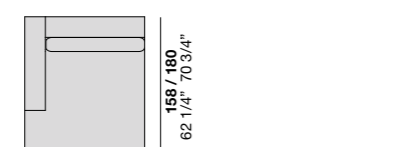

92 / 136  
36 1/4" 53 1/2"

**Chaise longue simmetriche**  
Symmetrical chaises longues / Chaises longues simétricas / Chaises longues symétriques / Symmetrische Chaiselongue / Симметричные шезлонги

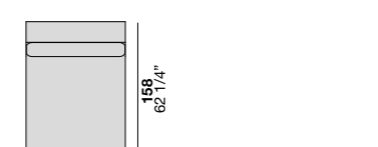
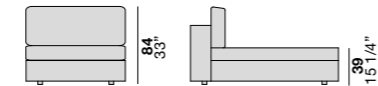

114 / 136  
44 3/4" 53 1/2"

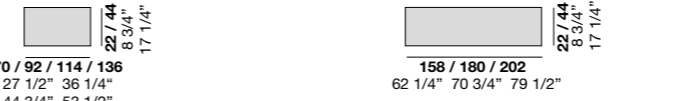

70 / 92 / 114 / 136  
27 1/2" 36 1/4"  
44 3/4" 53 1/2"

**Braccioli**  
Armrests / Reposas-brazos / Accoudoirs / Armlehnen / Подлокотники

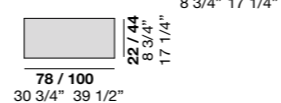
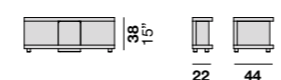

78 / 100  
30 3/4" 39 1/2"

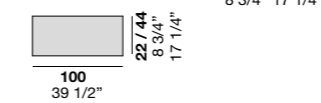
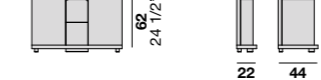

100  
39 1/2"

**Penisole sx o dx**  
LH or RH lounge units / Penínsulas izda o dcha. / Péninsules gauches ou droites / Liege-Inseln li. oder re. / Лев. или прав. полуостровные конструкции

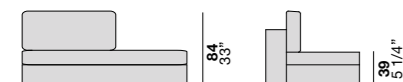

158 / 180 / 202  
62 1/4" 70 3/4" 79 1/2"



202 / 224  
79 1/2" 88 1/4"

**Poltrone**  
Armchairs / Sillones / Fauteuil / Armlehnstühle / Кресла

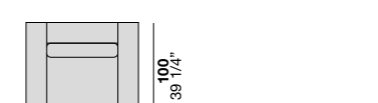
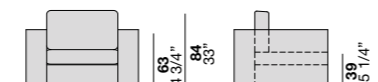

114  
44 3/4"

**Penisole terminali sx o dx**  
LH or RH end lounge units / Penínsulas terminales izda. o dcha. / Péninsules terminales gauches ou droites / Liege-Inseln, Abschlusselemente li. oder re. / Терминальные лев. или прав. полуостровные конструкции

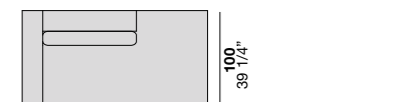
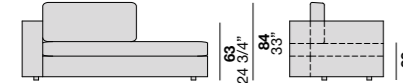

202  
79 1/2"

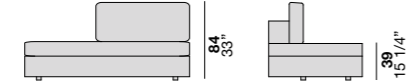

180 / 202  
70 3/4" 79 1/2"

**Pouf**  
Pouf / Puffs / Pouf / Polsterhocker / Пуфы

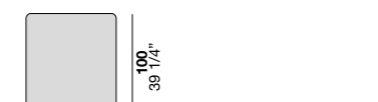
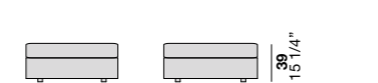

92  
36 1/4"

Il divano California è disponibile anche con schienali reclinabili per una seduta più confortevole e rilassante. In questa versione il divano è dotato di meccanismo interno che permette ad una o due sezioni dello schienale un movimento di circa 13 cm verso l'alto e una inclinazione di circa 6 gradi. Questa opzione è disponibile per poltrona, chaise longue e divano larghezza 158 cm (con uno schienale reclinabile), per divano nelle larghezze 202, 224 e 246 cm (con 2 schienali reclinabili).

The California sofa is also available with a reclining seat back for a more comfortable and relaxing seating position. In this version, the sofa is fitted with an internal mechanism that allows one or two sections of the seat back to move upwards by approximately 13 cm and to tilt by approximately 6 degrees. This option is available for the armchair, chaise longue and 158 cm wide sofa (with a reclining seat back), for 202, 224 and 246 cm wide sofas (with 2 reclining seat backs).

El sofá California también está disponible con respaldos reclinables, para sentarse en una postura más cómoda y relajada. En esta versión, el sofá incluye un mecanismo interno gracias al cual una o dos secciones del respaldo pueden moverse unos 13 cm hacia arriba e inclinarse unos 6 grados. Esta opción está disponible para sillón, chaise longue y sofá de 158 cm de ancho (con un respaldo reclinable), y para sofá de 202, 224 y 246 cm de ancho (con 2 respaldos reclinables).

Le canapé California est également disponible avec dossiers inclinables pour une assise plus confortable et relaxante. Dans cette version, le canapé est équipé d'un mécanisme interne permettant à une ou deux sections du dossier un mouvement d'environ 13 cm vers le haut et une inclinaison d'environ 6 degrés. Cette option est disponible pour fauteuil, chaise longue et canapé de 158 cm de largeur (avec un dossier inclinable), pour canapé de 202, 224 et 246 cm de largeur (avec 2 dossiers inclinables).

Das Sofa California ist auch mit verstellbarer Rückenlehne für eine bequeme und entspannende Sitzposition erhältlich. Bei dieser Version sorgt ein innenliegender Mechanismus dafür, dass ein oder zwei Elemente der Rückenlehne etwa 13 cm nach oben bewegt und ca. 6 Grad nach hinten geneigt werden können. Diese Option ist für Armlehnstühle, Chaiselongue und Sofas mit der Breite von 158 cm (mit einer verstellbaren Rückenlehne), für Sofas mit der Breite von 202, 224 und 246 cm (mit 2 verstellbaren Rückenlehnen) erhältlich.

Диван California также предусмотрен с наклоняемой спинкой в целях создания более удобного и комфортабельного сиденья. В данном варианте диван оснащен внутренним механизмом, обеспечивающим одной или двум секциям спинки движение приблизительно на 13 см вверх и наклон приблизительно на 6 градусов. Данная опция предусмотрена для кресла, шезлонга и дивана шириной 150 см (с одной наклоняемой спинкой), для дивана шириной 200, 220 и 240 см (с 2 наклоняемыми спинками).

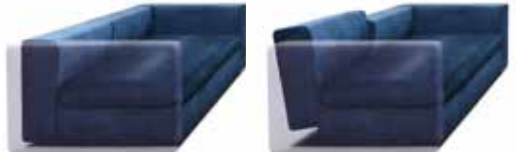
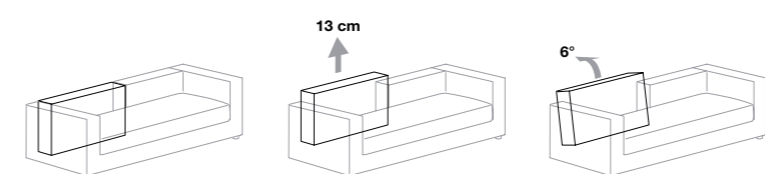

## COPENAGHEN

design Enrico Cesana

Copenaghen, l'idea quella di un prodotto sincero, di dimensioni contenute ma in gradi di accoglierci con grande comfort e rispondere a tutte le necessità della vita quotidiana. Leggero, lineare e visivamente composto per un abitare contemporaneo. Disponibile in cinque larghezze e in versione poltrona.

Copenhagen: the idea is to create an authentic product that is compact in size but still able to offer great levels of comfort, and respond to all of our everyday needs. Light, linear and ordered, for contemporary living. Available in five widths and as an armchair.

Copenaghen transmite la idea de un producto sincero, de tamaño compacto pero capaz de acogernos con un gran confort y satisfacer todas las necesidades de la vida cotidiana. Ligero, lineal y con una composición visual perfecta para la vivienda moderna. Disponible en cinco anchos y en versión sillón.

Copenaghen, l'idée est celle d'un produit sincère, aux dimensions contenues mais en mesure de nous accueillir avec un grand confort et de répondre à toutes les nécessités de la vie quotidienne. Léger, linéaire et visuellement composé pour une habitation contemporaine. Disponible en cinq largeurs et dans la version fauteuil.

Copenaghen: ein authentisches Produkt, kompakt aber gemütlich, das viel Komfort für alle in den Alltag bringt. Leicht, geradlinig - ein modernes Design, ideal für das Wohnen von heute. In fünf Breiten und als Sessel erhältlich.

Copenaghen - идея заключается в том, чтобы получить элемент мебели небольших размеров, но способный принять нас с большим комфортом и удовлетворить все потребности повседневной жизни. Легкий, с прямолинейными формами и компоновкой, визуально соответствующей современному стилю жизни. Предлагается пять различных вариантов ширины, а также вариант кресла.



**COPENAGHEN** divano / sofa  
Tessuto Salò 05 / Salò 05 fabric L260 P91 H86  
**MOCA** tavolino / occasional table  
Struttura laccato Ghisa opaco, piano Fashion wood Rovere Terra /  
Structure in Matt Ghisa lacquered, top in Terra oak Fashion wood L60 P60 H45,4  
**WOK** tavolino / occasional table  
Laccato Anfora opaco / Matt Anfora lacquered L27,5 P27,5 H50  
**KOBE** tavolino / occasional table  
Struttura laccato Platino opaco, piano Ceramica Limestone ash /  
Structure in Matt Platino lacquered, top in Ceramic Limestone ash L120 P70 H33  
**AIR** tavolino / occasional table  
Fashion wood Rovere Fossile /  
Fossile oak Fashion wood L55 P45 H42





**COPENAGHEN** divano / sofa  
 Tessuto Trento 04, Pelle Alfa 4270 /  
 Trento 04 fabric, Alfa 4270 leather L260 P91 H86  
**WOK** tavolino / occasional table  
 Laccato Anfora opaco /  
 Matt Anfora lacquered L27,5 P27,5 H50  
**MOCA** tavolino / occasional table  
 Struttura laccato Ghisa opaco,  
 piano Fashion wood Rovere Terra /  
 Structure in Matt Ghisa lacquered,  
 top in Terra oak Fashion wood L60 P60 H45,4  
**MOCA** tavolino / occasional table  
 Laccato Modica opaco /  
 Matt Modica lacquered L90 P90 H37  
**TUFT** tavolino / occasional table  
 Struttura verniciato Rame brunito,  
 piano Fashion wood Rovere Terra /  
 Structure in Rame brunito painted,  
 top in Terra oak Fashion wood L40,3 P40,3 H46,3





# Copenhagen

design **Enrico Cesana**

**Rivestimento:**  
Tessuti / Pelle / Ecopelle  
**Piedini:**  
Verniciato moka shine /  
Verniciato rame brunito

**Covering:**  
Fabric / Leather / Ecoleather  
**Feet:**  
Moka shine painted / rame  
brunito painted

**Revestimiento:**  
Tejidos / Piel / Eco-piel  
**Patas:**  
Barnizado moka shine /  
Barnizado rame brunito

**Revêtement :**  
Tissus / Cuir / Éco-cuir  
**Pieds :**  
Verni moka shine / Verni  
rame brunito

**Bezug:**  
Stoff / Leder / Kunstleder  
**FüÙe:**  
lackiertes Moka shine /  
Brüniertes und lackiertes  
Kupfer

**Обивка:**  
Ткань / Кожа / Экокожа  
**Ножки:**  
Крашеный мoka shine /  
Крашеный rame brunito

**Divani**  
Sofas / Sofás / Canapés / Sofas / Диваны

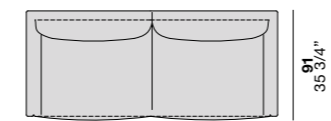
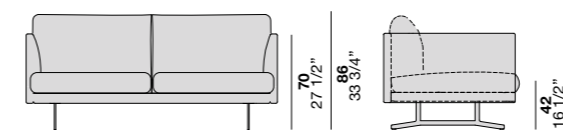

**180 / 200 / 220 / 240 / 260**  
70 3/4" 78 3/4" 86 1/2" 94 1/2" 102 1/4"

**Divani con cuscini decorativi**  
Sofas / Sofás / Canapés / Sofas / Диваны

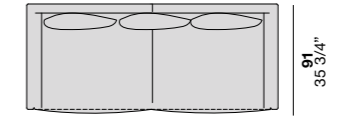
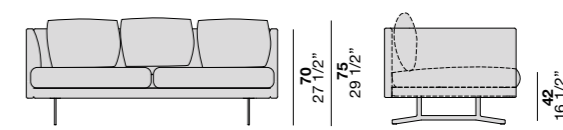

**180 / 200 / 220 / 240 / 260**  
70 3/4" 78 3/4" 86 1/2" 94 1/2" 102 1/4"

**Poltrona**  
Armchair / Sillón / Fauteuil / Armlehnstuhl / Кресло

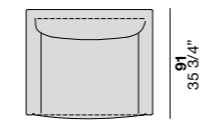
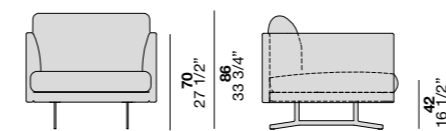

**90**  
35 1/2"



## LADIGUE

design Enrico Cesana

Ladigue è un divano componibile dallo stile soft e dall'aspetto morbido ed accogliente. Un design valorizzato da pence e morbide pieghe. È possibile trasformare la profondità della seduta a proprio piacimento con un semplice gesto; una seduta "su misura" in grado di adattarsi al millimetro alle esigenze di tutti.

Ladigue is a modular sofa with soft style and a comfortable, inviting appearance. The design features darts and gentle folds. The depth of the seat can be adjusted to suit your preferences in one simple step; a tailor-made seat that adapts to everyone, down to the finest detail.

Ladigue es un sofá modular de estilo soft y aspecto mullido y acogedor. Un diseño ornamentado con pinzas y suaves pliegues. La profundidad del asiento puede ajustarse según se desee con un simple gesto; un asiento "a medida" capaz de adaptarse al milímetro a las preferencias de cada usuario.

Ladigue est un canapé modulable au style soft et à l'aspect moelleux et accueillant. Un design mis en valeur par les pinces et les doux plis. Il est possible de transformer la profondeur de l'assise à son propre gré en un simple geste : une assise « sur mesure » pouvant s'adapter au millimètre aux exigences de chacun.

Ladigue ist ein kombinierbares Sofa in einem zurückhaltendem Design, weich und gemütlich. Das Design wird durch Nähte und weiche Falten unterstrichen. Die Tiefe der Sitzfläche kann mit einem einfachen Handgriff individuell angepasst werden. So entsteht eine Sitzfläche „nach Maß“, die auf den Millimeter genau an alle Anforderungen angepasst werden kann.

Ladigue - мягкий и удобный секционный диван в стиле "софт". Дизайн, характеризующийся декоративными и мягкими складками. Можно простым движением изменять глубину сиденья по собственному желанию; персонализируемое сиденье, превосходно адаптируемое к любым требованиям.









**LADIGUE** divano / sofa  
 Tessuto Mistral plain 01 /  
 Mistral plain 01 fabric L294 P104 H74  
**LADIGUE** divano / sofa  
 Tessuto Mistral plain 03 /  
 Mistral plain 03 fabric L254 P104 H74  
**NORMAN** tavolino / occasional table  
 Laccato Conchiglia opaco e lucido /  
 Matt and high gloss Conchiglia lacquered L100 P100 H33,6  
**TUFT** tavolino / occasional table  
 Laccato Bianco opaco /  
 Matt Bianco lacquered L60,3 P60,3 H36,3



**LADIGUE** divano / sofa  
Tessuto Jenny 61 /  
Jenny 61 fabric L354 P104 H74  
**TUFT** tavolino / occasional table  
Laccato Modica opaco /  
Matt Modica lacquered L40,3 P40,3 H46,3  
**TUFT** tavolino / occasional table  
Laccato Bianco opaco /  
Matt Bianco lacquered L60,3 P60,3 H36,3



**LADIGUE** divano / sofa  
Tessuto Zeph 19 /  
Zeph 19 fabric L354 P174 H74  
**WOK** tavolino / occasional table  
Laccato Anfora opaco /  
Matt Anfora lacquered L27,5 P27,5 H50  
**TUFT** tavolino / occasional table  
Laccato Modica opaco /  
Matt Modica lacquered L40,3 P40,3 H46,3  
**TUFT** tavolino / occasional table  
Verniciato Rame brunito /  
Rame brunito painted L60,3 P60,3 H36,8





**LADIGUE** divano / sofa  
Tessuto Zeph 19 /  
Zeph 19 fabric L354 P174 H74  
**WOK** tavolino / occasional table  
Laccato Anfora opaco /  
Matt Anfora lacquered L27,5 P27,5 H50  
**TUFT** tavolino / occasional table  
Laccato Modica opaco /  
Matt Modica lacquered L40,3 P40,3 H46,3  
**TUFT** tavolino / occasional table  
Verniciato Rame brunito /  
Rame brunito painted L60,3 P60,3 H36,8





# Ladigue

design **Enrico Cesana**

Rivestimento:  
Tessuti / Pelle / Ecopelle

Covering:  
Fabric / Leather /  
Ecoleather

Revestimiento:  
Tejidos / Piel / Eco-piel

Revêtement :  
Tissus / Cuir / Éco-cuir

Bezug:  
Stoff / Leder / Kunstleder

Обивка:  
Ткань / Кожа / Экокожа

## Moduli terminali sx o dx (Disponibile meccanismo seduta allungabile)

LH or RH end units (available with extendable seat mechanism) / Módulos terminales izda. o dcha. (disponible mecanismo de asiento extensible) / Modules terminaux gauches ou droits (Mécanisme pour assise allongeable disponible) / Abschlusselemente li. oder re. (Mechanismus für den Auszug der Sitzfläche erhältlich) / Терминальные лев. или прав. модули (Предусмотрен механизм удлиняемого сиденья)

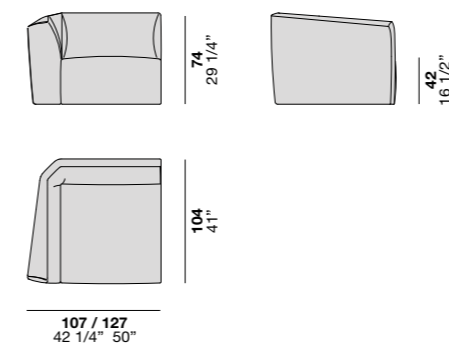

## Chaise longue sx o dx

LH or RH chaise longue / Chaise longue izda. o dcha. / Chaise longue gauche ou droite / Chaiselongue li. oder re. / Лев. или прав. шезлонги

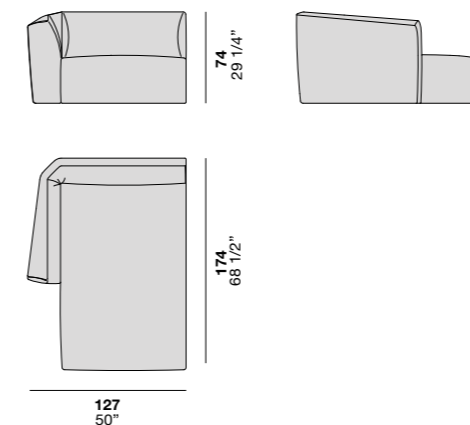

## Esempi di composizioni

Composition examples / Ejemplos de composiciones / Exemples de compositions / Beispiele für Zusammenstellungen / Примеры композиций

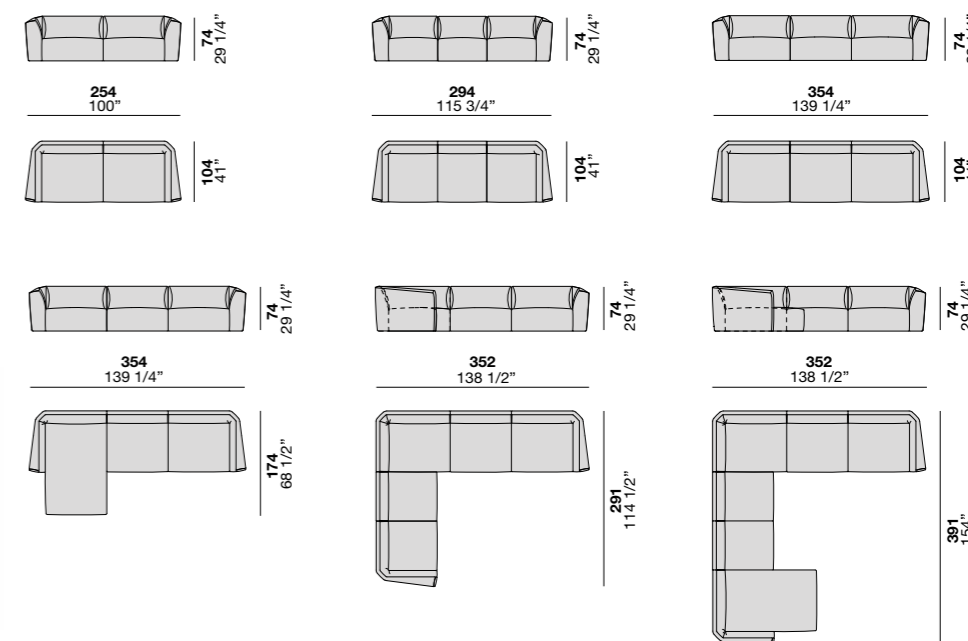

## Moduli centrali (Disponibile meccanismo seduta allungabile)

Central units (available with extendable seat mechanism) / Módulos centrales (disponible mecanismo de asiento extensible) / Modules centraux (Mécanisme pour assise allongeable disponible) / Mittelelemente (Mechanismus für den Auszug der Sitzfläche erhältlich) / Центральные модули (Предусмотрен механизм удлиняемого сиденья)

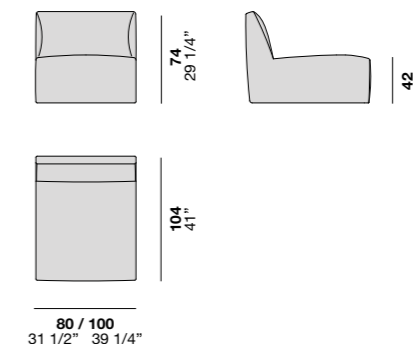

## Angoli

Corner units / Módulos de esquina / Angles / Eckelemente / Угловые модули

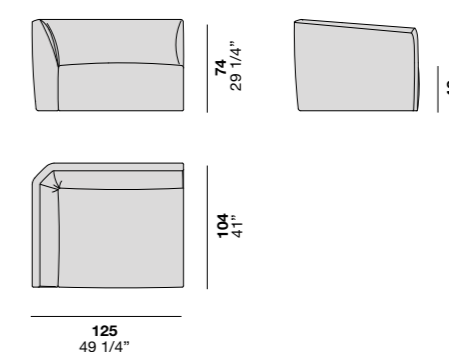

## OREGON

design Enrico Cesana

Oregon è un divano caratterizzato dalla particolare sagoma dei braccioli che creano un effetto di continuità estetica e funzionale con lo schienale. Vasta la modularità, completa di moduli angolo, chaise longue, poltrone e pouf.

The Oregon sofa stands out for the particular shape of its armrests, which create a feeling of styling and functional continuity with the seat back. Affording generous modularity, complete with corner units, chaise longue, armchairs and footstools.

Oregon es un sofá que se caracteriza por la particular forma de los reposa-brazos, que crean un efecto de continuidad estética y funcional con el respaldo. Amplias posibilidades modulares con módulos de esquina, chaise longues, sillones y puffs.

Oregon est un canapé caractérisé par la forme particulière des accoudoirs qui créent un effet de continuité esthétique et fonctionnelle avec le dossier. Vaste modularité avec modules d'angle, chaise longue, fauteuil et pouf.

Oregon ist ein Sofa mit außergewöhnlich geformten Armlehnen, die einen ästhetischen und funktionalen Übergang zur Rückenlehne bilden. Mit vielseitigen Kombinationsmöglichkeiten. Die Serie umfasst auch Eckelemente, Chaiselongue, Armlehnstühle und Polsterhocker.

Oregon - диван, характеризующийся особой формой подлокотников, создающих эффект эстетической и функциональной непрерывности со спинкой. Обширная модульность, с угловыми модулями, шезлонгами, креслами и пуфами.



**OREGON** divano / sofa  
Tessuto Tennessee 12 /  
Tennessee 12 fabric L255 P107 H84  
**OREGON** divano / sofa  
Pelle Nabuk Creta /  
Creta Nabuk leather L240 P90 H84  
**TUFT** tavolino / occasional table  
Laccato Ghisa opaco /  
Matt Ghisa lacquered L60,3 P60,3 H36,8  
**WOK** tavolino / occasional table  
Laccati Anfora e Carta da zucchero opaco /  
Matt Anfora and Carta da zucchero lacquered  
L27,5 P27,5 H43  
**WOK BOX** tavolino / occasional table  
Laccato Fango opaco, laccato Carta da zucchero /  
Matt Fango lacquered, Carta da zucchero lacquered  
L35 P35 H43







**OREGON** divano / sofa  
Tessuto Wonderful 07 / Wonderful 07 fabric L345 P130 H84  
**TUFT** tavolino / occasional table  
Verniciato Bianco / Bianco painted L60,3 P60,3 H36,8  
**WOK BOX** tavolino / occasional table  
Laccato Carta da zucchero e Fango opaco /  
Matt Carta da zucchero and Fango lacquered L35 P35 H43  
**JET SET** poltrona / armchair  
Tessuto Nina 27 / Nina 27 fabric L77 P87 H80  
**FREE+POD** libreria / bookcase  
Laccato Bianco opaco, mensole laccato Platino e Tortora opaco /  
Matt Bianco lacquered, shelves in Matt Platino and Tortora lacquered  
L768 P33,6 H64

# Oregon

design **Enrico Cesana**

**Rivestimento:**  
Tessuti / Pelle / Ecopelle

**Covering:**  
Fabric / Leather /  
Ecoleather

**Revestimiento:**  
Tejidos / Piel / Eco-piel

**Revêtement :**  
Tissus / Cuir / Éco-cuir

**Bezug:**  
Stoff / Leder / Kunstleder

**Обивка:**  
Ткань / Кожа / Экокожа

**Esempi di composizioni**  
Composition examples / Ejemplos de composiciones  
/ Exemples de compositions / Beispiele für  
Zusammenstellungen / Примеры композиций

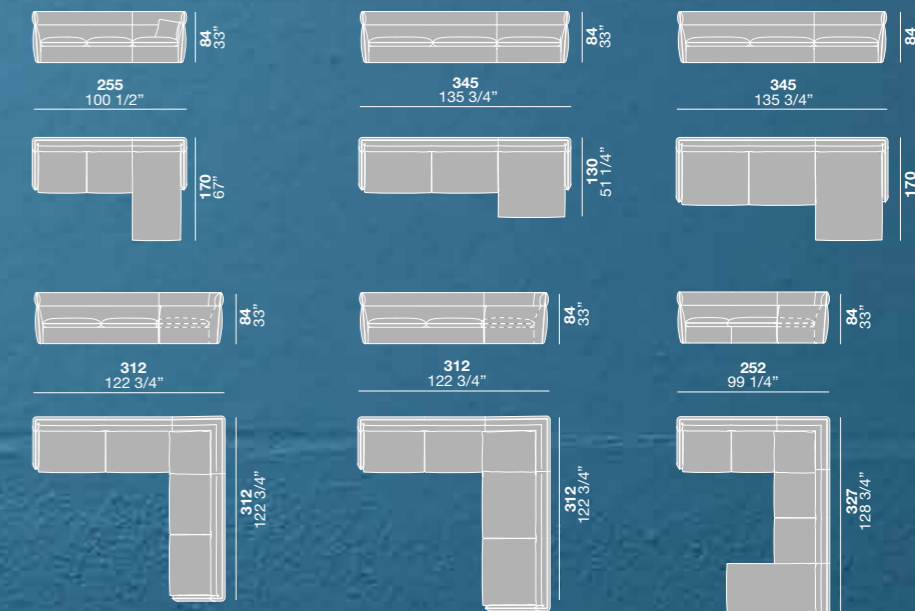

## OSLO

design Enrico Cesana

**Oslo è un divano in cui le morbide imbottiture si fondono alla forma regolare di base e braccioli. Piacevolmente sospeso da piedi in metallo verniciato, Oslo è disponibile in cinque larghezze e due varianti di poltrona.**

**OSLO** divano / sofa  
Pelle Nabuk Creta /  
Creta Nabuk leather L260 P93 H83  
**TUFT** tavolino / occasional table  
Verniciato Moka shine /  
Moka shine lacquered L40,3 P40,3 H46,3  
**TUFT** tavolino / occasional table  
Verniciato Rame brunito,  
piano Fashion wood Rovere Carbone /  
Rame brunito painted,  
top in Carbone oak Fashion wood  
L60,3 P60,3 H36,8  
**NOBEL** credenza / sideboard  
Fashion wood Rovere Terra,  
basamento Rame brunito /  
Terra oak Fashion wood,  
Rame brunito basement  
L256,5 P52,7 H68,4  
**AIR** tavolino / occasional table  
Fashion wood Rovere Carbone /  
Carbone oak Fashion wood  
L120 P20 H35

The Oslo sofa features soft padding that appears to sink into the regular shape of its base and armrests. Pleasantly suspended by painted metal feet, Oslo is available in five widths and two armchair versions.

En el sofá Oslo, los mullidos rellenos se funden con la forma regular de la base y los reposabrazos. Oslo descansa con elegancia sobre patas de metal barnizado y está disponible en cinco anchos y dos variantes de sillón.

Oslo est un canapé sur lequel les rembourrages moelleux se confondent avec la forme régulière de base et les accoudoirs. Agréablement suspendu sur des pieds en métal verni, Oslo est disponible en cinq largeurs et deux variantes de fauteuil.

Oslo ist ein Sofa, dessen weiche Sitzpolster mit der geraden Form des Gestells und der Armlehnen verschmelzen. Es steht auf zwei formschönen Füßen aus lackiertem Metall. Oslo ist in fünf Breiten und zwei Armlehnstuhlvarianten erhältlich.

Oslo - диван, мягкая набивка которого сочетается с правильной формой основания и подлокотников. Oslo на ножках из крашеного металла предусмотрен в пяти вариантах ширины и двух вариантах кресла.



## Oslo

design **Enrico Cesana**

**Rivestimento:**  
Tessuti / Pelle / Ecopelle  
**Piedini:**  
Verniciato moka shine /  
Verniciato rame brunito

**Covering:**  
Fabric / Leather / Ecoleather  
**Feet:**  
Moka shine painted / rame  
brunito painted

**Revestimiento:**  
Tejidos / Piel / Eco-piel  
**Patas:**  
Barnizado moka shine /  
Barnizado rame brunito

**Revêtement :**  
Tissus / Cuir / Éco-cuir  
**Pieds :**  
Verni moka shine / Verni  
rame brunito

**Bezug:**  
Stoff / Leder / Kunstleder  
**Füße:**  
lackiertes Moka shine /  
Brüniertes und lackiertes  
Kupfer

**Обивка:**  
Ткань / Кожа / Экокожа  
**Ножки:**  
Крашенный moka shine /  
Крашенный rame brunito





# Oslo

design **Enrico Cesana**

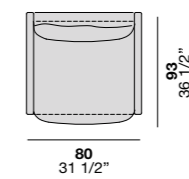
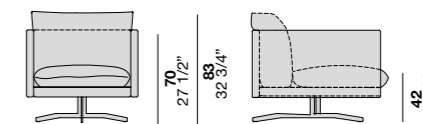
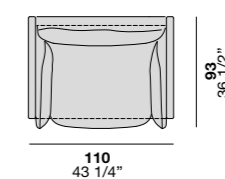
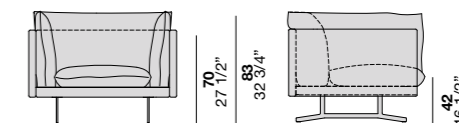
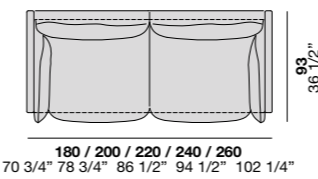
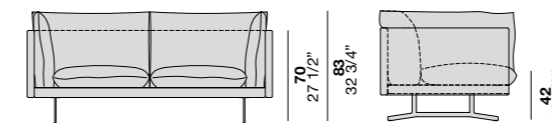

## STOCCOLMA

design Enrico Cesana

Stoccolma è un divano in cui le morbide imbottiture si fondono alla forma regolare di base e braccioli. Caratterizzato da una gonna che arriva a terra, Stoccolma è disponibile in cinque larghezze e due varianti di poltrona.

The Stoccolma sofa features soft padding that appears to sink into the regular shape of its base and armrests. Distinguished by a floor-length valance, Stoccolma is available in five widths and two armchair versions.

En el sofá Stoccolma, los mullidos rellenos se funden con la forma regular de la base y los reposa-brazos. Stoccolma se caracteriza por un faldón que llega hasta el suelo, y está disponible en cinco anchos y dos variantes de sillón.

Stoccolma est un canapé sur lequel les rembourrages moelleux se confondent avec la forme régulière de base et les accoudoirs. Caractérisé par une jupe qui arrive jusqu'au sol, Stoccolma est disponible en cinq largeurs et deux variantes de fauteuil.

Stoccolma ist ein Sofa, dessen weiche Sitzpolster mit der geraden Form des Gestells und der Armlehnen verschmelzen. Die Blende reicht bis zum Boden. Stoccolma ist in fünf Breiten und zwei Armlehnstuhlvarianten erhältlich.

Stoccolma - диван, мягкая набивка которого сочетается с правильной формой основания и подлокотников. Stoccolma, характеризующийся юбкой, спускающейся до поверхности пола, предусмотрен в пяти вариантах ширины и двух вариантах кресла.



**STOCCOLMA** divano / sofa  
Tessuto Nina 23 / Nina 23 fabric

L260 P93 H83

**UP** libreria / bookcase

Struttura verniciato nero trasparente lucido,  
mensole Fashion wood Rovere Terra /  
Structure in gloss transparent black painted,  
shelves in Terra oak Fashion wood

L359,4 P33,2 H99,8

**KOBE** tavolino / occasional table

Struttura verniciato nero trasparente lucido,  
piano Fashion wood Rovere Terra /  
Structure in gloss transparent black painted,  
top in Terra oak Fashion wood

L45 P45 H50



**STOCCOLMA** divano / sofa

COMPLEMENTS

Alf DaFrè



# Stoccolma

design **Enrico Cesana**

**Rivestimento:**

Tessuti / Pelle / Ecopelle

**Covering:**

Fabric / Leather / Ecoleather

**Revestimiento:**

Tejidos / Piel / Eco-piel

**Revêtement :**

Tissus / Cuir / Éco-cuir

**Bezug:**

Stoff / Leder / Kunstleder

**Обивка:**

Ткань / Кожа / Экокожа

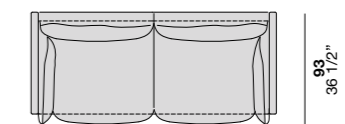
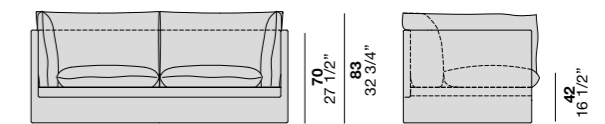

180 / 200 / 220 / 240 / 260  
70 3/4" 78 3/4" 86 1/2" 94 1/2" 102 1/4"

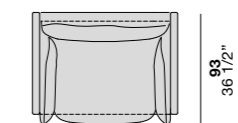
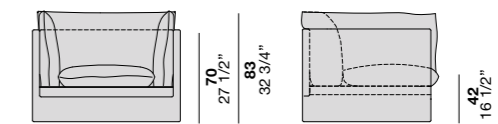

110  
43 1/4"

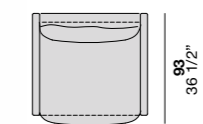
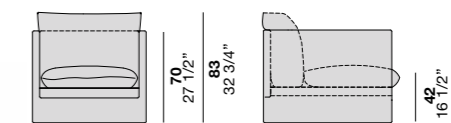

80  
31 1/2"





## UTAH

design Enrico Cesana

Utah è un divano dalla forma rigorosa, caratterizzato da piacevoli “intersezioni” tra sedute, schienali e braccioli.

Appoggiato a quattro eleganti piedi in metallo verniciato, è completato nella modularità da angoli, chaise longue, poltrone e pouf.

The Utah sofa has a strikingly simple shape, which stands out for its enchanting “crossroads” between seat cushions, seat backs and armrests. Resting on four stylish painted metal feet, its modularity is completed by corner units, chaise longue, armchairs and footstools.

Utah es un sofá de formas rigurosas, caracterizado por agradables “intersecciones” entre los asientos, respaldos y reposa-brazos. Se sostiene sobre cuatro elegantes patas de metal barnizado y presenta posibilidades modulares añadidas gracias a módulos de esquina, chaise longues, sillones y puffs.

Utah est un canapé à la forme rigoureuse, caractérisé par agréables “intersections” entre assises, dossiers et accoudoirs. Posé sur quatre élégants pieds en métal verni, des angles, une chaise longue, un fauteuil et un pouf complètent sa modularité.

Utah ist ein Sofa, dessen strenge Formen durch spielerisch durch Sitzflächen, Rückenlehnen und Armlehnen durchbrochen werden. Es steht auf vier eleganten Füßen aus lackiertem Metall. Die Serie umfasst Eckelemente, Chaiselongue, Armlehnstühle und Polsterhocker.

Utah - диван строгих форм, характеризующийся приятными “вставками” между сиденьями, спинками и подлокотниками. На четырех элегантных ножках из крашеного металла, дополняется в модульности угловыми элементами, шезлонгами, креслами и пуфами.



**UTAH** divano / sofa  
Pelle Nabuk Seppia / Seppia Nabuk leather  
L375 P140 H78  
**MOKA** tavolino / occasional table  
Laccato Bianco opaco / Matt Bianco lacquered  
L60 P60 H45,4  
**KOBE** tavolino / occasional table  
Struttura verniciato nero trasparente lucido,  
piano Fashion wood Rovere Terra /  
Structure in gloss transparent black painted,  
top in Terra oak Fashion wood  
L45 P45 H50  
**KOBE** tavolino / occasional table  
Laccato Tè verde opaco /  
Matt Tè verde lacquered  
L120 P70 H33



# Utah

design **Enrico Cesana**

**Rivestimento:**  
Tessuti / Pelle / Ecopelle  
**Piedini:**  
Verniciato ghisa

**Covering:**  
Fabric / Leather /  
Ecoleather  
**Feet:**  
Ghisa painted

**Revestimiento:**  
Tejidos / Piel / Eco-piel  
**Patas:**  
Barnizado ghisa

**Revêtement :**  
Tissus / Cuir / Éco-cuir  
**Pieds :**  
Verni ghisa

**Bezug:**  
Stoff / Leder / Kunstleder  
**FüÙe:**  
Lackiertes Gusseisen

**Обивка:**  
Ткань / Кожа / Экокожа  
**Ножки:**  
Крашеный ghisa



# Utah

design **Enrico Cesana**

## Divani

Sofas / Divani / Sofás / Canapés / Sofas / Диваны

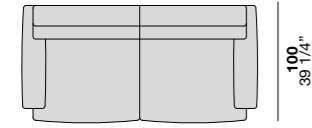
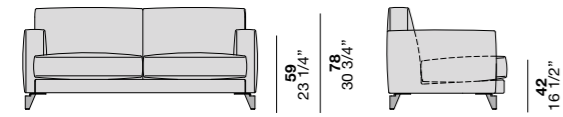

180 / 200 / 220 / 240 / 260  
70 3/4" 78 3/4" 86 1/2" 94 1/2" 102 1/4"

## Moduli terminali sx o dx

LH or RH end units / Módulos terminales izda. o dcha. / Modules terminaux gauches ou droits / Abschlusselemente li. oder re. / Терминальные лев. или прав. модули

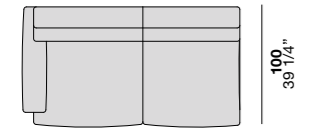
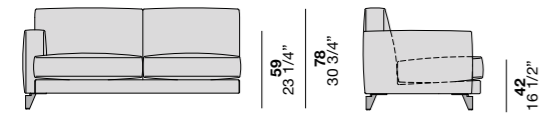

165 / 185 / 205 / 225 / 245  
65" 72 3/4" 80 3/4" 88 1/2" 96 1/2"

## Poltrona

Armchair / Sillón / Fauteuil / Armlehnstuhl / Кресло

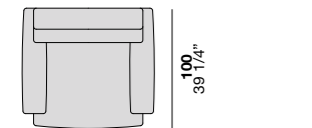
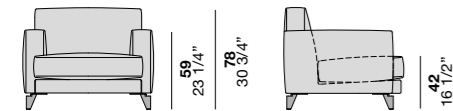

100 39 1/4"

068

## Angoli

Corner units / Módulos de esquina / Angles / Eckelemente / Угловые модули

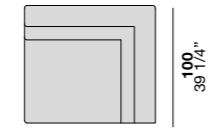
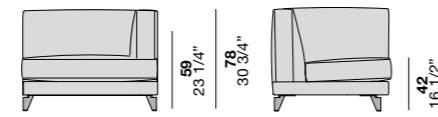

100 39 1/4"

## Chaise longue sx o dx

LH or RH chaise longue / Chaise longue izda. o dcha. / Chaise longue gauche ou droite / Chaiselongue li. oder re. / Лев. или прав. шезлонги

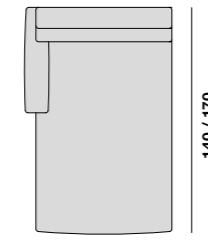
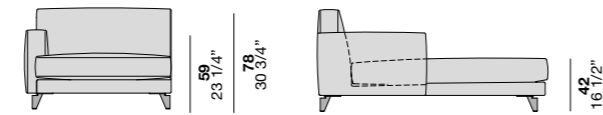

110 / 130 43 1/4" 51 1/4"

## Pouf

Pouf / Puffs / Pouf / Polsterhocker / Пуфы

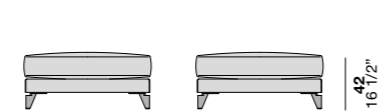

100 39 1/4"

## Esempi di composizioni

Composition examples / Ejemplos de composiciones / Exemples de compositions / Beispiele für Zusammenstellungen / Примеры композиций

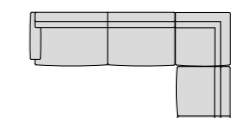
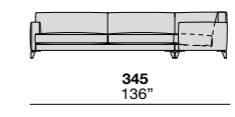
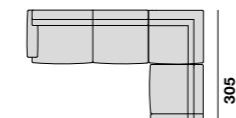
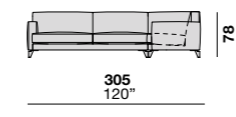
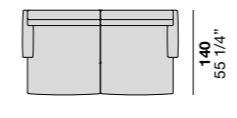
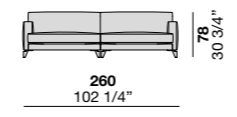
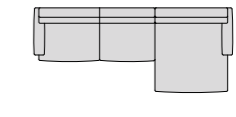
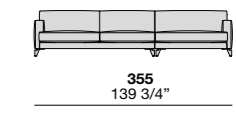
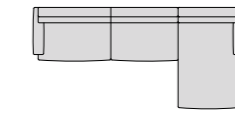
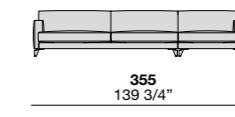
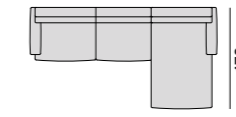
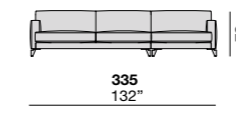
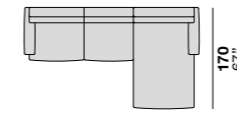
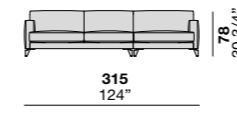

069

## DENNY

design R.D.A.

Denny è un pouf imbottito e sfoderabile (nelle versioni tessuto) disponibile in tre misure. Caratterizzato da forme tondeggianti e rastremate funge da seduta o pratico appoggio.

Denny is a padded footstool with removable cover (in the fabric version), which is available in three sizes. It is distinguished by rounded and tapered shapes, and it can be used as either a seat or a practical rest.

Denny es un puff tapizado y desenfundable (en las versiones de tejido) disponible en tres tamaños. Caracterizado por unas formas redondeadas y ahusadas, sirve de asiento o cómodo apoyo.

Denny est un pouf rembourré et déhoussable (dans les versions tissu) disponible en trois dimensions. Caractérisé par des formes arrondies et affinées il sert d'assise ou de pratique appui.

Denny ist ein Polsterhocker mit abnehmbarem Bezug (in den Versionen mit Stoff) und ist in drei Größen erhältlich. Seine runde und sich nach oben verjüngende Form dient als Sitzfläche oder praktische Ablagefläche.

Denny - мягкий со снимаемой обивкой пуф (в тканевом варианте) предусмотрен в трех размерах. Характеризуется закругленными и суженными формами, предусмотрен в качестве сиденья или практичной опоры.





**NORMAN** tavolino / occasional table  
 Rovere laccato opaco Platino, laccato Platino lucido /  
 Matt laquered oak Platino, High gloss Platino lacquered  
 L120 P70 H33,6  
**DENNY** pouf /pouf  
 Tessuto Zeph 01 / Zeph 01 fabric L55 P55 H42  
**DENNY** pouf /pouf  
 Tessuto Tennessee 11 / Tennessee 11 fabric L55 P55 H42  
**CALIFORNIA** divano / sofa  
 Tessuto Zeph 12 / Zeph 12 fabric L316 P100 H84



**RALPH** letto / bed  
Pelle Alfa 4250 /  
Alfa 4250 leather L173,5 P224 H112,6  
**DENNY** pouf / pouf  
Tessuto Mistral Plain 01 /  
Mistral Plain fabric L142 P55 H42





076

# Denny

design R.D.A.

## Materiali e finiture

Rivestimento:  
Tessuti / Pelle / Ecopelle

## Materials and finishes

Covering:  
Fabric / Leather / Ecoleather

## Materiales y acabados

Revestimiento:  
Tejidos / Piel / Eco-piel

## Matériaux et finitions

Revêtement :  
Tissus / Cuir / Éco-cuir

## Materialien und Ausführungen

Bezug:  
Stoff / Leder / Kunstleder

## Материалы и варианты отделки

Обивка:  
Ткань / Кожа / Экокожа

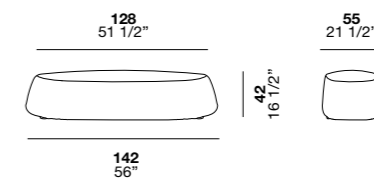
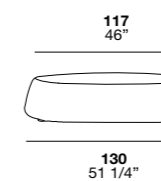
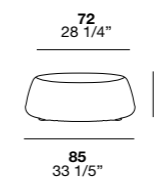
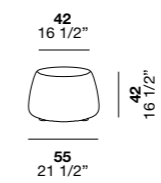

077



## JET SET

design R.D.A.

Jet Set è una poltroncina imbottita e sfoderabile (nella versione tessuto ed ecopelle) disponibile nelle varianti con piedi, con basamento girevole e con gonna.

Questa poltroncina è caratterizzata da linee morbide enfatizzate da un bordino in contrasto. Il pratico poggiapiedi è il suo complemento ideale.

**Jet Set** poltrona / armchair  
Tessuto Wonderful 08 /  
Wonderful 08 fabric L77 P87 H80  
**Jet Set** poggiapiedi / footstool  
Tessuto Nina 40 /  
Nina 40 fabric L66 P64 H40

Jet Set is a padded armchair with removable cover (in the fabric and ecoleather version), which is available in versions with feet, with swivel base and with valance.

This armchair is distinguished by soft silhouettes which are emphasised by a contrasting border. The practical footstool is its perfect companion.

Jet Set es un sillón tapizado y desenfundable (en las versiones de tejido y eco-piel), disponible en las variantes con patas, con base giratoria y con faldón. Este sillón se caracteriza por sus suaves líneas resaltadas por un ribete en contraste. El cómodo reposa-pies es su complemento ideal.

Jet Set est un petit fauteuil rembourré et déhoussable (dans la version tissu et éco-cuir) disponible avec pieds à pivotement et avec jupe. Ce petit fauteuil est caractérisé par des lignes douces mises en évidence par un bord en contraste. Le pratique appui-pieds est son complément idéal.

Jet Set ist ein gepolsterter Armlehnstuhl mit abnehmbarem Bezug (in der Version mit Stoff- oder Kunstlederbezug). Er ist in den Varianten mit Füßen, Drehgestell oder einer Blende erhältlich. Dieser Polsterstuhl zeichnet sich durch weiche Linien aus, die durch kontrastierende Ränder unterstrichen werden. Durch den praktischen Fußhocker wird er ideal ergänzt.

Jet Set - мягкое со снимаемой обивкой кресло (в тканевом варианте и из экокожи) предусмотрено на ножках, с поворачиваемым основанием и с юбкой. Это кресло характеризуется мягкими линиями, подчеркиваемыми контрастной кромкой. Практичная подставка для ног представляет собой идеальное дополнение.





# Jet Set

design R.D.A.

## Materiali e finiture

Rivestimento:  
Tessuti / Pelle / Ecopelle

## Materials and finishes

Covering:  
Fabric / Leather / Ecoleather

## Materiales y acabados

Revestimiento:  
Tejidos / Piel / Eco-piel

## Matériaux et finitions

Revêtement :  
Tissus / Cuir / Éco-cuir

## Materialien und Ausführungen

Bezug:  
Stoff / Leder / Kunstleder

## Материалы и варианты отделки

Обивка:  
Ткань / Кожа / Экокожа

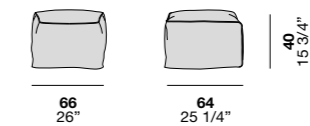
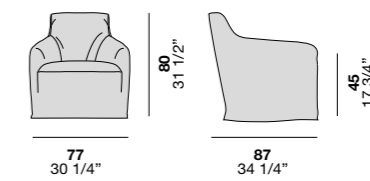
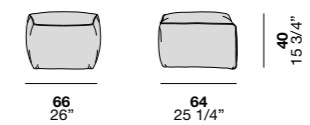
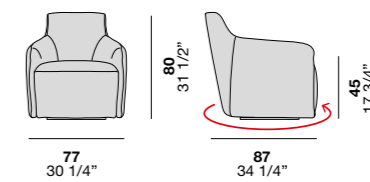
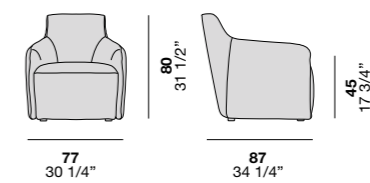

## ODETTE

design Carlo Trevisani

**Odette è una poltroncina imbottita e sfoderabile caratterizzata da un unico volume in cui seduta e schienale risultano separate e al tempo stesso continue. Un design dalla forte personalità che ricorda la silhouette di un cigno.**

Odette is a padded armchair with removable cover. It forms a single shape where the seat and back are both one and separate. This feature piece also evokes the silhouette of a swan.

Odette es un sillón tapizado y desenfundable caracterizado por un único volumen en el que el asiento y el respaldo están separados pero forman un continuo al mismo tiempo. Un diseño de marcada personalidad que recuerda a la silueta de un cisne.

Odette est un petit fauteuil rembourré et déhoussable caractérisé par un volume unique où l'assise et le dossier sont séparés tout en étant continus. Un design d'une forte personnalité qui rappelle la silhouette d'un cygne.

Odette ist ein gepolsterter Armlehnstuhl mit abnehmbarem Bezug aus einem Guss, bei dem Sitzfläche und Rückenlehne getrennt sind, aber ineinander überzugehen scheinen. Ein Design mit einer starken Persönlichkeit, das an die Gestalt eines Schwans erinnert.

Odette - мягкое кресло со снимаемой обивкой, характеризующееся единым объемом, в котором сиденье и спинка разделены и в то же время непрерывны. Характерный дизайн, напоминающий силуэт лебедя.



ODETTE poltrona / armchair

COMPLEMENTS

Alf DaFrè



**ODETTE** poltrona / armchair  
 Tessuto St. Moritz 154 /  
 St. Moritz 154 fabric L60,3 P87,8 H87  
**RIM** tavolino / occasional table  
 Laccato Piombo opaco, Laccato Ghiaino opaco /  
 Matt Piombo lacquered, Matt Ghiaino lacquered L40 P40 H52  
**WOK BOX** tavolino / occasional table  
 Laccato Piombo opaco, Laccato Ghiaino opaco /  
 Matt Piombo lacquered, Matt Ghiaino lacquered L35 P35 H43  
**WOK** tavolino / occasional table  
 Laccato Piombo opaco, Laccato Ghiaino opaco /  
 Matt Piombo lacquered, Matt Ghiaino lacquered L27,5 P27,5 H50



## Odette

design Carlo Trevisani

### Materiali e finiture

Struttura: Struttura in metallo, poliuretani a densità differenziata  
 Rivestimento: Tessuti, Pelle, Ecopelle

### Materials and finishes

Frame: Metal frame and polyurethane of different densities  
 Upholstery: Fabric, leather, ecoleather

### Materiales y acabados

Estructura: Estructura de metal, poliuretanos de diferentes densidades  
 Revestimiento: Tejidos, Piel, Eco-piel

### Matériaux et finitions

Structure : Structure en métal, polyuréthane à densité différenciée  
 Revêtement : Tissu, Cuir, Éco-cuir

### Materialien und Ausführungen

Korpus: Korpus aus Metall, PU-Schaum mit unterschiedlichen Dichten  
 Bezug: Stoff, Leder, Kunstleder

### Материалы и варианты отделки

Каркас: Металлический каркас, пенополиуретан различной плотности  
 Обивка: Ткань, Кожа, Экокожа

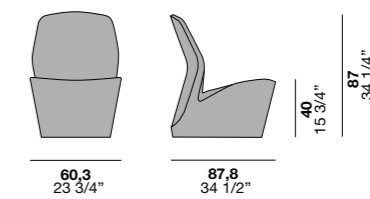

Aif DaFrè

## OLIVIA

design Bruna Vaccher

**Olivia è una poltrona e poggiatesta imbottiti con basamento girevole in metallo.**

**Il design di Olivia è caratterizzato dalla forma “aperta” con un accenno di deformazione ad indicare la possibilità ad accogliere le più svariate posizioni.**

Olivia is a padded armchair and footstool pair with a metal swivel base. Olivia's design is open and features a hint of contortion to show how it can be suited to the most varied of positions.

Olivia es un conjunto de sillón y reposapiés tapizados con base giratoria de metal. El diseño de Olivia se caracteriza por su forma “abierta” con una leve deformación que indica la posibilidad de acoger las más variadas posturas.

Olivia est un canapé et appui-pieds rembourrés avec piètement pivotant en métal. Le design de Olivia est caractérisé par sa forme « ouverte » avec une esquisse de déformation pour indiquer la possibilité d'accueillir les plus différentes positions.

Olivia ist ein gepolsterter Armlehnstuhl mit Fußhocker mit einem Drehgestell aus Metall. Das Design von Olivia zeichnet sich durch seine offene und etwas ausladende Form aus, die dazu einlädt, es sich in den unterschiedlichsten Positionen darin gemütlich zu machen.

Olivia - мягкое кресло и подставка для ног с поворачиваемым металлическим основанием. Дизайн Olivia характеризуется “открытой” формой с намеком на деформацию для указания возможности принятия самых разных положений.



**OLIVIA** poltrona / armchair  
Tessuto St. Moritz 162, basamento Moka shine /  
St. Moritz 162 fabric, basament in Moka shine L106 P93 H89  
**OLIVIA** poggiatesta / footstool  
Tessuto St. Moritz 162, basamento Moka shine /  
St. Moritz 162 fabric, basament in Moka shine L68 P49 H41  
**OLIVIA** poltrona / armchair  
Tessuto Mistral plain 11, basamento Moka shine /  
Mistral plain 11 fabric, basament in Moka shine L106 P93 H89





**OLIVIA** poltrona / armchair  
Pelle Nabuk Seppia, basamento Moka shine /  
Seppia Nabuk leather, basement in Moka shine L106 P93 H89  
**OLIVIA** poggiapiedi / footstool  
Pelle Nabuk Seppia, basamento Moka shine /  
Seppia Nabuk leather, basement in Moka shine L68 P49 H41





# Olivia

design **Bruna Vaccher**

## Materiali e finiture

Struttura: Telaio in legno, poliuretani a densità differenziata  
 Rivestimento: Tessuti, Pelle, Ecopelle  
 Basamento: Metallo

## Materials and finishes

Frame: wooden frame, and polyurethane of different densities  
 Upholstery: fabric, leather, ecoleather  
 Base: metal

## Materiales y acabados

Estructura: Armazón de madera, poliuretanos de diferentes densidades  
 Revestimiento: Tejidos, Piel, Eco-piel  
 Base: Metal

## Matériaux et finitions

Structure : Châssis en bois, polyuréthane à densité différenciée  
 Revêtement : Tissu, Cuir, Éco-cuir  
 Piètement : Métal

## Materialien und Ausführungen

Korpus: Rahmen aus Holz, PU-Schaum mit unterschiedlichen Dichten  
 Bezug: Stoff, Leder, Kunstleder  
 Untergestell: Metall

## Материалы и варианты отделки

Каркас: Деревянный каркас, пенополиуретан различной плотности  
 Обивка: Ткань, Кожа, Экокожа  
 Основание: Металлическое

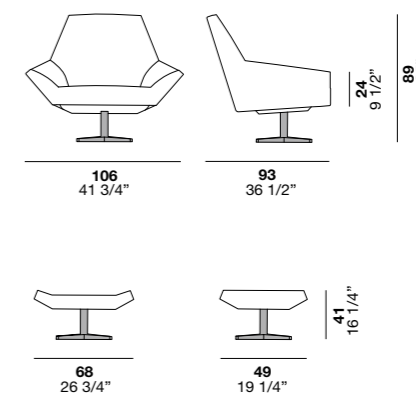

**tavolini**

occasional tables

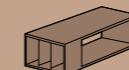
**Air**  
pag. 098**Tuft**  
pag. 140**Ceppo**  
pag. 104**Wok**  
pag. 146**Kobe**  
pag. 108**Wok Box**  
pag. 146**Life**  
pag. 116**Moca**  
pag. 120**Norman**  
pag. 126**Rim**  
pag. 134

## AIR

design Marelli e Molteni Architetti

**Air è un tavolino quadrato con struttura in legno disponibile in tre misure. Air si caratterizza per un disegno pulito e gambine inclinate verso l'esterno.**

The Air square occasional table has a wooden structure and it is available in three sizes. Air stands out for its clean-cut design and legs that tilt outwards.

Air es una mesita cuadrada con estructura de madera disponible en tres tamaños. Air se caracteriza por un diseño limpio y una pequeñas patas inclinadas hacia afuera.

Air est une table basse carrée avec structure en bois disponible en trois dimensions. Air est caractérisée par un dessin net et des pieds inclinés vers l'extérieur.

Air ist ein quadratischer Beistelltisch mit einem Korpus aus Holz und in drei Größen erhältlich. Air zeichnet sich durch sein schlichtes Design und die nach außen geneigten Beine aus.

Air - квадратный столик с деревянным каркасом, предусмотрен в трех вариантах размера. Air характеризуется чистыми формами и наклонными ножками.





AIR tavolino / occasional table  
Fashion wood Rovere Fossile /  
Fossile oak Fashion wood L127,3 P127,3 H35



# Air

design **Marelli e Molteni Architetti**

### Materiali e finiture

Struttura:  
Fashion wood / Rovere colori opachi

### Materials and finishes

Structure:  
Fashion wood / Oak matt colours

### Materiales y acabados

Estructura:  
Fashion wood / Roble teñido colores mate

### Matériaux et finitions

Structure :  
Fashion wood / Chêne laqué mat

### Materialien und Ausführungen

Korpus:  
Fashion Wood / Eiche matte Farben

### Материалы и варианты отделки

Каркас:  
Fashion wood / Дуб матовых цветов

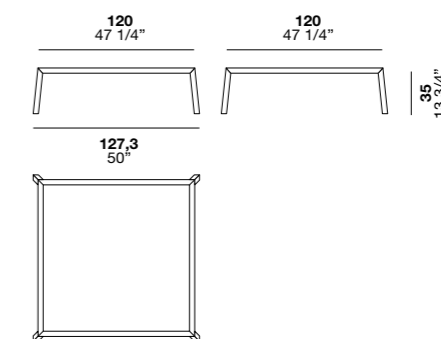
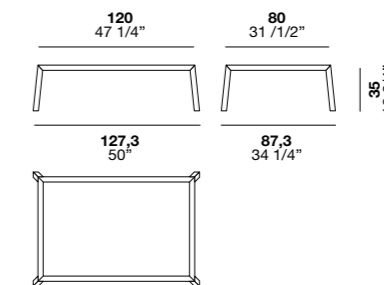
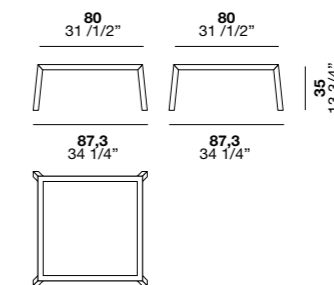

## CEPPO

design R.D.A.

Ceppo è un tavolino ricavato da un unico pezzo di tronco di rovere cresciuto sulle rive dei fiumi. Segato, scortecciato e levigato è distinto da un caldo colore naturale e fini spaccature.

The Ceppo occasional table is built using a single piece of oak trunk grown on riverbanks. Sawn, debarked and smoothed, it stands out for its warm natural colour and fine cracks.

Ceppo es una mesita elaborada a partir de una única pieza de tronco de roble procedente de orillas fluviales. La madera aserrada, descortezada y lijada se distingue por un cálido tono natural y leves fisuras.

Ceppo est une table basse obtenue à partir d'un seul tronc de chêne grandi sur les rives des fleuves. Scié, écorcé et poli, il se distingue pour son coloris naturel et chaud et pour ses fines fissures.

Ceppo ist ein Beistelltisch aus einem Stück Eichenholz eines Baums, der von einem Flussufer stammt. Nach dem Sägen und Entrinden wurde das Holz geschliffen, sodass die Wärme seiner natürlichen Farbe und die feinen Risse im Material zur Geltung kommen.

Серро - столик, изготовленный из единого элемента дуба речных побережий. Срубленный, очищенный от коры и отполированный, характеризуется теплым натуральным цветом и тонкими прорезями.

CEPPO tavolo / occasional table  
Rovere / Oak L30 P30 H37/47

CEPPO tavolino / occasional table

COMPLEMENTS

Aif DaFrè



# Ceppo

design R.D.A.

## Materiali e finiture

Struttura:  
Rovere

## Materials and finishes

Structure:  
Oak

## Materiales y acabados

Estructura:  
Roble

## Matériaux et finitions

Structure :  
Chêne

## Materialien und Ausführungen

Korpus:  
Eiche

## Материалы и варианты отделки

Каркас:  
Дуб

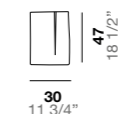
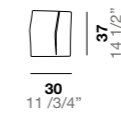

## KOBE - HANDY KOBE

design R.D.A.

Kobe è un tavolino quadrato o rettangolare con struttura in metallo verniciato e piano legno. Estremamente pulito nella linea è disponibile in quattro misure.

Kobe is a square or rectangular occasional table with a painted metal structure and a wooden top. It has an extremely clean-cut silhouette and it is available in four sizes.

Kobe es una mesita cuadrada o rectangular con estructura de metal barnizado y sobre de madera. Presenta unas líneas sumamente limpias y está disponible en cuatro tamaños.

Kobe est une table basse carrée ou rectangulaire avec structure en métal verni et plateau en bois. À la ligne extrêmement nette, elle est disponible en quatre dimensions.

Kobe ist ein quadratischer oder rechteckiger Beistelltisch mit einem Korpus aus lackiertem Metall und einer Platte aus Holz. Dieser Tisch mit seinem äußerst geradlinigen Design ist in vier Größen erhältlich.

Kobe - квадратный или прямоугольный столик с металлическим крашеным каркасом и деревянной столешницей. Характеризуется максимально чистыми линиями, предусмотрен в четыре размерах.



KOBE tavolino / occasional table

COMPLEMENTS

Alf DaFrè



**COPENAGHEN** divano / sofa  
Tessuto Salò 05 / Salò 05 fabric

L260 P91 H86

**MOCA** tavolino / occasional table  
Struttura laccato Ghisa opaco,  
piano Fashion wood Rovere Terra /  
Structure in Matt Ghisa lacquered,  
top in Terra oak Fashion wood

L60 P60 H45,4

**WOK** tavolino / occasional table  
Laccato Anfora opaco /  
Matt Anfora lacquered

L27,5 P27,5 H50

**KOBE** tavolino / occasional table  
Struttura laccato Platino opaco,  
piano Ceramica Limestone ash /  
Structure in Matt Platino lacquered,  
top in Ceramic Limestone ash

L120 P70 H33





**UTAH** divano / sofa  
 Pelle Nabuk Seppia /  
 Seppia Nabuk leather L375 P140 H78  
**MOCA** tavolino / occasional table  
 Laccato Bianco opaco /  
 Matt Bianco lacquered L60 P60 H45,4  
**KOBE** tavolino / occasional table  
 Struttura verniciato nero trasparente lucido,  
 piano Fashion wood Rovere Terra /  
 Structure in gloss transparent black painted,  
 top in Terra oak Fashion wood L45 P45 H50  
**KOBE** tavolino / occasional table  
 Laccato Tè verde opaco /  
 Matt Tè verde lacquered L120 P70 H33



## Kobe - Handy Kobe

design R.D.A.

### Materiali e finiture

Piano:  
 Rovere termocotto / Fashion wood / Rovere colori opachi /  
 Laccati opachi / Laccati lucidi / Ceramica  
 Struttura:  
 Verniciato bianco / Verniciato nero trasparente lucido /  
 Laccati opachi

### Materials and finishes

Top:  
 Baked Oak / Fashion wood / Oak matt colours / Matt  
 colours / High gloss colours / Ceramic  
 Structure:  
 Bianco painted / high gloss transparent nero painted /  
 Matt colours

### Materiales y acabados

Sobre:  
 Roble termotratado / Fashion wood / Roble teñido colo-  
 res mate / Colores mate / Colores brillantes / Cerámica  
 Estructura:  
 Barnizado blanco / Barnizado negro transparente brillante  
 / Colores mate

### Matériaux et finitions

Plateau :  
 Chêne thermo-traité / Fashion Wood / Chêne laqué mat /  
 Laqués mats / Laqués brillants / Céramique  
 Structure :  
 Verni bianco / Verni nero transparent brillant / Laqués  
 mats

### Materialien und Ausführungen

Platte:  
 Thermo-Eiche / Fashion Wood / Eiche matte Farben /  
 Matte Farben / Glänzende Farben / Keramik  
 Korpus:  
 Lackiert Bianco / Lackiert Nero transparent glänzend /  
 Matte Farben

### Материалы и варианты отделки

Столешница:  
 Дуб термокотто / Fashion wood / Дуб матовых цветов /  
 Матовые цвета / Глянцевые цвета / керамика  
 Каркас:  
 Крашенный bianco / Крашенный nero прозрачный  
 глянцевый / Матовые цвета

### Kobe

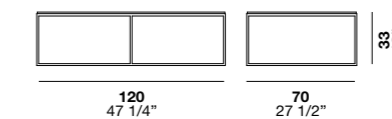
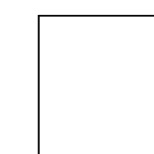
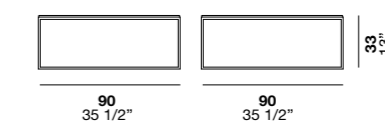
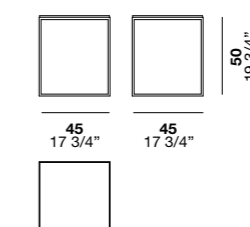

### Handy Kobe

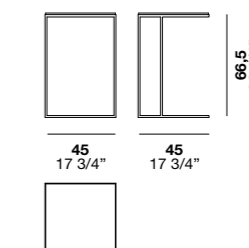
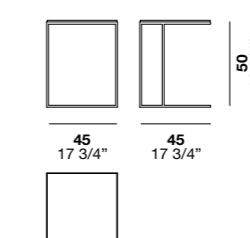

## LIFE

design Haften Studio

Life è un tavolino con struttura legno disponibile in tre varianti: rotondo con tre gambe e rettangolare con quattro gambe in due misure.

The Life occasional table has a wooden structure available in three versions: round with three legs, or rectangular with four legs, in two different sizes.

Life es una mesita con estructura de madera disponible en tres variantes: redonda con tres patas y rectangular con cuatro patas en dos tamaños.

Life est une table basse avec structure en bois disponible en trois variantes : ronde avec trois pieds et rectangulaire avec quatre pieds en deux dimensions.

Life ist ein Beistelltisch mit einem Korpus Holz und in drei Varianten erhältlich: rund mit drei Beinen und rechteckig mit vier Beinen, die in zwei Höhen erhältlich sind.

Life - столик с деревянным каркасом, предусмотрен в трех вариантах: круглый на трех ножках и прямоугольный на четырех ножках в двух размерах.

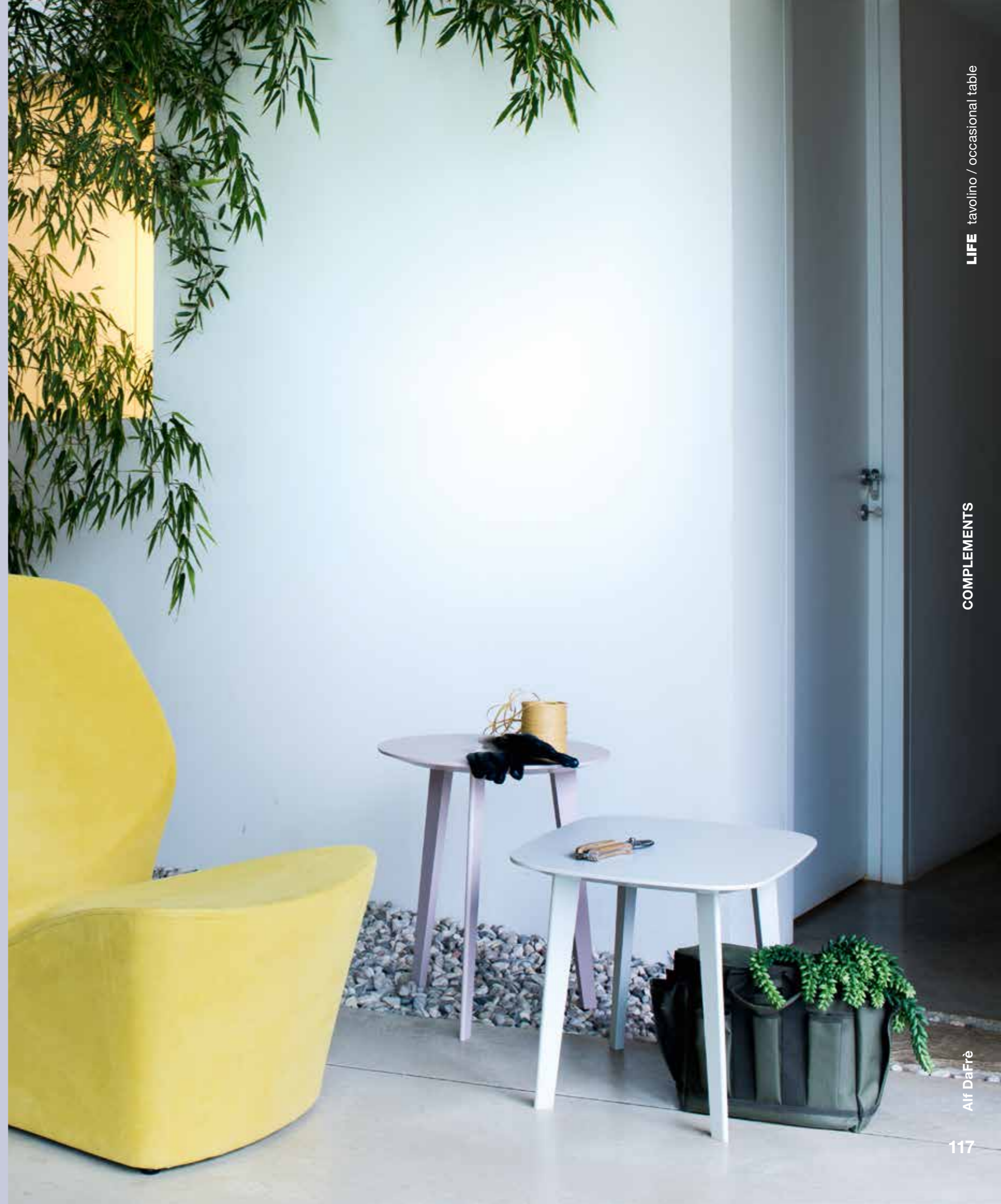



# Life

design **Haften Studio**

**Materiali e finiture**  
 Struttura:  
 Rovere termocotto / Fashion wood / Rovere colori opachi / Colori opachi  
 -

**Materials and finishes**  
 Structure:  
 Baked oak / Fashion wood / Oak matt colours / Matt colours  
 -

**Materiales y acabados**  
 Estructura:  
 Roble termotratado / Fashion wood / Roble teñido colores mate / Colores mate  
 -

**Matériaux et finitions**  
 Structure :  
 Chêne thermo-traité / Fashion Wood / Chêne laqué mat / Laqués mats  
 -

**Materialien und Ausführungen**  
 Korpus:  
 Thermo-Eiche / Fashion Wood / Eiche matte Farben / Matte Farben  
 -

**Материалы и варианты отделки**  
 Каркас:  
 Дуб термочотто / Fashion wood / Дуб матовых цветов / Матовые цвета

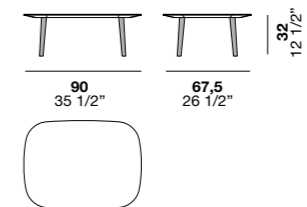
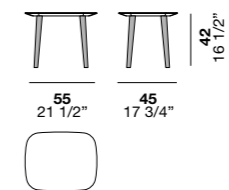
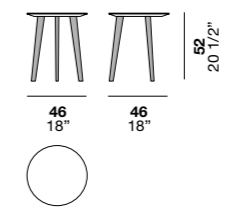

## MOCA

design R.D.A.

Moca è un tavolino rotondo con struttura in metallo verniciato e piano legno.  
Moca è disponibile in due misure.

**MOCA** tavolino / occasional table  
Struttura laccato Ghisa opaco,  
piano Fashion wood Rovere Terra /  
Structure in Matt Ghisa lacquered,  
top in Terra oak Fashion wood  
L60 P60 H45,5  
**WOK** tavolino / occasional table  
Laccato Anfora opaco /  
Matt Anfora lacquered  
L27,5 P27,5 H50

The Moca round occasional table has a painted metal structure and a wooden table top. Moca is available in two sizes.

Moca es una mesita redonda con estructura de metal barnizado y sobre de madera. Moca está disponible en dos tamaños.

Moca est une table basse ronde avec structure en métal verni et plateau en bois. Moca est disponible en deux dimensions.

Moca ist ein runder Beistelltisch mit einem Korpus aus lackiertem Metall und einer Platte aus Holz. Moca ist in zwei Größen erhältlich.

Моса - круглый столик с металлическим крашеным каркасом и деревянной столешницей. Моса предусмотрен в двух размерах.





**COPENAGHEN** divano / sofa  
 Tessuto Trento 04, Pelle Alfa 4270 /  
 Trento 04 fabric, Alfa 4270 leather L260 P91 H86  
**WOK** tavolino / occasional table  
 Laccato Anfora opaco /  
 Matt Anfora lacquered L27,5 P27,5 H50  
**MOCA** tavolino / occasional table  
 Struttura laccato Ghisa opaco, piano Fashion wood Rovere Terra /  
 Struttura in Matt Ghisa lacquered, top in Terra oak Fashion wood L60 P60 H45,4  
**MOCA** tavolino / occasional table  
 Laccato Modica opaco /  
 Matt Modica lacquered L90 P90 H37  
**TUFT** tavolino / occasional table  
 Struttura verniciato Rame brunito, piano Fashion wood Rovere Terra /  
 Struttura in Rame brunito painted, top in Terra oak Fashion wood L40,3 P40,3 H46,3





## Moca

design R.D.A.

### Materiali e finiture

Piano:  
Fashion wood / Rovere colori opachi / Colori opachi / Colori lucidi  
Struttura:  
Verniciato bianco / Verniciato moka shine / Colori opachi

### Materials and finishes

Top:  
Fashion wood / Oak matt colours / Matt colours / High gloss colours  
Structure:  
Bianco painted / moka shine painted / Matt colours

### Materiales y acabados

Sobre:  
Fashion wood / Roble teñido colores mate / Colores mate / Colores brillantes  
Estructura:  
Barnizado blanco / Barnizado moka shine / Colores mate

### Matériaux et finitions

Plateau :  
Fashion wood / Chêne laqué mat / Laqués mats / Laqués brillants  
Structure :  
Verni bianco / Verni moka shine / Laqués mats

### Materialien und Ausführungen

Platte:  
Fashion Wood / Eiche matte Farben / Matte Farben / Glänzende Farben  
Korpus:  
Lackiert Bianco / Lackiertes moka shine / Matte Farben

### Материалы и варианты отделки

Столешница:  
Fashion wood / Дуб матовых цветов / Матовые цвета / Глянцевые цвета  
Каркас:  
Крашенный bianco / Крашенный moka shine / Матовые цвета

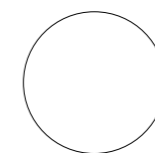
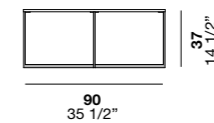
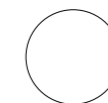
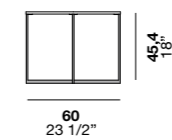



## NORMAN

design Haften Studio

Norman è un tavolino con struttura legno disponibile in versione quadrata o rettangolare. Il suo design si caratterizza per l'inserto piano in contrasto disponibile anche in resina cementizia.

**LADIGUE** divano / sofa  
Tessuto Mistral plain 01 /  
Mistral plain 01 fabric  
L294 P104 H74

**LADIGUE** divano / sofa  
Tessuto Mistral plain 03 /  
Mistral plain 03 fabric  
L254 P104 H74

**NORMAN** tavolino / occasional table  
Laccato Conchiglia opaco e lucido /  
Matt and high gloss Conchiglia lacquered  
L100 P100 H33,6

The Norman occasional table has a wooden structure and it is available in either the square or the rectangular version. Its design stands out for its contrasting top insert, which is also available in cement resin.

Norman es una mesita con estructura de madera, disponible en versión cuadrada o rectangular. Su diseño se caracteriza por el inserto del sobre en contraste, disponible también en resina de cemento.

Norman est une table basse avec structure en bois disponible dans la version carrée ou rectangulaire. Son design est caractérisé par l'insert du plateau en contraste, également disponible en résine ciment.

Norman ist ein Beistelltisch mit einem Korpus aus Holz und ist in einer quadratischen und in einer rechteckigen Version erhältlich. Sein Design zeichnet sich durch einen kontrastierenden Platteneinsatz aus; erhältlich auch in der Zementharz-Ausführung.

Norman - столик с деревянным каркасом, предусмотрен квадратной или прямоугольной формы. Его дизайн характеризуется контрастной вставкой столешницы, предусмотренной также в цементном композите.





**RECTA** madia / cabinet  
Laccato Juta opaco /  
Matt Juta lacquered L167 P49 H7160,5  
**NORMAN** tavolino / occasional table  
Rovere laccato opaco Platino, laccato Platino lucido /  
Matt laquered oak Platino, High gloss Platino lacquered L120 P70 H33,6  
**DENNY** pouf / pouf  
Tessuto Zeph 01 /  
Zeph 01 fabric L55 P55 H42  
**DENNY** pouf / pouf  
Tessuto Tennessee 11 /  
Tennessee 11 fabric L85 P85 H37  
**CALIFORNIA** divano / sofa  
Tessuto Zeph 12 /  
Zeph 12 fabric L316 P100 H84



**CALIFORNIA** divano / sofa  
Tessuto Wonderful 02 / Wonderful 02 fabric L438 P338 H84  
**NORMAN** tavolino / occasional table  
Laccato Arena opaco / Matt Arena lacquered L100 P100 H33,6  
**NORMAN** tavolino / occasional table  
Laccato Cipria opaco / Matt Cipria lacqueredlacquered L120 P70 H33,6  
**TUFT** tavolino / occasional table  
Laccato Ghisa opaco /Matt Ghisa lacquered L60,3 P60,3 H36,8



# Norman

design **Haften Studio**

## Materiali e finiture

Struttura:

Rovere termocotto / Fashion wood / Rovere colori opachi / Colori opachi / Colori lucidi

Inserto piano:

Rovere termocotto / Fashion wood / Rovere colori opachi / Colori opachi / Colori lucidi / Resine cementizie

-

## Materials and finishes

Structure:

Baked Oak / Fashion wood / Oak matt colours / Matt colours / High gloss colours

Top insert:

Baked oak / Fashion wood / Oak matt colours / Matt colours / High gloss colours / Cement resin.

-

## Materiales y acabados

Estructura:

Roble termotratado / Fashion wood / Roble teñido colores mate / Colores mate / Colores brillantes

Inserto del sobre:

Roble termotratado / Fashion wood / Roble teñido colores mate / Colores mate / Colores brillantes / Resinas de cemento

-

## Matériaux et finitions

Structure :

Chêne thermo-traité / Fashion Wood / Chêne laqué mat / Laqués mats / Laqués brillants

Insert plateau :

Chêne thermo-traité / Fashion wood / Chêne laqué mat / Laqués mats / Laqués brillants / Résine ciment

-

## Materialien und Ausführungen

Korpus:

Thermo-Eiche / Fashion Wood / Eiche matte Farben / Matte Farben / Glänzende Farben

Platteneinsatz:

Thermo-Eiche / Fashion Wood / Eiche matte Farben / Matte Farben / Glänzende Farben / Zementharze

-

## Материалы и варианты отделки

Каркас:

Дуб термодотто / Fashion wood / Дуб матовых цветов / Матовые цвета / Глянцевые цвета

Вставка столешницы:

Дуб термодотто / Fashion wood / Дуб матовых цветов / Матовые цвета / Глянцевые цвета / Цементный композит

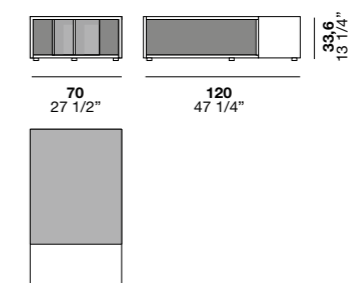
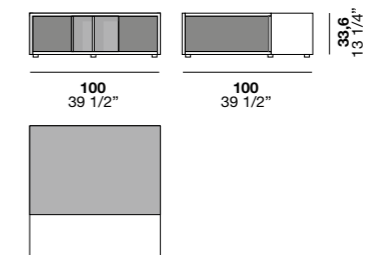

## RIM

design Enrico Cesana

Rim è un tavolino con anta o vano a giorno, di differenzia per la linea curva e le dimensioni compatte. La possibilità del bicolore ne esalta le linee e ne amplia la versatilità.

**JETTY** letto / bed  
Struttura metallo Elettrocol,  
Testiera Cuio 1004 /  
Structure in Elettrocol metal,  
Headboard in 1004 leather  
L174 P212,6 H94,5  
**RIM** tavolino / occasional table  
Laccato Piombo opaco,  
Laccato Ghiaia opaco /  
Matt Piombo lacquered,  
Matt Ghiaia lacquered  
L40 P40 H52

Rim is a table with either a door or open compartment. It stands out for its curved lines and compact size. The two-tone option brings out its shape and makes it a truly versatile piece.

Rim es una mesita con puerta o compartimento abierto que se caracteriza por sus formas curvas y dimensiones compactas. La variante bicolor disponible acentúa sus perfiles y la hace aún más versátil.

Rim est une table basse avec porte ou niche ouverte, elle se différencie pour sa ligne arrondie et ses dimensions compactes. La possibilité du bicolore en exalte les lignes et en augmente la versatilité.

Rim ist ein Beistelltisch mit Tür oder Offenfach, der sich durch seine abgerundeten und kompakten Formen auszeichnet. Die Zweifarbigkeit verstärkt seine Linienführung und macht ihn vielseitig einsetzbar.

Rim представляет собой столик с дверцей или с открытым отсеком, отличающийся изогнутой формой и компактными размерами. Возможность двухцветного решения подчеркивает линии и увеличивает его универсальность.





**ODETTE** poltrona / armchair  
 Tessuto St. Moritz 154 /  
 St. Moritz 154 fabric L60,3 P87,8 H87  
**RIM** tavolino / occasional table  
 Laccato Piombo opaco, Laccato Ghiaia opaco /  
 Matt Piombo lacquered, Matt Ghiaia lacquered L40 P40 H52





## Rim

design **Enrico Cesana**

### Materiali e finiture

Top, gola e ripiani: Rovere termocotto / Fashion wood /  
Rovere colori opachi / Laccati opachi  
Struttura esterna: Rovere termocotto / Fashion wood /  
Rovere colori opachi / Laccati opachi

### Materials and finishes

Top and groove: Rovere termocotto / Fashion wood /  
Oak matt lacquers / Matt lacquered  
External structure: Rovere termocotto / Fashion wood /  
Oak matt lacquers / Matt lacquered

### Materiales y acabados

Encimera y ranura: Rovere termocotto / Fashion wood /  
Robles lacados mate / Lacados mates  
Estructura externa: Rovere termocotto / Fashion wood /  
Robles lacados mate / Lacados mates

### Matériaux et finitions

Dessus et gorge: Rovere termocotto / Fashion wood /  
Chênes laqués mats / Laqués mats  
Structure externe: Rovere termocotto / Fashion wood /  
Chênes laqués mats / Laqués mats

### Materialien und Ausführungen

Platte und kehle: Rovere Termocotto / Fashion wood /  
Eiche matt lackiert / Matt lackiert  
Aussenkorpus: Rovere Termocotto / Fashion wood /  
Eiche matt lackiert / Matt lackiert

### Материалы и варианты отделки

Верхняя панель и gola: Rovere Termocotto / Fashion wood /  
Дуб крашенный матовый / Крашенный матовый  
Внешний каркас: Rovere Termocotto / Fashion wood / Дуб  
крашенный матовый / Крашенный матовый

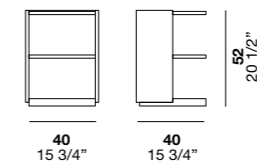
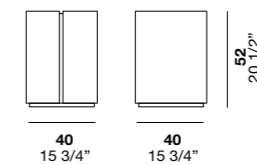

## TUFT

design Enrico Cesana

Tuft è un tavolino rotondo con struttura in metallo disponibile in 2 misure.

La parte superiore è realizzata come un “vassoio” a cui può essere abbinato un piano in legno.

**TUFT** tavolino / occasional table

Laccato Modica opaco /

Matt Modica lacquered

L40,3 P40,3 H46,3

**TUFT** tavolino / occasional table

Verniciato Rame brunito /

Rame brunito painted

L60,3 P60,3 H36,8

Tuft is a round occasional table with a metal structure available in 2 sizes. The top is made like a “tray”, which can be combined with a wooden surface.

Tuft es una mesita redonda con estructura de metal, disponible en 2 tamaños. La parte superior está realizada a modo de “bandeja” a la que se puede unir un sobre de madera.

Tuft est une table basse ronde avec structure en métal disponible en 2 dimensions. La partie supérieure est réalisée comme un “plateau” auquel peut être associé un plateau en bois.

Tuft ist ein runder Beistelltisch mit einem Korpus aus Metall und ist in zwei Größen erhältlich. Die Platte ist wie ein Tablett gearbeitet, das mit einer Holzplatte kombiniert werden kann.

Tuft - круглый столик с металлическим каркасом, предусмотрен в 2 размерах. Верхняя часть выполнена в виде “подноса”, с которым можно обеспечить сочетание деревянной столешницы.







**NOBEL** credenza / sideboard  
 Fashion wood Rovere Terra, basamento Moka shine /  
 Terra oak Fashion wood, Moka shine basement L256,5 P52,7 H68,4  
**COPENAGHEN** divano / sofa  
 Pelle Alfa 4270, basamento Moka shine /  
 4270 Alfa leather, Moka shine basement L260 P91 H86  
**TUFT** tavolino / occasional table  
 Verniciato Rame Brunito, Fashion wood Rovere Terra /  
 Rame Brunito painted, Fashion wood Rovere Terra L43 P43 H36,8



# Tuft

design **Enrico Cesana**

### Materiali e finiture

Struttura:  
Verniciato bianco / Verniciato moka shine / Verniciato rame  
brunito / Colori opachi  
Inserto piano:  
Rovere termocotto / Fashion wood / Colori opachi  
-

### Materials and finishes

Structure:  
Bianco painted / Moka shine painted / rame brunito pain-  
ted / Matt colours  
Top insert:  
Baked oak / Fashion wood / Matt colours  
-

### Materiales y acabados

Estructura:  
Barnizado blanco / Barnizado moka shine / Barnizado  
rame brunito / Colores mate  
Inserto del sobre:  
Roble termotratado / Fashion wood / Colores mate  
-

### Matériaux et finitions

Structure :  
Verni bianco / Verni moka shine / Verni rame brunito /  
Laqués mats  
Insert plateau :  
Chêne thermo-traité / Fashion wood / Laqués mats  
-

### Материалы и варианты отделки

Каркас:  
Крашенный bianco / Крашенный moka shine / Крашенный  
rame brunito / Матовые цвета  
Вставка столешницы:  
Дуб термодотто / Fashion wood / Матовые цвета

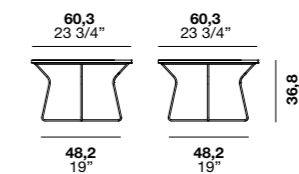
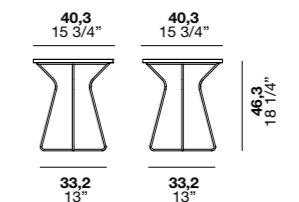
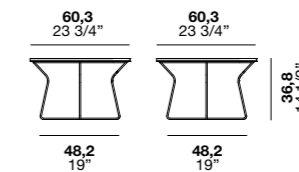
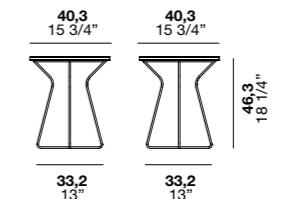

## WOK / WOK BOX

design Enrico Cesana

**Wok è un tavolino rotondo con struttura in metallo. Wok Box si differenzia per il contenitore legno nella parte superiore chiusa un coperchio che all'occorenza diventa un pratico vassoio con impugnatura sagomata.**

Wok is a round occasional table with a metal structure. Wok Box differs in that it has a wooden storage unit at the top, which is topped off by a cover that turns into a practical tray with a shaped handle when necessary.

Wok es una mesita redonda con estructura de metal. Wok Box se diferencia por el contenedor de madera, cerrado por arriba con una tapa que, cuando hace falta, se convierte en una cómoda bandeja con agarre conformado.

Wok est une table basse ronde avec structure en métal. Wok Box se différencie pour le module en bois sur la partie supérieure fermée avec un couvercle qui à l'occurrence devient un pratique plateau avec poignée galbée.

Wok ist ein runder Beistelltisch mit einem Korpus aus Metall. Wok Box bietet zudem eine Aufbewahrungsbox im oberen Teil des Tisches, welcher mit einer Platte verschlossen wird, die dank der eingearbeiteten Aussparung zu einem praktischen Tablett wird.

Wok - круглый столик с металлическим каркасом. Wok Box характеризуется деревянным контейнером в верхней части, закрытым крышкой, который при необходимости становится практичным подносом с профильной ручкой.



**WOK BOX** tavolino / occasional table  
Laccato Carta da zucchero e Fango opaco /  
Matt Carta da zucchero and Fango lacquered  
L35 P35 H43  
**JET SET** poltrona / armchair  
Tessuto Nina 27 /  
Nina 27 fabric L77 P87 H80  
**CEPPO** tavolino / occasional table  
Rovere /  
Oak L30 P30 H37/47

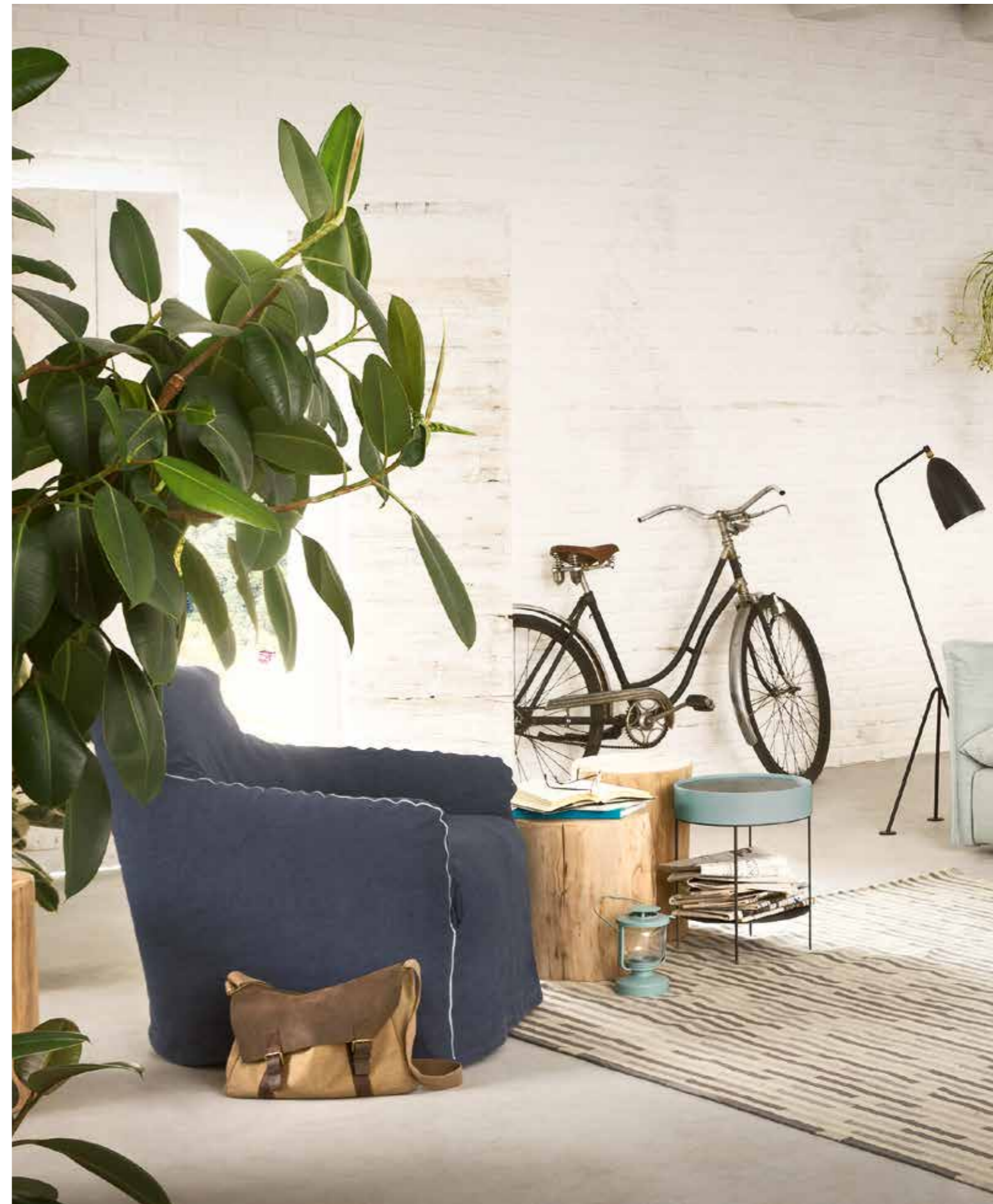

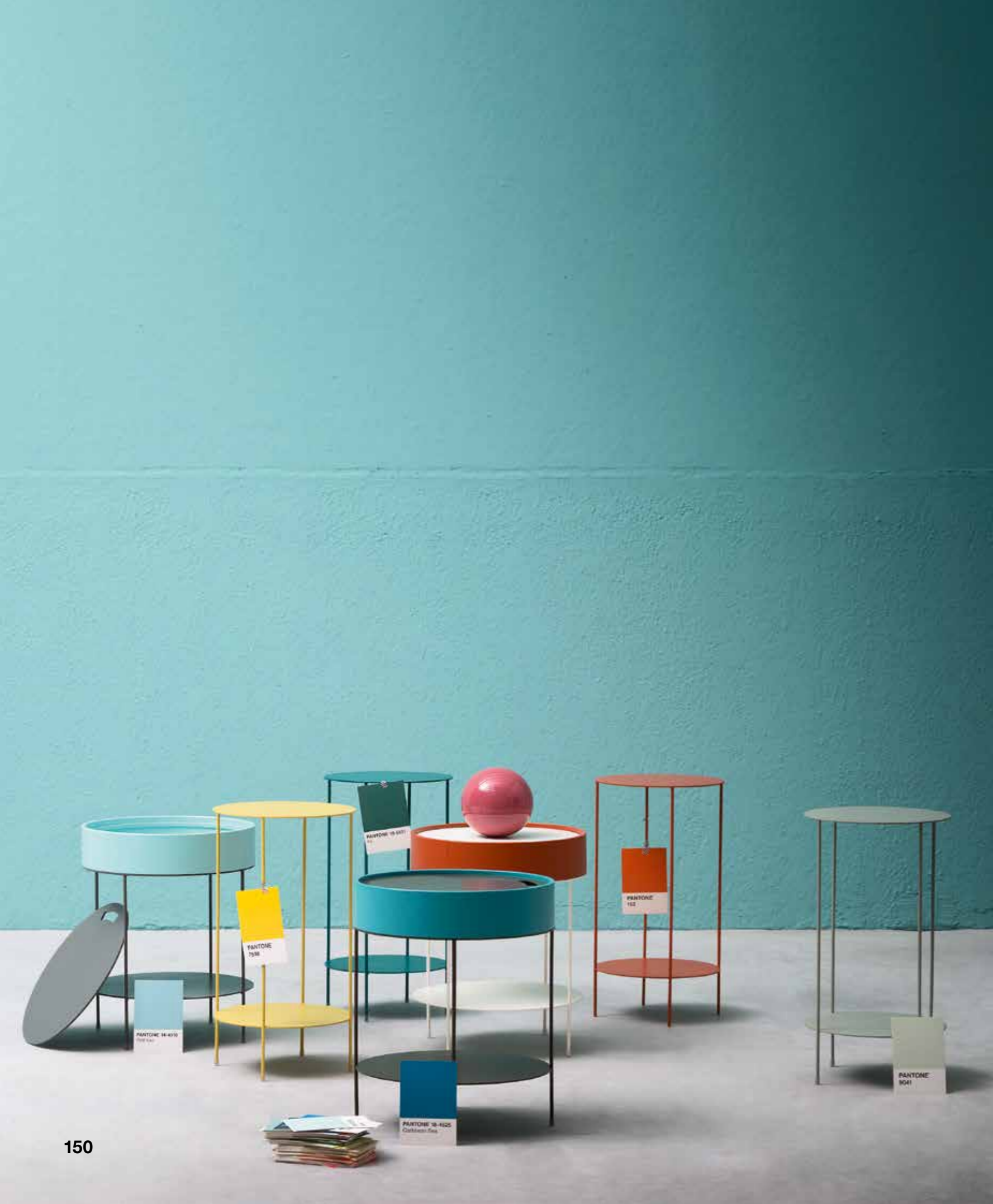

## Wok / Wok Box

design **Enrico Cesana**

### Materiali e finiture

Struttura:  
Verniciato bianco / Verniciato moka shine / Colori opachi  
Contenitore:  
Fashion wood / Rovere colori opachi / Colori opachi

### Materials and finishes

Structure:  
Bianco painted / moka shine painted / Matt colours  
Storage unit:  
Fashion wood / Oak matt colours / Matt colours

### Materiales y acabados

Estructura:  
Barnizado blanco / Barnizado moka shine / Colores mate  
Contenedor:  
Fashion wood / Roble teñido colores mate / Colores mate

### Matériaux et finitions

Structure :  
Verni bianco / Verni moka shine / Laqués mats  
Module :  
Fashion wood / Chêne laqué mat / Laqués mats

### Materialien und Ausführungen

Korpus:  
Lackiert Bianco / Lackiertes moka shine / Matte Farben  
Aufbewahrungsbox:  
Fashion Wood / Eiche matte Farben / Matte Farben

### Материалы и варианты отделки

Каркас:  
Крашенный bianco / Крашенный мoka shine / Матовые цвета  
Контейнер:  
Fashion wood / Дуб матовых цветов / Матовые цвета

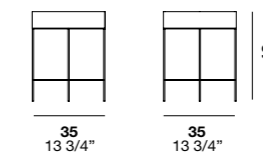
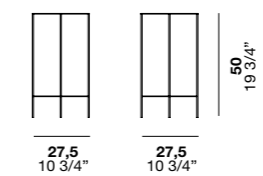

## tavoli

tables

---



**Aliante**  
pag. 154

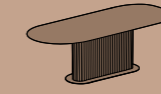

**Rigadin**  
pag. 292



**Board**  
pag. 162

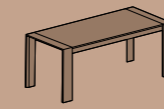

**Brera 2.0 / Brera Lux**  
pag. 172

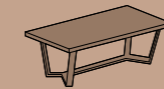

**Cartesio 2.0**  
pag. 178



**Cliff**  
pag. 186



**Jag**  
pag. 192



**Le 20**  
pag. 208

## ALIANTE

design Bruna Vaccher

**Aliante è un tavolo con struttura in metallo e piano quadrato o rettangolare, disponibile in versione fissa o allungabile.**

**Questo tavolo si caratterizza per la presenza di “calzini” legno, in diverse finiture abbinabili a proprio gusto ai laccati della parte superiore.**

**ALIANTE** tavolo / table  
Laccato Bianco opaco,  
calzini Fashion wood Rovere Canapa /  
Matt Bianco lacquered,  
feet in Canapa oak Fashion wood  
L200 P90 H73,5  
**ESEDRA** sedia /chair  
Struttura Fashion wood Rovere Canapa,  
seduta e schienale tessuto Smile 2 /  
Structure in Canapa oak Fashion wood,  
seat and back in Smile 2 fabric  
L50 P56 H84

The Aliante table has a metal structure and either a square or rectangular table top. It is available in a fixed or extensible model. This table catches the eye with its wooden 'socks', which can be finished to taste, to match the lacquer on the top part of the legs.

Aliante es una mesa con estructura de metal y sobre cuadrado o rectangular, disponible en versión fija o extensible. Esta mesa se caracteriza por incluir unos "calcetines" de madera, en diversos acabados que se pueden combinar libremente con los lacados de la parte superior.

Aliante est une table avec structure en métal et plateau carré ou rectangulaire, disponible dans la version fixe ou allongeable. Cette table est caractérisée par la présence de "chaussettes" en bois, en différentes finitions pouvant être associées selon le propre goût aux laqués de la partie supérieure.

Aliante ist ein Tisch mit einem Untergestell aus Metall und einer quadratischen oder rechteckigen Tischplatte, der in einer festen oder ausziehbaren Version erhältlich ist. Dieser Tisch trägt „Socken“ aus Holz, die in verschiedenen Ausführungen erhältlich sind und nach Belieben mit den lackierten Flächen des Tisches kombiniert werden können.

Aliante - это стол с металлической конструкцией и квадратной или прямоугольной столешницей, предлагается в раздвижном или нераздвижном варианте. Этот стол характеризуется нижними деревянными элементами в различных вариантах отделки, сочетаемыми с крашеной отделкой верхней части.



**ALIANTE** tavolo / table  
Laccato Platino opaco, calzini Fashion wood Rovere Carbone /  
Platino matt lacquered, feet in Carbone oak Fashion wood L200 P90 H73,5  
**CORIUM** sedia / chair  
Cuoio 1031 / 1031 leather L50,5 P55 H80/93



**ALIANTE** tavolo / table

**COMPLEMENTS**

Aif DaFrè



**ALIANTE** tavolo / table  
Laccato opaco Arena /  
Matt Arena lacquered L200 P90 H73,5  
**CORIUM** sedia / chair  
Rovere /  
Oak L30 P30 H47



**ALIANTE** tavolo / table

**COMPLEMENTS**

Aif DaFrè



# Aliante

design **Brunella Vaccher**

## Materiali e finiture

Piano: Nobilitato Bianco / colori opachi  
 opachi  
 Struttura: Metallo Verniciato bianco / Colori opachi

## Materials and finishes

Top: Bianco surfaced / matt colours  
 Structure: Bianco painted metal / matt colours

## Matériaux et finitions

Plateau : Mélangé Bianco / Laqués mats  
 Structure : Métal verni bianco / Laqués mats

## Materialien und Ausführungen

Platte: Melamin Bianco / matte Farben  
 Korpus: Metall lackiert Bianco / matte Farben

## Materiales y acabados

Sobre: Ennoblecido Bianco / Colores mate  
 Estructura: Barnizado blanco / Colores mate

## Материалы и варианты отделки

Столешница: Ламинированный Bianco / Матовые цвета  
 Каркас: Крашенный металл bianco / Матовые цвета



Colori opachi  
 Matt colours  
 Colores mate  
 Laqués mats  
 Matte Farben  
 Матовые цвета



Fashion wood  
 Fashion wood  
 Fashion wood  
 Fashion Wood  
 Fashion wood



Rovere colori opachi  
 Oak matt colours  
 Roble teñido colores mate  
 Chêne laqué mat  
 Eiche matte Farben  
 Дуб матовых цветов



Rovere termocotto  
 Baked oak  
 Roble termotratado  
 Chêne thermo-traité  
 Thermo-Eiche  
 Дуб термочотто

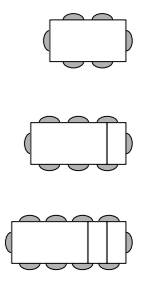
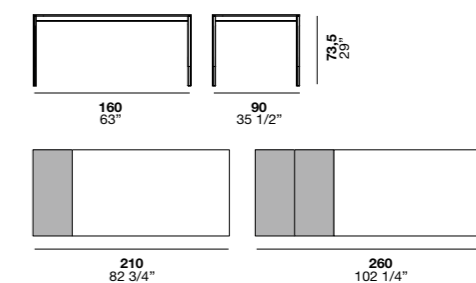
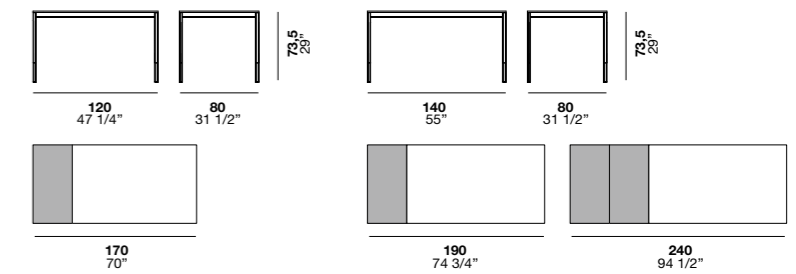
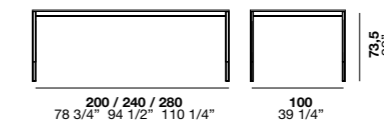
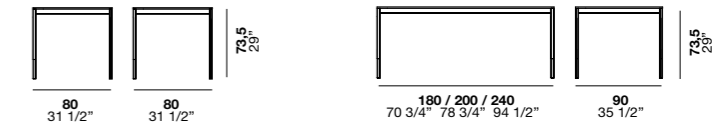

## BOARD

design R.D.A.

**Board è un tavolo con struttura metallo e piano legno, rettangolare, disponibile in versione fissa o allungabile.**

**Nel tavolo Board convivono alla perfezione un basamento in metallo verniciato di forma geometrica e un piano in rovere antico nodato disegnato da bordi con una sagomatura irregolare.**

Board is a rectangular table with a metal structure and a wooden table top, and it is available in the fixed or extending version. In the Board table, a geometrically shaped metal base finds the perfect partner in a knotted aged-look oak table top designed by irregular-shaped edges.

Board es una mesa con estructura de metal y sobre de madera rectangular, disponible en versión fija o extensible. En la mesa Board conviven en perfecta armonía una base de metal barnizado de forma geométrica y un sobre de roble envejecido con nudos, perfilado por cantos con un conformado irregular.

Board est une table avec structure en métal et plateau en bois, rectangulaire, disponible dans la version fixe ou allongeable. Sur la table Board cohabitent à la perfection un piètement en métal verni à la forme géométrique et un plateau en chêne vieilli à nœuds dessiné par des bords avec un façonnage irrégulier.

Board ist ein Tisch mit Metallkorpus und einer rechteckigen Holzplatte, der in einer festen und in einer ausziehbaren Version erhältlich ist. Der Tisch Board vereint auf perfekte Weise ein Untergestell aus lackiertem Metall mit stark geometrischen Formen mit einer Tischplatte aus antiker Eiche mit Asteschlüssen und Rändern, die der Platte eine unregelmäßige Form geben.

Board - стол с металлическим каркасом и деревянной столешницей, прямоугольный, фиксированный или раздвижной. В столе Board превосходно сочетается основание из крашеного металла геометрической формы и столешница из античного дуба, характеризующаяся кромкой и неправильным профилем.





**BOARD** tavolo / table  
Struttura verniciato Ghisa, piano Rovere antico Fossile /  
Structure in Ghisa painted, top in Fossile aged oak L200 P100 H75  
**AILERON** sedia / chair  
Struttura Laccato Platino opaco, seduta e schienale tessuto Smile 21 /  
Structure in Matt Platino lacquered, seat and back in Smile 21 fabric L45,5 P53 H78





**BOARD** tavolo / table  
 Struttura verniciato Ghisa, piano Rovere antico Biscotto /  
 Structure in Ghisa painted, top in Antique walnut Biscotto L240 P100 H75  
**KAROL WOOD** sedia / chair  
 Ecopelle Alice 240 , gambe Fashion wood Rovere Biscotto /  
 Alice 240 ecoleather, legs in Biscotto oak Fashion wood L50 P62 H80  
**RECTA** credenza / sideboard  
 Laccato Ghisa opaco, Rovere antico Biscotto /  
 Matt Ghisa lacquered, Antique walnut Biscotto L246,8 P55 H78,2

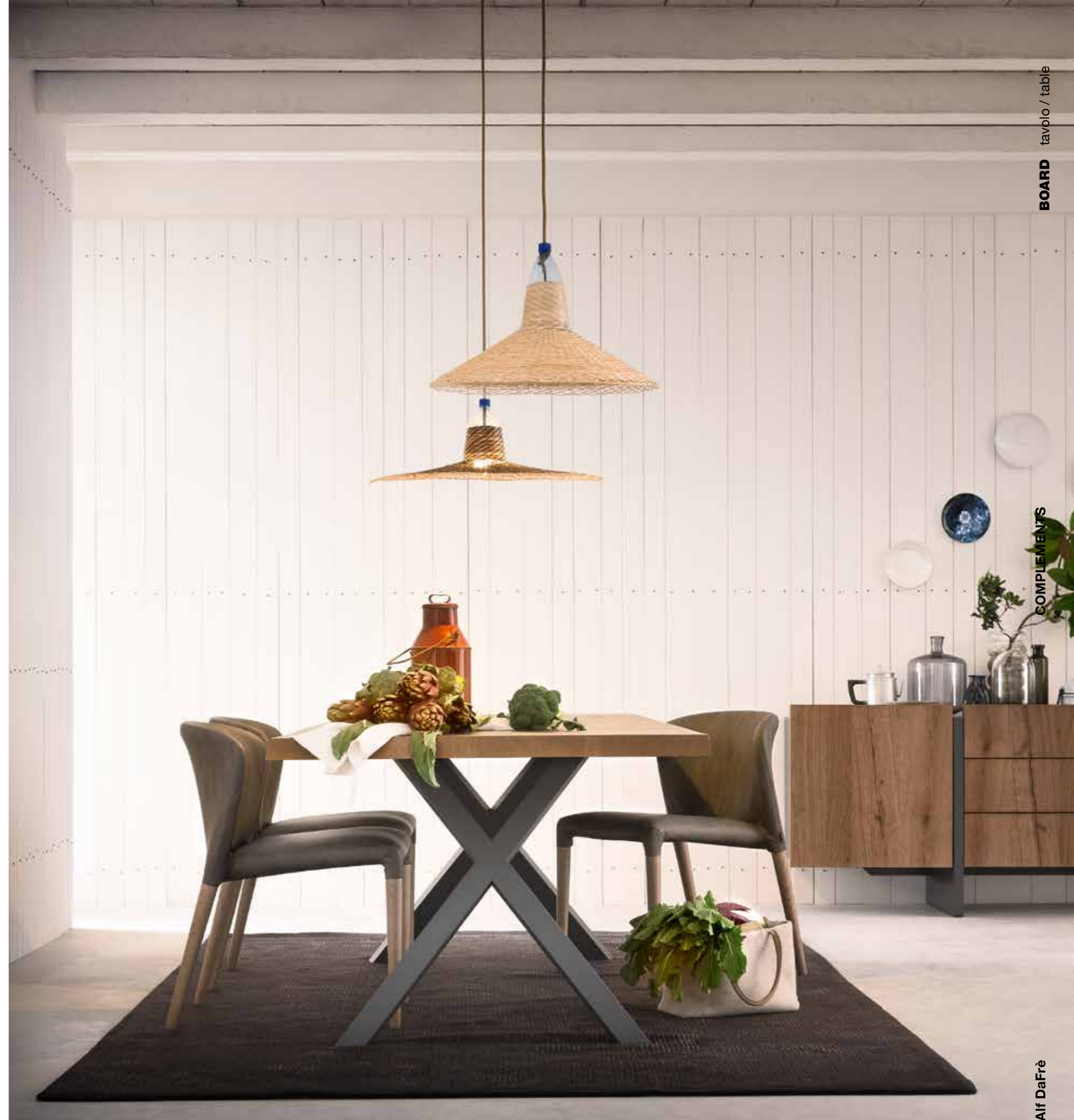



# Board

design R.D.A.

## Materiali e finiture

Piano:  
Rovere antico  
Struttura:  
Verniciato ghisa

## Materials and finishes

Top:  
Aged-look oak  
Structure:  
Ghisa painted

## Materiales y acabados

Sobre:  
Roble envejecido  
Estructura:  
Barnizado ghisa

## Matériaux et finitions

Plateau :  
Chêne vieilli  
Structure :  
Verni ghisa

## Materialien und Ausführungen

Platte:  
Eiche Antik  
Korpus:  
Lackiertes Gusseisen

## Материалы и варианты отделки

Столешница:  
Античный дуб  
Каркас:  
Крашенный ghisa

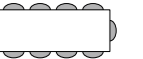
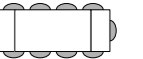
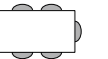
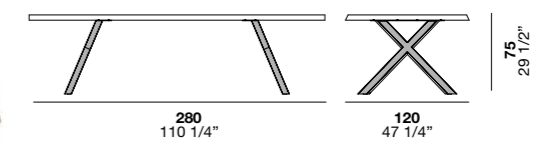
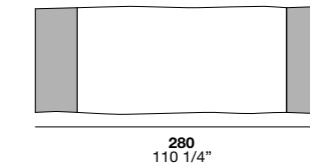
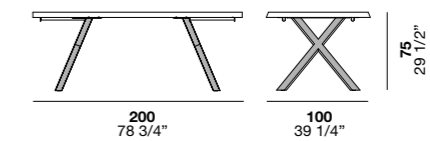
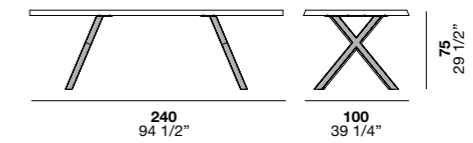
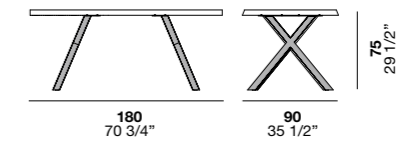

COMPLEMENTS

Aif DaFrè

/technical data

## BRERA 2.0 / BRERA LUX

design Haften Studio

Brera è un tavolo con struttura e piano in legno (Brera 2.0) o struttura in legno e piano vetro (Brera Lux), quadrato o rettangolare, disponibile in versione fissa o allungabile. In questo tavolo il design delle gambe prosegue nel piano creando un effetto di continuità.

The Brera table has a wooden structure and table top (Brera 2.0) or a wooden structure and glass top (Brera Lux), either square or rectangular, and it is available in the fixed or extending version. In this table, the leg design continues in the table top, creating a seamless effect.

Brera es una mesa con estructura y sobre de madera (Brera 2.0) o estructura de madera y sobre de cristal (Brera Lux), cuadrado o rectangular, disponible en versión fija o extensible. En esta mesa, el diseño de las patas se reproduce en el sobre, creando un efecto de continuidad.

Brera est une table avec structure et plateau en bois (Brera 2.0) ou structure en bois et plateau en verre (Brera Lux), carrée ou rectangulaire, disponible dans la version fixe ou allongeable. Sur cette table, le design des pieds continue sur le plateau créant ainsi un effet de continuité.

Brera ist ein quadratischer oder rechteckiger Tisch mit Korpus und Tischplatte aus Holz (Brera 2.0) oder Holzkorpus und Tischplatte aus Glas (Brera Lux), der in einer festen oder in einer ausziehbaren Version erhältlich ist. Bei diesem Tisch setzt sich die Form der Beine in der Tischplatte fort und schafft so ein durchgehendes Design.

Brera - стол с деревянным каркасом и столешницей (Brera 2.0) или с деревянным каркасом и стеклянной столешницей (Brera Lux), квадратный или прямоугольный, предусмотрен как в фиксированном, так и в раздвижном варианте. В этом столе дизайн ножек продолжается в столешнице, создавая эффект непрерывности.







**METROPOLIS** madia / cabinet  
 Fashion wood Rovere Canapa, vano vetro Decor laccato Sahara /  
 Canapa oak Fashion wood, glass compartment in Decor Sahara lacquered L128 P52,2 H136  
**BRERA** tavolo / table  
 Laccato Pino opaco /  
 Matt Pino lacquered L260 P90 H75  
**VIKY2** sedia / chair  
 Struttura Fashion wood Rovere Canapa, seduta e schienale tessuto Grano 02 /  
 Structure in Canapa oak Fashion wood, seat and back in Grano 02 Fabric L59 P52 H70



## Brera 2.0 / Brera Lux

design **Haften Studio**

### Materiali e finiture

Struttura:  
Fashion wood / Rovere colori opachi / Colori opachi  
Piano (Brera Lux):  
Vetri colori lucidi  
-

### Materials and finishes

Structure:  
Fashion wood / Oak matt colours / Matt colours  
Table top (Brera Lux):  
High gloss coloured glass  
-

### Materiales y acabados

Estructura:  
Fashion wood / Roble teñido colores mate / Colores mate  
Sobre (Brera Lux):  
Cristales colores brillantes  
-

### Matériaux et finitions

Structure :  
Fashion wood / Chêne laqué mat / Laqués mats  
Plateau (Brera Lux):  
Verres laqués brillants  
-

### Materialien und Ausführungen

Korpus:  
Fashion Wood / Eiche matte Farben / Matte Farben  
Platte (Brera Lux):  
Glasplatten glänzende Farben  
-

### Материалы и варианты отделки

Каркас:  
Fashion wood / Дуб матовых цветов / Матовые цвета  
Столешница (Brera Lux):  
Стекла глянцевых цветов  
-



### Brera Lux

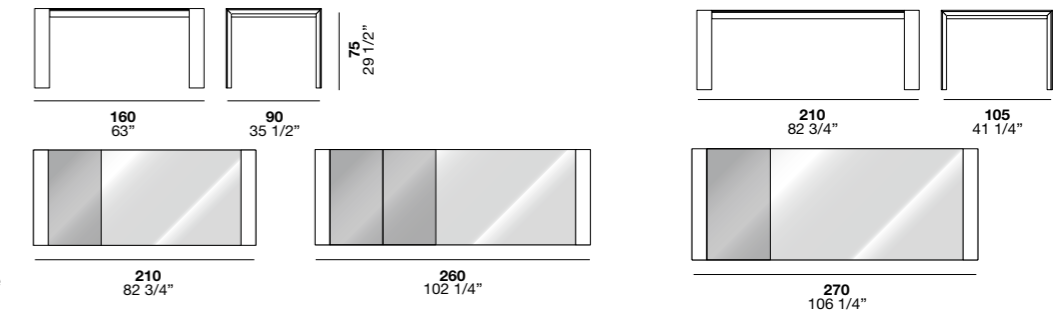

### Brera 2.0

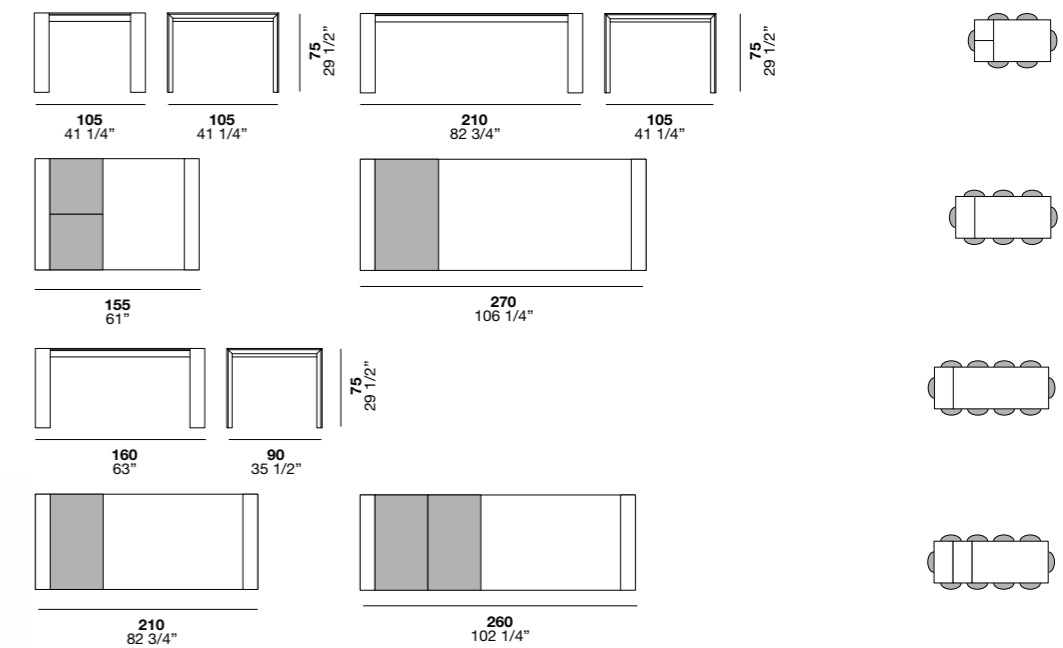

## CARTESIO 2.0

design Haften Studio

**Cartesio 2.0 è un tavolo con struttura in legno, rettangolare e allungabile.**

**Cartesio 2.0 si distingue per il piano e le allunghe di forte spessore e per la particolare conformazione del basamento in cui le gambe inclinate si collegano nella parte inferiore creando una “struttura chiusa”.**

The Cartesio 2.0 table has a wooden structure, and it is either square or rectangular. Cartesio 2.0 stands out for the extra thick table top and extensions and for the particular shape of the base, with tilted legs that join at the bottom to form a “closed structure”.

Cartesio 2.0 es una mesa con estructura de madera, rectangular y extensible. Cartesio 2.0 se distingue por el sobre y las extensiones de gran espesor y por la particular conformación de la base, en la que las patas inclinadas se unen en la parte inferior, creando una “estructura cerrada”.

Cartesio 2.0 est une table avec structure en bois, rectangulaire et allongeable. Cartesio 2.0 se distingue pour le plateau et les allonges épaisses et pour la particulière conformation du piétement sur lequel les pieds inclinés se relient sur la partie inférieure en créant une “structure fermée”.

Cartesio 2.0 ist ein rechteckiger und ausziehbarer Tisch mit Holzkorpus. Cartesio 2.0 bietet eine Platte und Tischverlängerungen mit einer besonders massiven Stärke und glänzt mit einer ungewöhnlichen Form des Untergestells, dessen angeschrägte Beinen sich am Boden zu einem durchgehenden Tischfuß vereinen.

Cartesio 2.0 - прямоугольный и раздвижной стол с деревянным каркасом. Cartesio 2.0 характеризуется столешницей и вставками значительной толщины, а также особым вариантом основания, в котором наклонные ножки соединяются в нижней части, образуя “закрытую структуру”.





**CARTESIO 2.0** tavolo / table  
Fashion wood rovere Carbone /  
Carbone oak Fashion wood L220 P100 H74  
**CORIUM** sedia / chair  
Cuio naturale / Natural leather L50,5 P55 H80



**CARTESIO 2.0** tavolo / table  
 Fashion wood rovere Carbone /  
 Carbone oak Fashion wood L220 P100 H74  
**CORIUM** sedia / chair  
 Fashion wood rovere Carbone /  
 Carbone oak Fashion wood L50,5 P55 H80





## Cartesio 2.0

design **Haften Studio**

### Materiali e finiture

Struttura:  
Fashion wood / Rovere colori opachi

### Materials and finishes

Structure:  
Fashion wood / Oak matt colours

### Materiales y acabados

Estructura:  
Fashion wood / Roble teñido colores mate

### Matériaux et finitions

Structure :  
Fashion wood / Chêne laqué mat

### Materialien und Ausführungen

Korpus:  
Fashion Wood / Eiche matte Farben

### Материалы и варианты отделки

Каркас:  
Fashion wood / Дуб матовых цветов

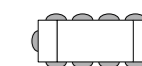
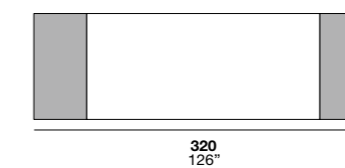
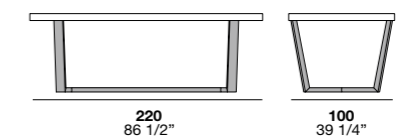
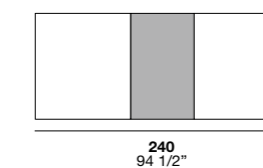
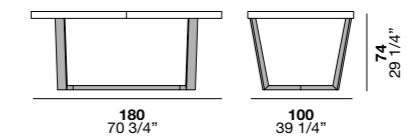

## CLIFF

design Haften Studio

Cliff è un tavolo con struttura in legno, quadrato o rettangolare, disponibile in versione fissa o allungabile.

La forma del piano è caratterizzata dal particolare taglio degli angoli in raccordo con la sfaccettatura delle gambe ripresa con coerenza nelle allunghe.

**CLIFF** tavolo / table  
Struttura laccato Piombo opaco,  
piano Fashion wood Rovere Terra /  
Structure in Matt Piombo  
lacquered, top in Terra oak  
Fashion wood  
L180 P95 H75,4  
**CORIUM** sedia / chair  
Cuoio naturale /  
Natural leather L50,5 P55 H80

The Cliff table has a wooden structure, either square or rectangular, and it is available in the fixed or extending version. The table top shape stands out for the particular cut of each corner, which is entirely in keeping with the faceting of the legs, matched in the extensions for perfect cohesion.

Cliff es una mesa con estructura de madera, cuadrada o rectangular, disponible en versión fija o extensible. La forma del sobre se caracteriza por el particular corte de las esquinas, que sigue la sección biselada de las patas, reproducida con coherencia en las extensiones.

Cliff est une table avec structure en bois, carrée ou rectangulaire, disponible dans la version fixe ou allongeable. La forme du plateau est caractérisée par la découpe particulière des angles raccordés aux facettes des pieds reprises avec cohérence sur les allonges.

Cliff ist ein quadratischer oder rechteckiger Tisch mit Holzkorpus, der in einer festen oder in einer ausziehbaren Version erhältlich ist. Die Form der Tischplatte zeichnet sich durch den außergewöhnliche Form der Ecken aus, die sich in der Form der Beine fortsetzt. Ein Detail, das auch in den Tischverlängerungen aufgenommen wird.

Cliff - стол с деревянным каркасом, квадратный или прямоугольный, фиксированный или раздвижной. Форма столешницы характеризуется особым вырезом угловых элементов, соединяющихся с граниением ножек, подчеркиваемым также во вставках.





**CLIFF** tavolo / table  
 Fashion wood Rovere Terra /  
 Terra oak Fashion wood L145 P145 H75,4  
**ELEKTA** sedia / chair  
 Struttura Fashion wood Rovere Terra, seduta e schienale in tessuto Ranger 2 /  
 Terra oak Fashion wood, seat and back in Ranger 2 fabric L46,3 P52 H80,4





# Cliff

design **Haften Studio**

### Materiali e finiture

Piano: Rovere termocotto / Fashion wood / Rovere colori opachi / Colori opachi / Colori lucidi / Resine cementizie.  
 Struttura: Rovere termocotto / Fashion wood / Rovere colori opachi / Colori opachi / Colori lucidi.

### Materials and finishes

Table top: Baked oak / Fashion wood / Oak matt colours / Matt colours / High gloss colours / Cement resin.  
 Structure: Baked Oak / Fashion wood / Oak matt colours / Matt colours / High gloss colours

### Materiales y acabados

Sobre: Roble termotratado / Fashion wood / Roble teñido colores mate / Colores mate / Colores brillantes / Resinas de cemento  
 Estructura: Roble termotratado / Fashion wood / Roble teñido colores mate / Colores mate / Colores brillantes.

### Matériaux et finitions

Plateau : Chêne thermo-traité / Fashion wood / Chêne laqué mat / Laqués mats / Laqués brillants / Résine ciment.  
 Structure : Chêne thermo-traité / Fashion wood / Chêne laqué mat / Laqués mats / Laqués brillants.

### Materialien und Ausführungen

Platte: Thermo-Eiche / Fashion Wood / Eiche matte Farben / Matte Farben / Glänzende Farben / Zementharze.  
 Korpus: Thermo-Eiche / Fashion Wood / Eiche matte Farben / Matte Farben / Glänzende Farben.

### Материалы и варианты отделки

Столешница: Дуб термокотто / Fashion wood / Дуб матовых цветов / Матовые цвета / Глянцевые цвета / Цементный композит.  
 Каркас: Дуб термокотто / Fashion wood / Дуб матовых цветов / Матовые цвета / Глянцевые цвета.

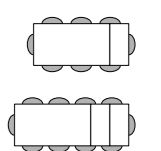
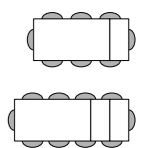
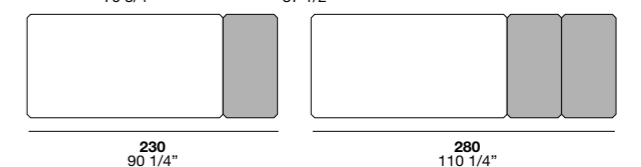
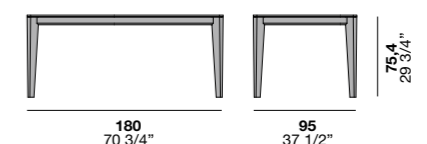
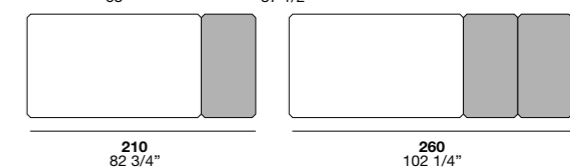
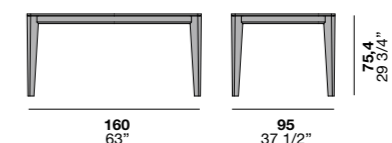
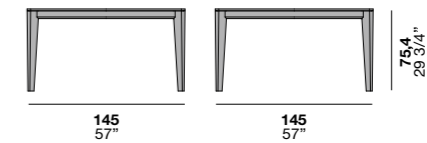

COMPLEMENTS

Aif DaFrè

/technical data

## JAG

design Haften Studio

**Jag è un tavolo con struttura in metallo verniciato e piano legno, quadrato o rettangolare, disponibile in versione fissa o allungabile.**

**Il piano dalla particolare conformazione “dogata” disponibile in diverse finiture può essere abbinato ai laccati del basamento.**

The Jag table has a painted metal structure and a wooden table top, either square or rectangular, and it is available in the fixed or extending version. The special “slatted” look of the table top, which is available in various finishes, can be combined with different colour lacquers for the base.

Jag es una mesa con estructura de metal barnizado y sobre de madera, cuadrado o rectangular, disponible en versión fija o extensible. El sobre, que tiene una particular conformación “alstonada”, está disponible en diversos acabados y puede combinarse con los lacados de la base.

Jag est une table avec structure en métal verni et plateau en bois, rectangulaire, disponible dans la version fixe ou allongeable. Le plateau à la particulière conformation “lambrissée” disponible en différentes finitions peut être associé aux laqués du piètement.

Jag ist ein Tisch mit einem Untergestell aus lackiertem Metall und einer quadratischen oder rechteckigen Tischplatte aus Holz, der in einer festen oder ausziehbaren Version erhältlich ist. Die Dauben-Tischplatte ist in verschiedenen Ausführungen erhältlich und kann auf die Lackierungen des Untergestells abgestimmt werden.

Jag - стол с металлической крашеной структурой и деревянной столешницей, квадратный или прямоугольный, фиксированный или раздвижной. Столешница характеризуется особой “реечной” структурой в различных вариантах отделки, может превосходно сочетаться с крашеной отделкой основания.





**JAG** tavolo / table  
Struttura verniciato nero trasparente lucido, piano Fashion wood Rovere Biscotto /  
Structure in Gloss black transparent painted, top Biscotto oak Fashion wood L140 P140,4 H75  
**VIKY** sedia / chair  
Struttura Fashion wood Rovere Biscotto, seduta e schienale tessuto Mistral plain 11 /  
Structure in Biscotto oak Fashion wood, seat and back in Mistral plain 11 fabric L59 P52 H76,5  
**DOMINO** elementi / elements  
Laccato Ghisa opaco /  
Matt Ghisa lacquered L384 P34,4 H32 / L96 P34,4 H272



# Jag

design **Haften Studio**

### Materiali e finiture

Piano: Nobilitato / Fashion wood / Rovere colori opachi / Colori opachi.  
 Struttura: Verniciato bianco / Verniciato titanio / Verniciato nero trasparente lucido / Colori opachi.

### Materials and finishes

Table top: Surfaced / Fashion wood / Oak matt colours / Matt colours.  
 Structure: Bianco painted / Titanium painted / High gloss transparent nero painted / Matt colours.

### Materiales y acabados

Sobre: Ennoblecido / Fashion wood / Roble teñido colores mate / Colores mate.  
 Estructura: Barnizado blanco / Barnizado titanio / Barnizado nero transparente brillante / Colores mate.

### Matériaux et finitions

Plateau : Mèlaminé / Fashion wood / Chêne laqué mat / Laqués mats.  
 Structure : Verni bianco / Verni titanio / Verni nero transparent brillant / Laqués mats.

### Materialien und Ausführungen

Platte: Melamin / Fashion Wood / Eiche matte Farben / Matte Farben.  
 Korpus: Lackiert Bianco / Lackiert Titanio / Lackiert Nero transparent glänzend / Matte Farben.

### Материалы и варианты отделки

Столешница: Ламинированный / Fashion wood / Дуб матовых цветов / Матовые цвета. Каркас: Крашенный bianco / Крашенный titanio / Крашенный nero прозрачный глянцевый / Матовые цвета.

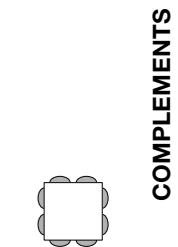
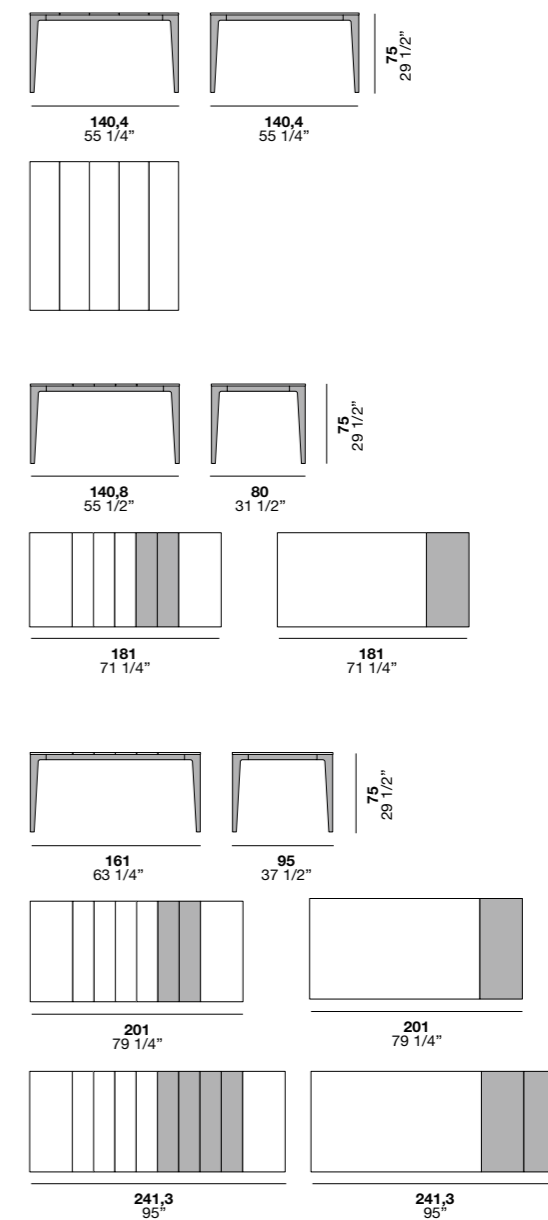

COMPLEMENTS

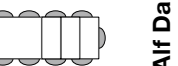
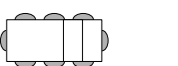
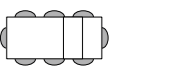

Aif DaFrè

## LE 20

design Bruna Vaccher

Le 20 è un tavolo con struttura legno di forma rotonda disponibile in due misure. Le gambe inclinate sorreggono il piano in cui un gioco grafico dà vita ad un orologio che segna le otto di sera.

Le 20 is a table with a round wooden structure and it is available in two sizes. The tilted legs support the table top, where a graphic game takes the shape of a clock set at eight o'clock in the evening.

Le 20 es una mesa con estructura de madera de forma redonda disponible en dos tamaños. Las patas inclinadas sostienen el sobre, donde un juego gráfico da vida a un reloj que marca las ocho de la tarde.

Le 20 est une table avec structure en bois de forme ronde disponible en deux dimensions. Les pieds inclinés soutiennent le plateau sur lequel un jeu graphique donne naissance à une horloge indiquant huit heures du soir.

Le 20 ist ein runder Tisch mit Korpus aus Holz, der in zwei Größen erhältlich ist. Die schrägen Beine tragen die runde Tischplatte, auf der eine Uhr abgebildet ist, die 8 Uhr abends anzeigt.

Le 20 - стол с деревянным каркасом закругленной формы, предусмотрен в двух размерах. Столешница опирается на наклонные ножки, где игра графики создает образ часов с указанием на восемь часов вечера.





**LE20** tavolo / table  
 Rovere laccato Platino opaco /  
 Matt Platino lacquered oak L125 P125 H73  
**CORIUM** sedia / chair  
 Cuoio 1031 /  
 1031 leather L50,5 P55 H80  
**CARTALEGNO** credenza / sideboard  
 Full-colour Grigio /  
 Grigio Full-colour L180,5 P50,5 H75,5





**LE20** tavolo / table  
 Fashion wood Rovere Canapa L140 P140 H73  
**KARINA** sedia / chair  
 Tessuto Nina 55 /  
 Nina 55 fabric L45,5 P53 H81  
**CEPPO** tavolino / occasional table  
 Rovere / Oak L30 P30 H37/47



## Le 20

design **Bruna Vaccher**

### Materiali e finiture

Piano:  
Fashion wood / Rovere colori opachi / Colori opachi  
Struttura:  
Fashion wood / Rovere colori opachi / Colori opachi

### Materials and finishes

Top:  
Fashion wood / Oak matt colours / Matt colours  
Structure:  
Fashion wood / Oak matt colours / Matt colours

### Materiales y acabados

Sobre:  
Fashion wood / Roble teñido colores mate / Colores mate  
Estructura:  
Fashion wood / Roble teñido colores mate / Colores mate

### Matériaux et finitions

Plateau :  
Fashion wood / Chêne laqué mat / Laqués mats  
Structure :  
Fashion wood / Chêne laqué mat / Laqués mats

### Materialien und Ausführungen

Platte:  
Fashion Wood / Eiche matte Farben / Matte Farben  
Korpus:  
Fashion Wood / Eiche matte Farben / Matte Farben

### Материалы и варианты отделки

Столешница:  
Fashion wood / Дуб матовых цветов / Матовые цвета  
Каркас:  
Fashion wood / Дуб матовых цветов / Матовые цвета

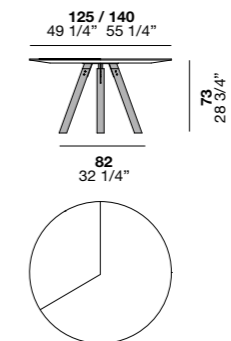



## RIGADIN

design Gordon Guillaumier

**Il legno massello è l'essenza di Rigadin. Una collezione preziosa e vera, dove la bellezza è forma ma anche sostanza. Pregio ed essenzialità sono plasmati in modo personale, connessi da ispirazione e artigianalità. Disponibile in versione con top metallo o marmo / pietra**

Solid wood is at the heart of Rigadin, an authentic high-value collection. Here, beauty is in the substance, as well as the form. High quality and simplicity are shaped to create a personalised end result, connected through inspiration and craftsmanship. Available with a metal or marble/stone top

La madera maciza es la esencia de Rigadin. Una colección hermosa y genuina, en la que la belleza es forma y sustancia al mismo tiempo. La calidad y la sobriedad se plasman de manera personal, unidas por la inspiración y la elaboración artesanal. Disponible en versión con sobre de metal o mármol/piedra

Le bois massif est l'essence de Rigadin. Une collection précieuse et vraie, où la beauté est forme mais aussi substance. La qualité et l'essentiel sont façonnés de manière personnelle, liés entre eux par l'inspiration et l'artisanat. Disponible dans la version avec dessus en métal ou marbre / pierre

Die Seele von Rigadin: Massivholz Eine edle und authentische Kollektion, in der Schönheit Form und Substanz annimmt. Edle Materialien und essentielle Eleganz erhalten durch Inspiration und handwerkliches Können eine ganz persönliche Form. Erhältlich in der Version mit Tischplatte aus Metall oder Marmor / Stein

Использование массива дерева является сутью коллекции Rigadin. Настоящая замечательная коллекция, где красота - это и форма, и сущность. Качество и чистота форм воплощены оригинальным образом и соединены с вдохновением и мастерством. Предлагается в варианте с металлической или мраморной / каменной столешницей





**RIGADIN** tavolo / table  
 Top metallo /  
 metal top L250 P105 H74  
**RIGADIN** credenza / sideboard  
 Top marmo Marron emperador lucido /  
 Gloss Marron emperador marble top L192,1 P47,6 H72,1  
**KAROL** sedia / chair  
 Pelle Alfa 4190 /  
 4190 Alfa leather L50 P62 H80







# Rigadin

design **Gordon Guillaumier**



Marmo Marron Emperador spazzolato / Brushed Emperador Marron Marble



Marmo Marron Emperador lucido / Glossy Emperador Marron Marble

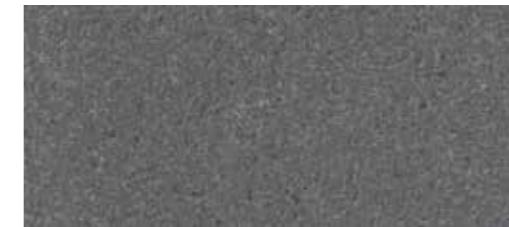

Pietra lavica spazzolata / Brushed lava stone

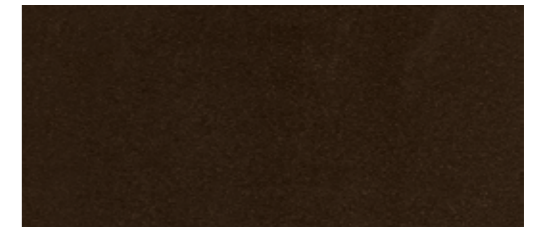

Elettrocol raggrinzante / Textured "Elettrocol"

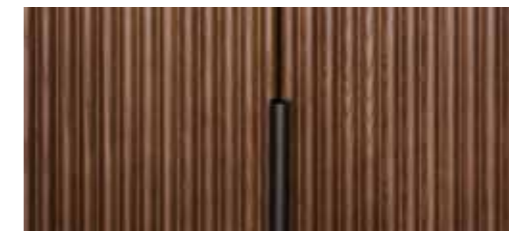

Frassino tinto noce / Walnut tinted ash

### Materiali e finiture

Piano: Marmo / Pietra / Metallo verniciato elettrocol raggrinzante  
 Basamento: Frassino tinto noce

### Materials and finishes

Top: textured "Elettrocol" painted metal / marble or stone  
 Base: Walnut tinted ash

### Materials and finishes

Sobre: Metal barnizado elettrocol rugoso / mármol o piedra  
 Base: Fresno teñida nogal

### Materiales y acabados

Dessus: Métal verni elettrocol ridé / marbre ou pierre  
 Piètement: Frêne teinte noyer

### Materialien und Ausführungen

Abdeckplatte aus Metall gerunzelt elektrolackiert / Marmor oder Stein  
 Untergestell: Esche Farbe Nussbaum

### Материалы и варианты отделки

Столешница из окрашенного рифленого металла elettrocol / из мрамора или камня  
 Основание из ясеня цвета орех

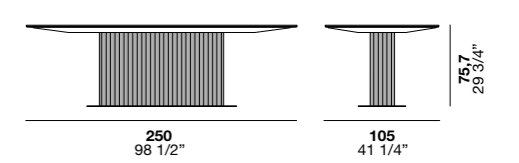
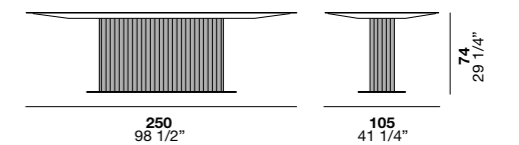

**sedie  
poltroncine**

chairs  
armchairs

---



**Aileron**  
pag. 216



**Corium**  
pag. 222



**Elekta**  
pag. 230



**Esedra**  
pag. 234



**Karina**  
pag. 240



**Karol / Karol Wood**  
pag. 246



**Viky**  
pag. 254

## AILERON

design Giulio Iacchetti

La sedia Aileron introduce nel mondo domestico, una soluzione tipica delle sedute ergonomiche da ufficio, ovvero un movimento dello schienale che, inclinandosi dolcemente, asseconda naturalmente il movimento della schiena in appoggio. Il meccanismo, assai semplice e minimale.

**AILERON** sedia / chair  
Struttura Laccato Ceruleo opaco,  
seduta e schienale tessuto Smile 31 /  
Structure in Matt Ceruleo lacquered,  
seat and back in Smile 31 fabric  
L45,5 P53 H78  
**AILERON** sedia / chair  
Struttura Laccato Platino opaco,  
seduta e schienale tessuto Smile 21 /  
Structure in Matt Platino lacquered,  
seat and back in Smile 21 fabric  
L45,5 P53 H78

The Aileron seat introduces a feature typically found on ergonomic office chairs into the home: a back rest that reclines gently to move naturally in sync with your back. The mechanism is simple and discreet.

La silla Aileron introduce en el ámbito doméstico una solución típica de los asientos ergonómicos de oficina: el respaldo móvil que, inclinándose con suavidad, se adapta de forma natural al movimiento de la espalda apoyada contra él. El mecanismo es muy sencillo y presenta un estilo minimalista.

La chaise Aileron introduit dans le monde domestique, une solution typique des sièges ergonomiques de bureau, à savoir un mouvement du dossier qui, en s'inclinant doucement, seconde naturellement le mouvement du dos en appui. Le mécanisme, très simple et minimal.

Der Stuhl Aileron vereint edles Wohndesign mit der Ergonomie von Bürosthühlen: mit einer Rückenlehne, die der Bewegung des Rückens dank eines einfachen und minimalistischen Mechanismus mit einer leichten Neigung auf natürliche Weise folgt.

Стул Aileron предлагает для домашней обстановки решение, типичное для эргономичных офисных стульев, а именно - движущуюся спинку, которая, слегка отклоняясь, поддерживает естественным образом движение опирающейся спины. Механизм достаточно простой и минималистский.





**AILERON** sedia / chair  
Struttura Laccato Platino opaco, seduta e schienale tessuto Smile 21/  
Structure in Matt Platino lacquered, seat and back in Smile 21 fabric  
L45,5 P53 H78





# Aileron

design **Giulio Iacchetti**

## Materiali e finiture

Struttura:  
Legno e acciaio armonico  
Rivestimento:  
Tessuto

## Materials and finishes

Structure:  
Wood and harmonic steel  
Covering:  
Fabric

## Materiales y acabados

Estructura:  
Madera y acero armónico  
Revestimiento:  
Tejidos

## Matériaux et finitions

Structure:  
Bois et acier harmonique  
Revêtement:  
Tissus

## Materialien und Ausführungen

Korpus:  
Holz und harmonischer Stahl  
Bezug:  
Stoff

## Материалы и варианты отделки

Каркас:  
Древесина и гармоническая сталь  
Обивка:  
Ткань

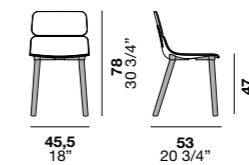



## CORIUM

design R.D.A.

Corium è una sedia dalla forma molto contenuta, disponibile con un rivestimento in cuoio e con uno schienale alto 93 cm o più contenuto, 80 cm.

Corium is a highly compact seat, available upholstered in leather and with a high (93 cm) or low (80 cm) back rest.

Corium es una silla de formas sumamente sencillas, disponible con un revestimiento de cuero y con un respaldo de 93 cm de altura o más reducido, de 80 cm.

Corium est une chaise à la forme très contenue, disponible avec un revêtement en cuir et un dossier de 93 cm de hauteur ou plus contenu de 80 cm.

Corium ist ein sehr kompakter Stuhl, erhältlich mit einem Lederbezug und einer Rückenlehne von 93 cm Höhe oder noch kompakteren 80 cm.

Corium - стул небольших размеров, предлагаемый с кожаной обивкой и спинкой высотой 93 см или еще меньше - 70 см.

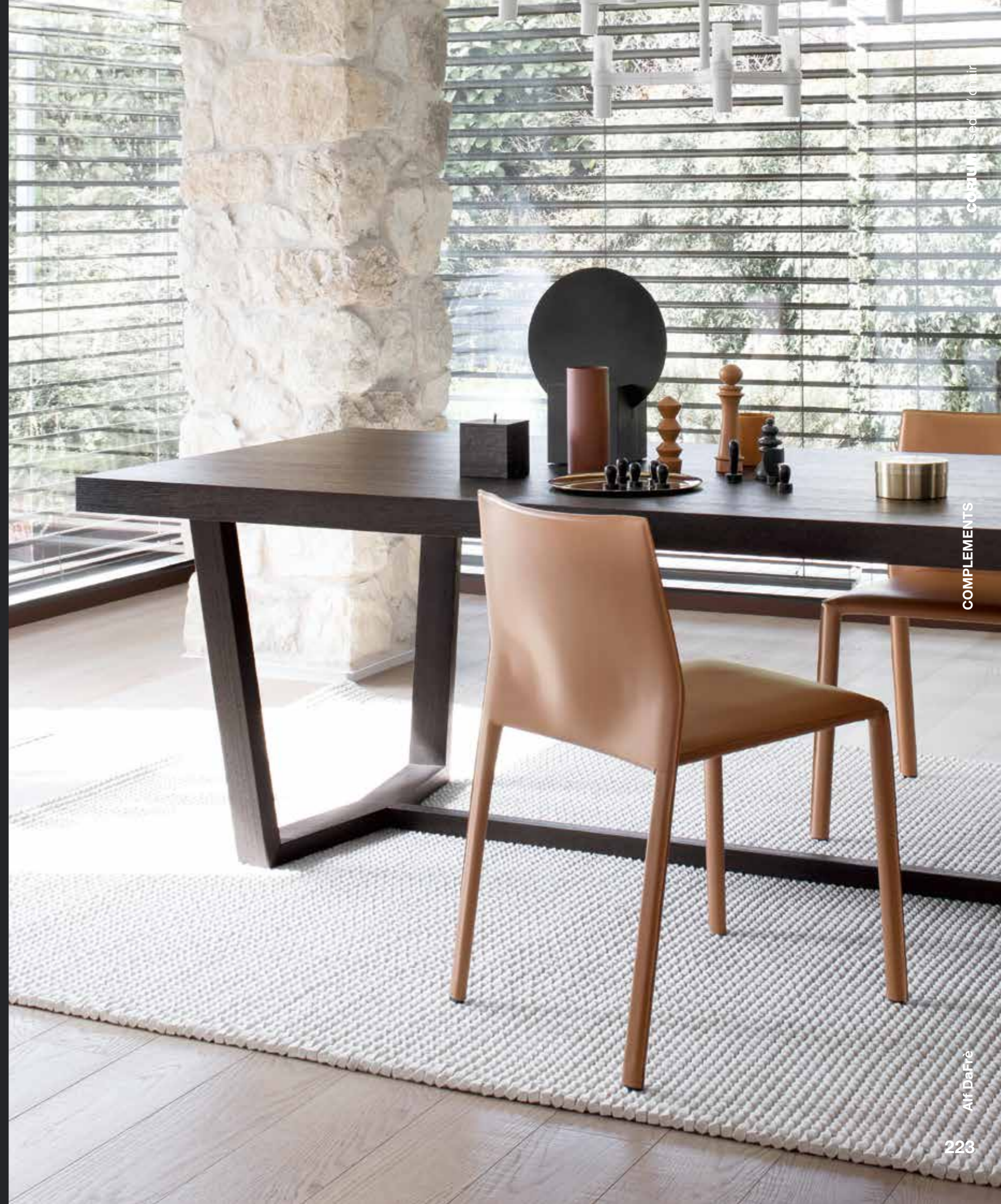



**CORIUM** sedia / chair  
Cuio naturale / Natural leather L50,5 P55 H80





**CORIUM** sedia / chair  
Cuio 1031 /  
1031 leather L50,5 P55 H80/93



## Corium

design R.D.A.

### Materiali e finiture

Rivestimento:  
Cuoio

-

### Materials and finishes

Covering:  
Leather

-

### Materiales y acabados

Revestimiento:  
Piel

-

### Matériaux et finitions

Revêtement :  
Cuir

-

### Materialien und Ausführungen

Bezug:  
Leder

-

Материалы и варианты отделки

Обивка:  
Кожа

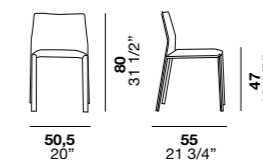
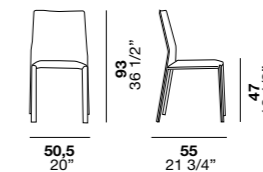

## ELEKTA

design R.D.A.

**Elekta è una sedia con struttura in legno, seduta e schienale imbottiti. La particolare conformazione dello schienale crea, di lato, un piacevole collegamento alla struttura e tramite uno scanso ne permette agevolmente lo spostamento.**

**CLIFF** tavolo / table  
Struttura e piano Fashion wood  
Rovere Terra /Structure and top  
in Terra oak Fashion wood  
L145 P145 H75,4  
**ELEKTA** sedia / chair  
Struttura Fashion wood Rovere  
Terra, seduta e schienale in  
tessuto Smile 13 /Structure in  
Terra oak Fashion wood, seat  
and back in Smile 13 fabric  
L46,3 P52 H80,4

The Elekta chair has a wooden structure and padded seat and back. The special shape of the seat back creates a pleasant connection with the structure on one side, and makes it easy to move thanks to a recess.

Elekta es una silla con estructura de madera y asiento y respaldo tapizados. La particular conformación del respaldo crea, de lado, un agradable efecto de unión con la estructura y, gracias a un entrante, puede desplazarse con comodidad.

Elekta est une chaise avec structure en bois, assise et dossier rembourrés. La conformation particulière du dossier crée, sur le côté, une agréable liaison avec la structure et moyennant une échancrure facilite son déplacement.

Elektra ist ein Stuhl mit Holzkorpus mit gepolsterter Sitzfläche und Rückenlehne. Die besondere Form der Rückenlehne schafft auf der Seite eine schöne Verbindung zum Korpus. Dank der Aussparung kann der Stuhl bequem bewegt werden.

Elekta - стул с деревянным каркасом, мягким сиденьем и спинкой. Особый вариант спинки создает, с одной стороны, приятное соединение с каркасом и посредством специального паза обеспечивает возможность удобного перемещения.





## Elekta

design R.D.A.

### Materiali e finiture

Struttura:  
Fashion wood / Rovere colori opachi  
Seduta e schienale imbottiti:  
Tessuto / Pelle / Ecopelle

### Materials and finishes

Structure:  
Fashion wood / Oak matt colours  
Padded seat and seat back:  
Fabric / Leather / Ecoleather

### Materiales y acabados

Estructura:  
Fashion wood / Roble teñido colores mate  
Asiento y respaldo tapizados:  
Tejido / Piel / Eco-piel

### Matériaux et finitions

Structure :  
Fashion wood / Chêne laqué mat  
Assise et dossier rembourrés :  
Tissu / Cuir / Éco-cuir

### Materialien und Ausführungen

Korpus:  
Fashion Wood / Eiche matte Farben  
Gepolsterte Sitzfläche und Rückenlehne:  
Stoff / Leder / Kunstleder

### Материалы и варианты отделки

Каркас:  
Fashion wood / Дуб матовых цветов  
Мягкое сиденье и спинка:  
Ткань / Кожа / Экокожа

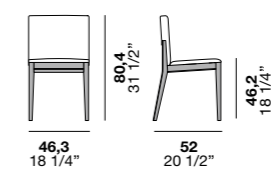

## ESEDRA

design R.D.A.

**Esedra è una sedia con struttura in legno massello, seduta e schienale imbottiti. La forma regolare della struttura supporta dei pannelli imbottiti particolarmente sottili ma confortevoli.**

The Esedra chair has a solid wood structure and padded seat and back. The regular shape of the structure supports the padded panels which are especially slender yet ultimately comfortable.

Esedra es una silla con estructura de madera maciza y asiento y respaldo tapizados. La forma regular de su estructura sostiene unos paneles tapizados de muy poco grosor pero cómodos.

Esedra est une chaise avec structure en bois massif, assise et dossier rembourrés. La forme régulière de la structure supporte des panneaux rembourrés particulièrement fins mais confortables.

Esedra ist ein Stuhl mit einem Korpus aus massivem Holz und einer gepolsterten Sitzfläche und Rückenlehne. Die gerade Form des Korpus trägt die gepolsterte schlanke, aber bequeme Sitzfläche.

Esedra - стул с каркасом из массива дерева, мягким сиденьем и спинкой. На каркас правильной формы опираются мягкие тонкие, но в то же время удобные панели.





**ALIANTE** tavolo / table  
 Laccato Bianco opaco, calzini Fashion wood Rovere Canapa /  
 Matt Bianco lacquered, feet in Canapa oak Fashion wood L200 P90 H73,5  
**ESEDRA** sedia / chair  
 Struttura Fashion wood Rovere Canapa, seduta e schienale tessuto Smile 2 /  
 Structure in Canapa oak Fashion wood, seat and back in Smile 2 fabric L50 P56 H84







## Esedra

design R.D.A.

### Materiali e finiture

Struttura:  
Fashion wood / Rovere colori opachi  
Seduta e schienale imbottiti:  
Tessuto / Pelle / Ecopelle

### Materials and finishes

Structure:  
Fashion wood / Oak matt colours  
Padded seat and seat back:  
Fabric / Leather / Ecoleather

### Materiales y acabados

Estructura:  
Fashion wood / Roble teñido colores mate  
Asiento y respaldo tapizados:  
Tejido / Piel / Eco-piel

### Matériaux et finitions

Structure :  
Fashion wood / Chêne laqué mat  
Assise et dossier rembourrés :  
Tissu / Cuir / Éco-cuir

### Materialien und Ausführungen

Korpus:  
Fashion Wood / Eiche matte Farben  
Gepolsterte Sitzfläche und Rückenlehne:  
Stoff / Leder / Kunstleder

### Материалы и варианты отделки

Каркас:  
Fashion wood / Дуб матовых цветов  
Мягкое сиденье и спинка:  
Ткань / Кожа / Экокожа

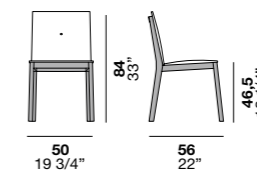

## KARINA

design R.D.A.

Karina è una sedia con struttura in legno disponibile nella variante con seduta imbottita. Karina può inoltre essere “celata” con una veste in tessuto creata sulle sue forme.

The Karina chair has a wooden structure and it is available in the version with padded seat. Karina can also be “concealed” by a fabric floor-length cover created with the exact same shape.

Karina es una silla con estructura de madera, disponible en la variante con asiento tapizado. Además, Karina puede “ocultarse” bajo un revestimiento de tejido creado con sus formas.

Karina est une chaise avec structure en bois disponible avec assise rembourrée. Karina peut également être “renfermée” dans un revêtement en tissu créé sur ses formes.

Karina ist ein Stuhl mit Holzkorpus und auch in der Variante mit gepolsterter Sitzfläche erhältlich. Karina kann auch mit einer Husse bezogen werden, die passgenau für die Formen des Stuhls entworfen wurde.

Karina - стул с деревянным каркасом, предусмотрен в варианте с мягким сиденьем. Karina также может быть “одет” в ткань в соответствии с его формами.





**ALIANTE** tavolo / table  
 Laccato Anfora opaco, calzini Fashion wood Rovere Canapa /  
 Matt Anfora lacquered, feet in Canapa oak Fashion wood L200 P90 H73,5  
**KARINA** sedia / chair  
 Struttura Fashion wood Rovere Canapa, seduta e schienale tessuto Ranger 33 /  
 Structure in Canapa oak Fashion wood, seat and back in Ranger 33 fabric L45,5 P53 H81



# Karina

design R.D.A.

## Materiali e finiture

Struttura:  
Fashion wood / Rovere colori opachi / Colori opachi  
Cuscino imbottito:  
Tessuti / Pelle / Ecopelle

## Materials and finishes

Structure:  
Fashion wood / Oak matt colours / Matt colours  
Padded cushion:  
Fabric / Leather / Ecoleather

## Materiales y acabados

Estructura:  
Fashion wood / Roble teñido colores mate / Colores mate  
Cojín tapizado:  
Tejidos / Piel / Eco-piel

## Matériaux et finitions

Structure :  
Fashion wood / Chêne laqué mat / Laqués mats  
Coussin rembourré :  
Tissus / Cuir / Éco-cuir

## Materialien und Ausführungen

Korpus:  
Fashion Wood / Eiche matte Farben / Matte Farben  
Polsterkissen:  
Stoff / Leder / Kunstleder

## Материалы и варианты отделки

Каркас:  
Fashion wood / Дуб матовых цветов / Матовые цвета  
Мягкая подушка:  
Ткань / Кожа / Экокожа

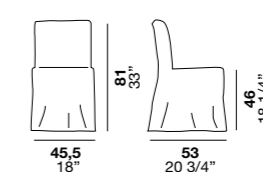
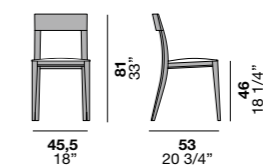
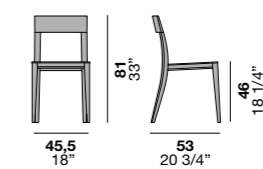

## KAROL / KAROL WOOD

design R.D.A.

Karol e Karol wood sono sedie imbottite e sfoderabili nelle versioni in tessuto. Karol wood abbina gambe in legno ai rivestimenti di seduta e schienale.

Karol and Karol wood are padded chairs with removable covers in the fabric version. Karol wood combines wooden legs with upholstered seat and back.

Karol y Karol wood son sillas tapizadas y desenfundables en las versiones en tejido. Karol wood combina patas de madera con los revestimientos de asiento y respaldo.

Karol et Karol wood sont des chaises rembourrées et déhoussables dans les versions en tissu. Karol wood associe des pieds en bois aux revêtements d'assise et de dossier.

Karol und Karol Wood sind Polsterstühle mit abnehmbarem Bezug in der Version mit Stoffbezug. Karol Wood kombiniert Beinen aus Holz mit bezogenen Sitzflächen und Rückenlehnen.

Karol и Karol wood - мягкие со снимаемой обивкой стулья в тканевых вариантах. Karol wood характеризуется сочетанием деревянных ножек с обивкой сиденья и спинки.





**KAROL** sedia / chair  
Tessuto St. Moritz 162 /  
St. Moritz 162 fabric L50 P62 H80



**BOARD** tavolo / table  
 Struttura verniciato Ghisa, piano Rovere antico Biscotto /  
 Structure in Ghisa painted, top in Antique walnut Biscotto L240 P100 H75  
**KAROL WOOD** sedia / chair  
 Ecopelle Alce 240 , gambe Fashion wood Rovere Biscotto /  
 Alce 240 ecoleather, legs in Biscotto oak Fashion wood L50 P62 H80  
**RECTA** credenza / sideboard  
 Laccato Ghisa opaco, Rovere antico Biscotto /  
 Matt Ghisa lacquered, Antique walnut Biscotto Fashion wood L246,8 P55 H78,2



# Karol / Karol Wood

design R.D.A.

## Materiali e finiture

Rivestimento:  
Tessuto / Pelle / Ecopelle  
Gambe (Karol wood):  
Fashion wood / Rovere colori opachi / Colori opachi / Fassino tinto noce

## Materials and finishes

Covering:  
Fabric / Leather / Ecoleather  
Legs (Karol wood):  
Fashion wood / Oak matt colours / Matt colours / Walnut tinted ash

## Materiales y acabados

Revestimiento:  
Tejido / Piel / Eco-piel  
Patas (Karol wood):  
Fashion wood / Roble teñido colores mate / Colores mate / Fresno teñida nogal

## Matériaux et finitions

Revêtement :  
Tissu / Cuir / Éco-cuir  
Pieds (Karol wood) :  
Fashion wood / Chêne laqué mat / Laqués mats / Frêne teinte noyer

## Materialien und Ausführungen

Bezug:  
Stoff / Leder / Kunstleder  
Beinen (Karol Wood):  
Fashion Wood / Eiche matte Farben / Matte Farben / Esche Farbe Nussbaum

## Материалы и варианты отделки

Обивка:  
Ткань / Кожа / Экокожа  
Ножи (Karol wood):  
Fashion wood / Дуб матовых цветов / Матовые цвета / ясеня цвета орех

## Karol

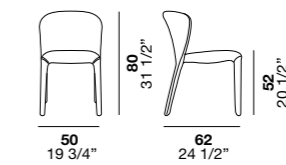

## Karol Wood

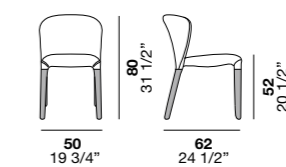

Colori opachi  
Matt colours  
Colores mate  
Laqués mats  
Matte Farben  
Матовые цвета



Rovere colori opachi  
Oak matt colours  
Roble teñido colores mate  
Chêne laqué mat  
Eiche matte Farben  
Дуб матовых цветов



Fashion wood  
Fashion wood  
Fashion wood  
Fashion wood  
Fashion wood



Frassino tinto noce  
Walnut tinted ash  
Fresno teñida nogal  
Frêne teinte noyer  
Esche Farbe Nussbaum  
Ясеня цвета орех



## VIKY

design Bruna Vaccher

**Viky è una sedia con struttura in legno massello di rovere in cui lo schienale prosegue sui lati dando forma ai braccioli.**

**Viky è disponibile in due varianti: seduta e schienale verticale imbottiti (Viky 2), seduta e schienale orizzontale imbottiti (Viky 3).**

The Viky chair has a solid oak wood structure, where the armrests are a continuation of the seat back. Viky is available in two versions: with a padded seat and vertical seat back (Viky 2), and with a padded seat and horizontal seat back (Viky 3).

Viky es un silla con estructura de madera maciza de roble, en la que el respaldo continúa por los lados para dar forma a los reposa-brazos. Viky está disponible en dos variantes: asiento y respaldo vertical tapizados (Viky 2), asiento y respaldo horizontal tapizados (Viky 3).

Viky est une chaise avec structure en chêne massif sur laquelle le dossier continue sur les côtés en donnant forme aux accoudoirs. Viky est disponible en deux variantes : assise et dossier vertical rembourrés (Viky 2), assise et dossier horizontal rembourrés (Viky 3).

Viky ist ein Stuhl mit einem Korpus aus massivem Eichenholz, bei dem die Rückenlehne sich bis auf die Seiten verlängert und so die Armlehnen formt. Viky ist in zwei Varianten erhältlich: mit gepolsterter Sitzfläche und vertikaler Polsterlehne (Viky 2), mit gepolsterter Sitzfläche und horizontaler Polsterlehne (Viky 3).

Viky - стул с каркасом из массива дуба, спинка которого продолжается с боковых сторон, придавая форму подлокотникам. Viky предлагается в двух вариантах: обитые сиденье и вертикальная спинка (Viky 2), обитые сиденье и горизонтальная спинка (Viky 3).



COMPLEMENTS

Alf DaFrè



**JAG** tavolo / table  
 Struttura verniciato nero trasparente lucido, piano Fashion wood Rovere Biscotto /  
 Structure in Gloss black transparent painted, top Biscotto oak Fashion wood L140 P140,4 H75  
**VIKY** sedia / chair  
 Struttura Fashion wood Rovere Biscotto, seduta e schienale tessuto Mistral plain 11 /  
 Structure in Biscotto oak Fashion wood, seat and back in Mistral plain 11 fabric L59 P52 H76,5  
**DOMINO** elementi / elements  
 Laccato Ghisa opaco /  
 Matt Ghisa lacquered L384 P34,4 H32  
**DOMINO** elementi / elements  
 Laccato Ghisa opaco /  
 Matt Ghisa lacquered L96 P34,4 H272



# Viky

design **Bruna Vaccher**

## Materiali e finiture

Struttura:  
Fashion wood / Rovere colori opachi  
Seduta e schienale imbottiti:  
Tessuti / Pelle / Ecopelle

## Materials and finishes

Structure:  
Fashion wood / Oak matt colours  
Padded seat and seat back:  
Fabric / Leather / Ecoleather

## Materiales y acabados

Estructura:  
Fashion wood / Roble teñido colores mate  
Asiento y respaldo tapizados:  
Tejidos / Piel / Eco-piel

## Matériaux et finitions

Structure :  
Fashion wood / Chêne laqué mat  
Assise et dossier rembourrés :  
Tissus / Cuir / Éco-cuir

## Materialien und Ausführungen

Korpus:  
Fashion Wood / Eiche matte Farben  
Gepolsterte Sitzfläche und Rückenlehne:  
Stoff / Leder / Kunstleder

## Материалы и варианты отделки

Каркас:  
Fashion wood / Дуб матовых цветов  
Мягкое сиденье и спинка:  
Ткань / Кожа / Экокожа

Viky 2

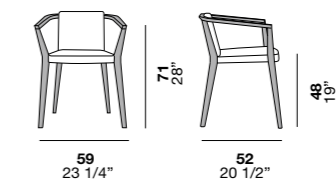

Viky 3

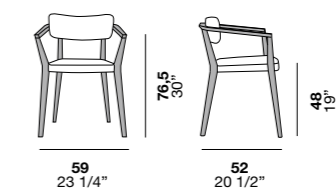

## accessori librerie

accessories  
bookcases

---



**Domino**  
pag. 262



**Free, Pod**  
pag. 268



**Press**  
pag. 274



**Up**  
pag. 278



**Versus**  
pag. 282



**Haiku / Haiku Servomuto**  
pag. 286

## DOMINO

design R.D.A.

Domino è un sistema di contenitori pensili con vani a giorno, ante e cassetti.  
Disponibili in molte configurazioni posizionabili orizzontalmente o verticalmente crea piacevoli contrasti abbinando differenti finiture tra struttura e frontali.

Domino elementi / elements  
Laccato Ghisa opaco /  
Matt Ghisa lacquered  
L384 P34,4 H32 / L96 P34,4 H272

Domino is a range of wall-mounted storage units with open compartments, doors and drawers.  
It is available in a host of different configurations, which can be positioned either horizontally or vertically, to create mesmerizing contrasts by matching different finishes in the structure and fronts.

Domino es un sistema de contenedores colgantes con compartimentos abiertos, puertas y cajones.  
Están disponibles en multitud de configuraciones que se pueden orientar en horizontal o vertical, creando bellos contrastes mediante la combinación de acabados distintos entre la estructura y los frontales.

Domino est un système de modules suspendus avec niches ouvertes portes et tiroirs.  
Disponibles en différentes configurations positionnables horizontalement ou verticalement, il crée d'agréables contrastes en associant différentes finitions entre structure et façades.

Domino ist ein Hängeelemente-System mit Offenfächern, Türen und Schubladen.  
Es ist in zahlreichen Varianten erhältlich und kann sowohl horizontal als auch vertikal ausgerichtet werden. Dank der Möglichkeit, Korpus und Fronten in unterschiedlichen Ausführungen miteinander zu kombinieren, können lebhaftere Kontraste geschaffen werden.

Domino - система навесных контейнеров с открытыми отсеками, створками и ящиками.  
Предусмотрены в многочисленных конфигурациях, позиционируемых горизонтально или вертикально, создает приятные контрасты сочетания различных вариантов отделки каркаса и фронтальных панелей.







# Domino

design R.D.A.

## Materiali e finiture

Struttura: Fashion wood / Rovere colori opachi / Colori opachi  
Frontali: Fashion wood / Rovere colori opachi / Colori opachi

## Materials and finishes

Structure: Fashion wood / Oak matt colours / Matt colours  
Fronts: Fashion wood / Oak matt colours / Matt colours

## Materiales y acabados

Estructura: Fashion wood / Roble teñido colores mate / Colores mate  
Frontales: Fashion wood / Roble teñido colores mate / Colores mate

## Matériaux et finitions

Structure : Fashion wood / Chêne laqué mat / Laqués mats  
Façades : Fashion wood / Chêne laqué mat / Laqués mats

## Materialien und Ausführungen

Korpus: Fashion Wood / Eiche matte Farben / Matte Farben  
Fronten: Fashion Wood / Eiche matte Farben / Matte Farben

## Материалы и варианты отделки

Каркас: Fashion wood / Дуб матовых цветов / Матовые цвета  
Фронтальные панели: Fashion wood / Дуб матовых цветов / Матовые цвета

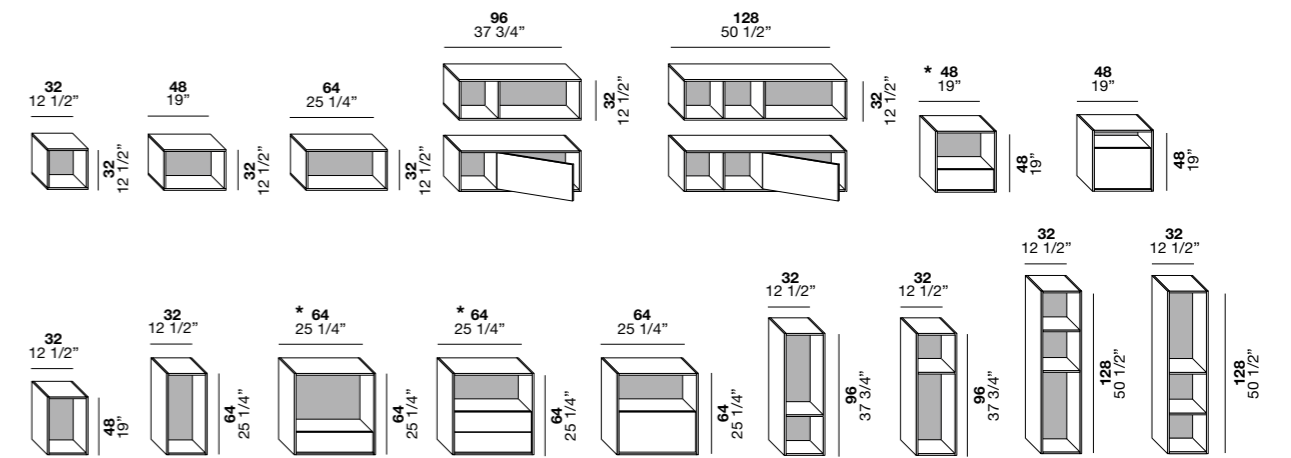

Prof. 28,3 11 1/4" - 34,4 13 1/2"

\* Non disponibili nella profondità 28,3 / Not available in the 28.3 depth / No disponibles en la profundidad 28,3 / Non disponibles avec la profondeur 28,3 / Nicht erhältlich mit der Tiefe 28,3 cm / Не предусмотрены глубиной 28,3

## FREE / POD

design R.D.A.

**Free è un sistema di schienali con mensoline da appendere a parete.**

**Pod è un contenitore in lamiera studiato per essere un perfetto complemento a questo sistema.**

**Le sue molteplici configurazioni e la possibilità di abbinare differenti finiture tra schienali e mensoline permettono di creare infinite composizioni.**

Free is a wall panelling systems with shelves for wall-mounting. Pod is a sheet storage unit devised to be the perfect partner for this system.

Its multiple configurations and the ability to combine various finishes for the back panels and shelves make it possible to create endless compositions.

Free es un sistema de paneles con pequeños estantes para colgar de la pared. Pod es un contenedor en chapa estudiado como complemento ideal para este sistema.

Sus múltiples configuraciones y la posibilidad de combinar acabados distintos entre los paneles de pared y los estantes permiten crear infinitas composiciones.

Free est un système de dossiers avec de petites étagères à accrocher au mur. Pod est un module en tôle conçu pour être un complément parfait de ce système.

Ses multiples configurations ainsi que la possibilité d'associer différentes finitions entre dossiers et petites étagères permettent de créer d'infinies compositions.

Free ist ein Rückwand-System mit Wandborden. Pod ist ein Anbauelement aus Blech, das eine ideale Ergänzung für dieses System ist. Die zahlreichen erhältlichen Varianten und die Möglichkeit unterschiedliche Ausführungen für Rückwände und Borde zu wählen, sorgen für unzählige Zusammenstellungen.

Free - система настенных задних панелей с полками. Pod - контейнер из листового металла, специально разработанный для превосходного дополнения данной системы. Многочисленные конфигурации и возможность сочетания различных вариантов отделки между задними стенками и полками позволяют создавать бесчисленное количество композиций.









## Free / Pod

design R.D.A.

### Materiali e finiture

#### Free

Schienale:  
Fashion wood / Rovere colori opachi / Colori opachi  
Mensole:  
Fashion wood / Rovere colori opachi / Colori opachi

#### Pod

Struttura:  
Colori opachi

### Materials and finishes

#### Free

Back panel:  
Fashion wood / Oak matt colours / Matt colours  
Shelves:  
Fashion wood / Oak matt colours / Matt colours

#### Pod

Structure:  
Matt colours

### Materiales y acabados

#### Free

Panel de pared:  
Fashion wood / Roble teñido colores mate / Colores mate  
Estantes:  
Fashion wood / Roble teñido colores mate / Colores mate

#### Pod

Estructura:  
Colores mate

### Matériaux et finitions

#### Free

Panneau mural :  
Fashion wood / Chêne laqué mat / Laqués mats  
Étagères :  
Fashion wood / Chêne laqué mat / Laqués mats

#### Pod

Structure :  
Laqués mats

### Materialien und Ausführungen

#### Free

Rückenlehne:  
Fashion Wood / Eiche matte Farben / Matte Farben  
Wandborde:  
Fashion Wood / Eiche matte Farben / Matte Farben

#### Pod

Korpus:  
Matte Farben

### Материалы и варианты отделки

#### Free

Задняя стенка:  
Fashion wood / Дуб матовых цветов / Матовые цвета

Полки:  
Fashion wood / Дуб матовых цветов / Матовые цвета

#### Pod

Каркас:  
Матовые цвета

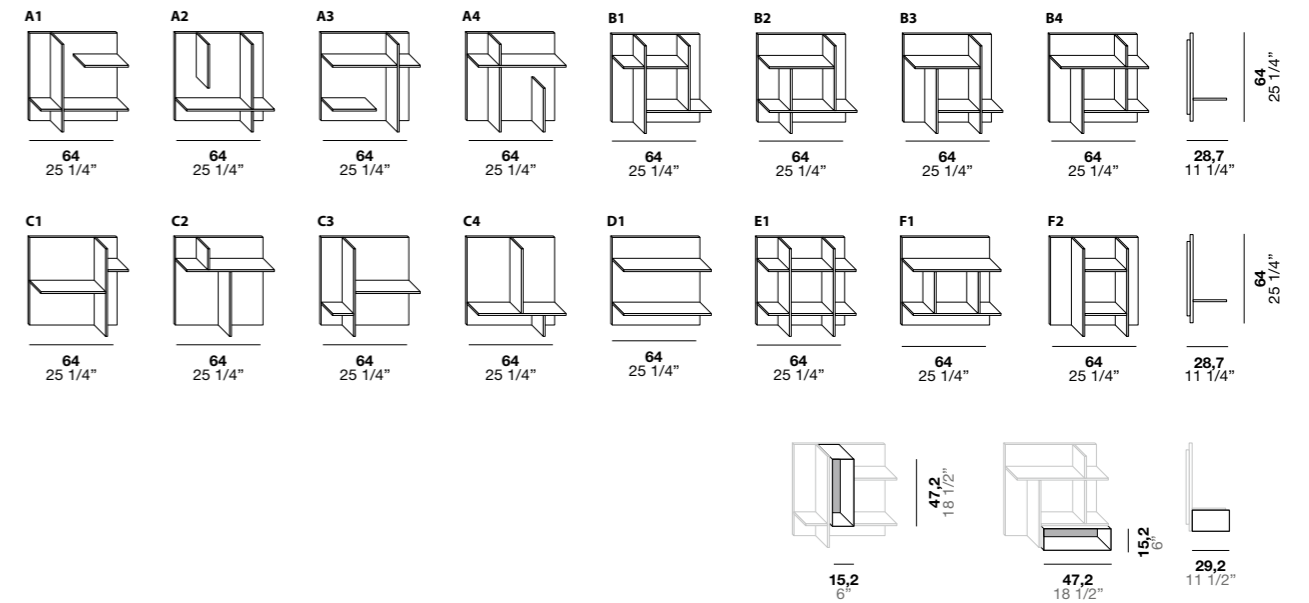

## PRESS

design R.D.A.

Press è un porta libri da parete in metallo verniciato con mensoline riposizionabili.

Press is a wall-mounted bookcase in painted metal with movable shelves.

Press es un porta libros mural de metal barnizado con estantes pequeños recolocables.

Press est un porte-livres mural en métal verni avec de petites étagères positionnables.

Press ist ein Wandbücherregal aus lackiertem Metall mit versetzbaren Borden.

Press - настенная книжная полка из крашеного металла с передвижными полками.





## Press

design R.D.A.

### Materiali e finiture

Struttura:  
Bianco opaco / Nero opaco

### Materials and finishes

Structure:  
Matt bianco / Matt nero

### Materiales y acabados

Estructura:  
Bianco mate / Nero mate

### Matériaux et finitions

Structure :  
Bianco mat / Nero mat

### Materialien und Ausführungen

Korpus:  
Bianco matt / Nero matt

### Материалы и варианты отделки

Каркас:  
Bianco матовый / Nero матовый

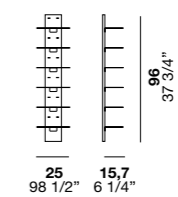

**UP**

design Haften Studio

**Up è una libreria con struttura in metallo verniciato e mensole in varie essenze o laccati. Up è disponibile in tre configurazioni.**

**Up** libreria /bookcase  
Laccato opaco bianco /  
Matt Bianco lacquered  
L79,8 P33,2 H99,8

The Up bookcase has a painted metal structure and shelves which are available in various wood finishes or lacquer colours. Up is available in three configurations.

Up es una librería con estructura de metal barnizado y estantes de diversas maderas o lacados. Up está disponible en tres configuraciones.

Up est une bibliothèque avec structure en métal verni et des étagères en différents bois ou laquées. Up est disponible en trois configurations.

Up ist ein Regal mit einem Korpus aus lackiertem Metall und Borden, die in unterschiedlichen Holzarten oder verschiedenen Lackierungen erhältlich sind. Up ist in drei Varianten erhältlich.

Up - книжный шкаф с каркасом из крашеного металла и полками из различного дерева или в крашеной отделке. Up предусмотрен в трех конфигурациях.





# Up

design **Haften Studio**

## Materiali e finiture

Struttura:  
Verniciato bianco / Verniciato moka shine / Verniciato nero trasparente lucido  
Mensole:  
Rovere termocotto / Fashion wood / Rovere colori opachi / Colori opachi / Nobilitato

## Materials and finishes

Structure:  
Bianco painted / Moka shine painted / High gloss transparent nero painted  
Shelves:  
Baked oak / Fashion wood / Oak matt colours / Matt colours / Surfaced

## Materiales y acabados

Estructura:  
Barnizado blanco / Barnizado moka shine / Barnizado nero trasparente brillante  
Estantes:  
Roble termotratado / Fashion wood / Roble teñido colores mate / Colores mate / Ennoblecido

## Matériaux et finitions

Structure :  
Verni bianco / Verni moka shine / Verni nero transparent brillant  
Étagères :  
Chêne thermo-traité / Fashion Wood / Chêne laqué mat / Laqués mats / Méla miné

## Materialien und Ausführungen:

Korpus:  
Lackiert Bianco / Lackiert moka shine / Lackiert Nero transparent glänzend  
Wandborde:  
Thermo-Eiche / Fashion Wood / Eiche matte Farben / Matte Farben / Melamin

## Материалы и варианты отделки

Каркас:  
Крашенный bianco / Крашенный moka shine / Крашенный nero прозрачный глянцевый  
Полки:  
Дуб термочотто / Fashion wood / Дуб матовых цветов / Матовые цвета / Ламинированный

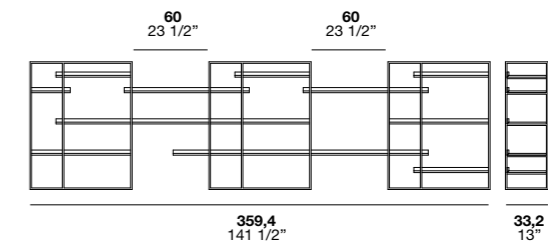
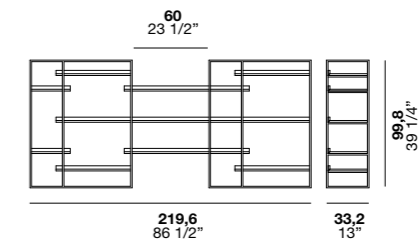
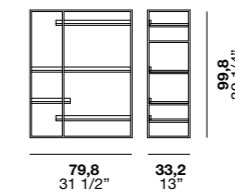

## VERSUS

design R.D.A.

**Versus è un sistema di contenitori pensili con vani a giorno.**

**La possibilità di abbinare differenti finiture tra struttura e interno e il posizionamento orizzontale o verticale danno ampia possibilità di utilizzo.**

**Versus** elementi /elements  
Laccato Juta opaco, Anfora opaco e Fashion wood  
Rovere Naturale /  
Matt Juta laquered, Matt Anfora and Fashion wood Natural oak  
L225,2 P28,3 H160

Versus is a range of wall-mounted storage units with open compartments. The possibility of combining different finishes for both the structure and the interior, along with the horizontal or vertical positioning option means this collection can be used in the most multifarious settings.

Versus es un sistema de contenedores colgantes con compartimentos abiertos. La posibilidad de combinar distintos acabados entre estructura e interior y la colocación en horizontal o vertical ofrecen amplias posibilidades de uso.

Versus est un système de modules suspendus avec niches ouvertes. La possibilité d'associer différentes finitions entre structure et intérieur et le positionnement horizontal ou vertical fournissent une ample possibilité d'utilisation.

Versus ist ein Hängeelemente-System mit Offenfächern. Die Möglichkeit, Korpus und Innenseiten in unterschiedlichen Ausführungen miteinander zu kombinieren und zwischen einer horizontalen und einer vertikalen Position zu wählen, machen aus Versus eine vielseitige Einrichtungslösung.

Versus - система навесных контейнеров с открытыми отсеками. Возможность сочетания различных вариантов отделки каркаса и внутренней отделки, а также горизонтальное или вертикальное позиционирование обеспечивают многочисленные возможности применения.





## Versus

design R.D.A.

### Materiali e finiture

Struttura:  
Fashion wood / Rovere colori opachi /  
Colori opachi / Colori lucidi  
Interno:  
Fashion wood / Rovere colori opachi /  
Colori opachi / Colori lucidi

### Materials and finishes

Structure:  
Fashion wood / Oak matt colours / Matt  
colours / High gloss colours  
Interior:  
Fashion wood / Oak matt colours / Matt  
colours / High gloss colours

### Materiales y acabados

Estructura:  
Fashion wood / Roble teñido colores  
mate / Colores mate / Colores brillantes  
Interior:  
Fashion wood / Roble teñido colores  
mate / Colores mate / Colores brillantes

### Matériaux et finitions

Structure :  
Fashion wood / Chêne laqué mat /  
Laqués mats / Laqués brillants  
Intérieur :  
Fashion wood / Chêne laqué mat /  
Laqués mats / Laqués brillants

### Materialien und Ausführungen

Korpus:  
Fashion Wood / Eiche matte Farben /  
Matte Farben / Glänzende Farben  
Innenseite:  
Fashion Wood / Eiche matte Farben /  
Matte Farben / Glänzende Farben

### Материалы и варианты отделки

Каркас:  
Fashion wood / Дуб матовых цветов /  
Матовые цвета / Глянцевые цвета  
Внутренняя отделка:  
Fashion wood / Дуб матовых цветов /  
Матовые цвета / Глянцевые цвета

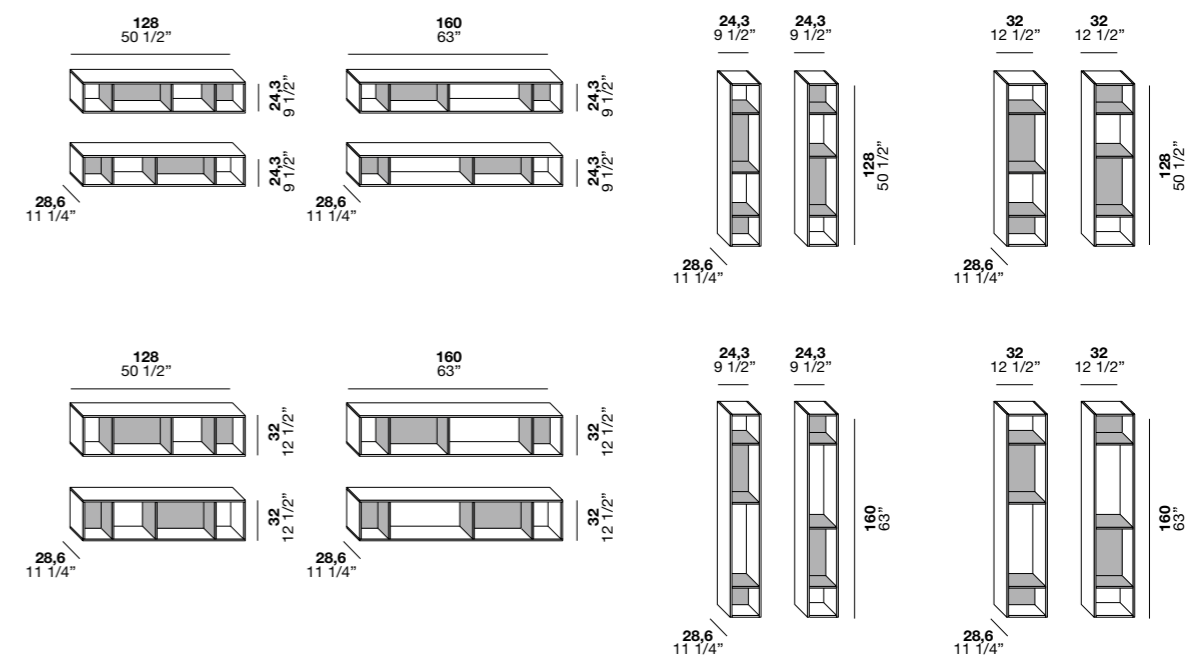



## HAIKU / HAIKU SERVOMUTO

design Bruna Vaccher

É un sistema semplice per riporre gli abiti velocemente, alloggiare gli accessori che ci accompagnano durante la giornata, mantenere in ordine la stanza da letto. Disponibile nella versione a muro con lo specchio inserito o come semplice oggetto da centro stanza.

Haiku servomuto / clothing  
Struttura Moka shine, mensole  
Fashion wood Rovere Biscotto /  
Structure Moka shine, shelves  
Biscotto oak Fashion wood  
L50 P32 H120,3

Haiku is a simple arrangement for quickly tidying clothes, storing your essential everyday accessories, and keeping your bedroom space clutter-free. Also available in a wall-mounted version with a mirror or as a simple centre piece for your bedroom.

Es un sistema sencillo para guardar rápidamente la ropa y los accesorios que nos acompañan durante el día, manteniendo el dormitorio ordenado. Disponible en versión de pared con el espejo integrado o como simple elemento de libre instalación.

C'est un système simple pour ranger les vêtements rapidement, loger les accessoires qui nous accompagnent pendant la journée, maintenir la chambre à coucher en ordre. Disponible dans la version murale avec le miroir inséré ou comme simple objet au centre de la pièce.

Ein einfaches System für die Aufbewahrung von Kleiderstücken und anderen Dingen, die uns den Tag über begleiten – so bleibt das Schlafzimmer immer aufgeräumt. Erhältlich in der Wandversion mit eingesetztem Spiegel oder in der einfachen Version zum Aufstellen im Raum.

Простая система для быстрого расположения одежды, аксессуаров, сопровождающих нас в течение дня, поддержания порядка спальни. Предусмотрена как в настенном варианте, так и с зеркалом, или просто как предмет, устанавливаемый по центру комнаты.



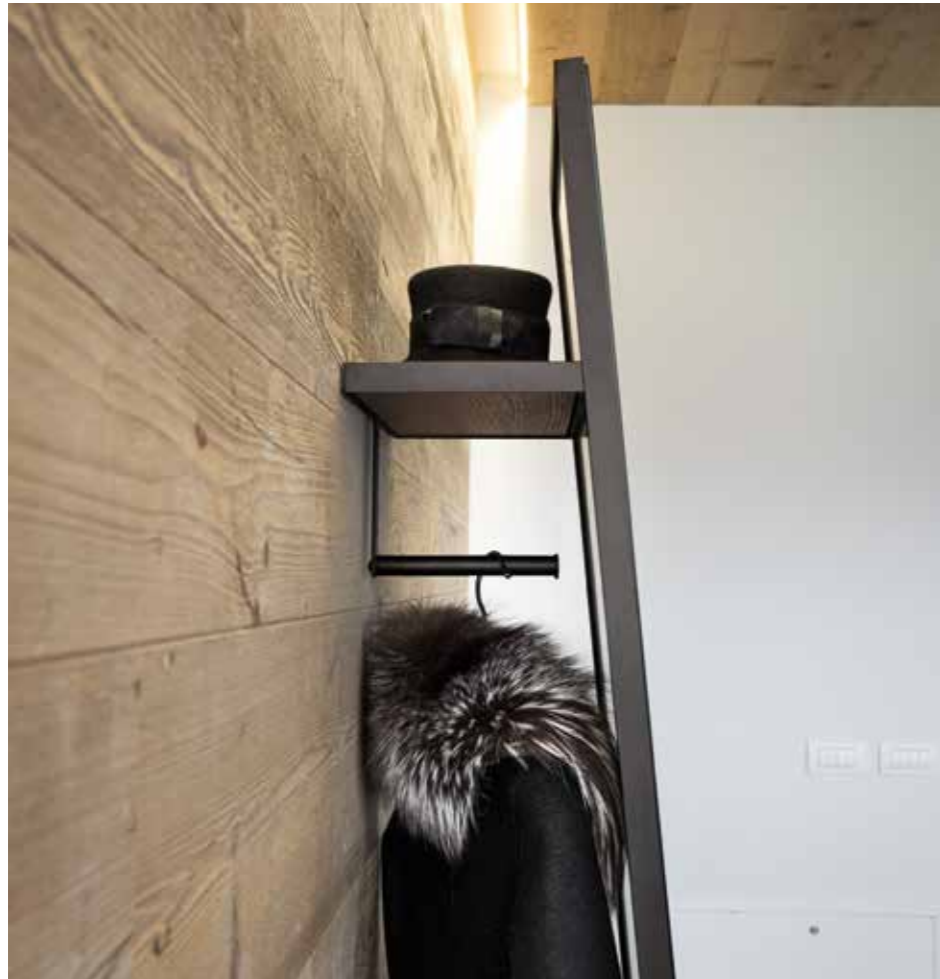

**HAIKU** specchiera / mirror  
 Struttura Moka shine, mensole Fashion wood Rovere Biscotto /  
 Structure Moka shine, shelves Biscotto oak Fashion wood L50 P39,7 H189,7

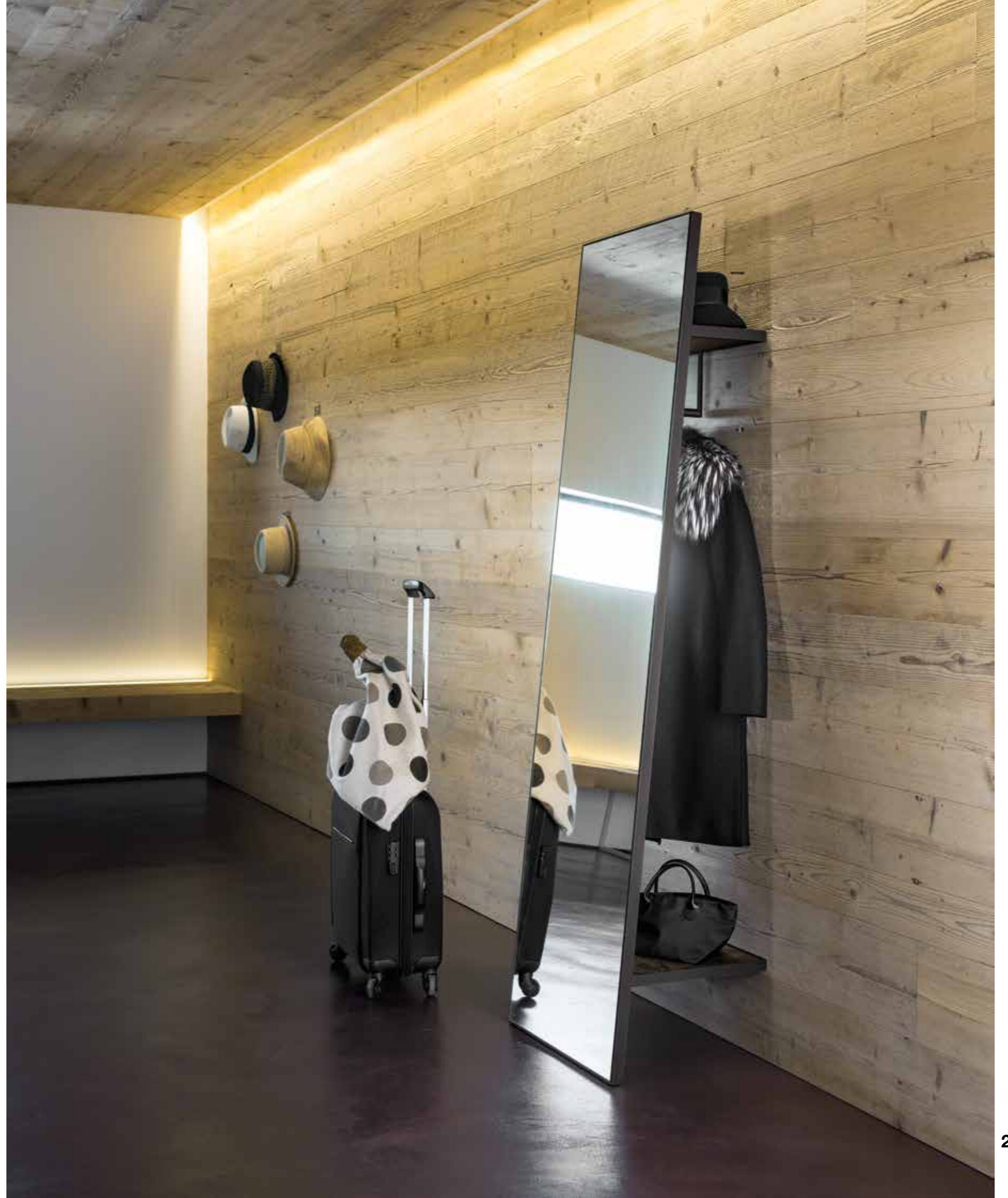



## Haiku / Haiku Servomuto

design **Bruna Vaccher**

### Materiali e finiture

Struttura:  
Verniciato Moka Shine  
Ripiani:  
Fashion wood / Rovere laccati opachi / Laccati opachi e lucidi / Nobilitati

### Materials and finishes

Frame:  
Painted Moka Shine  
Shelves:  
Fashion Wood / matt lacquered oak / matt and high-gloss lacquer/ surface finishes

### Materiales y acabados

Estructura:  
Barnizado Moka Shine  
Baldas:  
Fashion wood / Roble lacados mate / Lacados mate y brillantes / Ennoblecidos

### Matériaux et finitions

Structure :  
Verni Moka Shine  
Étagères :  
Fashion wood / Chêne laqué mat / Laqués mats et brillants / Mé laminés

### Materialien und Ausführungen

Korpus:  
Lackiert Moka Shine  
Fachböden:  
Fashion Wood / Eiche matt lackiert / matt und glänzend lackiert / Melamin

### Материалы и варианты отделки

Каркас:  
Крашенный Moka Shine  
Полки:  
Fashion wood / Дуб крашенный матовый / Крашенный матовый и глянцевый / Ламинированный

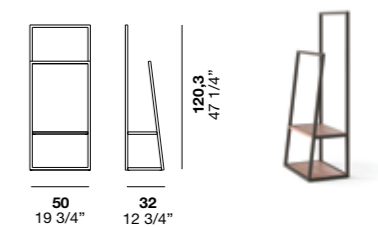
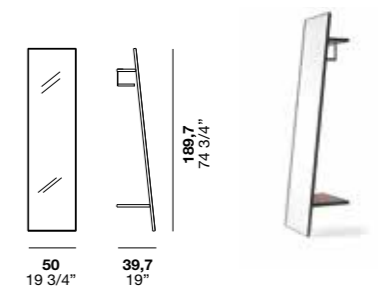

art direction  
**Bruna Vaccher**  
**Genny Canton**

concept/set coordinator/graphic  
**Genny Canton Studio**

photo  
**Contratti Company**  
**Beppe Brancato**

digital image  
**Nudesign**  
**Genny Canton Studio**

styling  
**Rosanna Bignucolo**  
**Claudia Barberi**

separations  
**Luce srl**

print  
**Sincromia** - cod.: 180758

ristampa 05/2018

thanks to:  
**Être Concept Store - Pordenone**  
**Abbigliamento Da Re 1906 - Sacile**



**ALF UNO Spa**  
Via S. Pio X 17  
31018 Francenigo di Gaiarine  
Treviso, Italy  
Tel. +39 0438 997111  
Fax Italia +39 0438 997245  
Fax estero +39 0438 997246  
www.alfdafre.it alf@alf.it

Verifica le finiture disponibili sul nostro sito internet. / Check the finishes available on our website. / Consulte los acabados disponibles en nuestro sitio web. / Vérifiez les finitions disponibles sur notre site internet. / Überprüfen Sie auf unserer Webseite, ob die gewünschte Ausführung erhältlich ist. / Познакомьтесь с вариантами отделки на нашем интернет-сайте www.alfdafre.it

**ALF UNO s.p.a.** si riserva di apportare in qualsiasi momento modifiche a prodotti, misure e materiali, che ritenesse utili per esigenze di carattere produttivo e commerciale. Per essere sempre aggiornati vi invitiamo a consultare il nostro sito internet **www.alfdafre.it**.

#### **LE FINITURE**

I materiali utilizzati dalla nostra azienda sono selezionati tra i più affidabili per applicazione e resa estetica. Nonostante questo devono considerarsi tollerabili alcune differenze dovute alle caratteristiche stesse di materiali come essenze naturali, vetri, laccature e all'artigianalità di alcune fasi del processo produttivo che da sempre è un nostro valore aggiunto. Inoltre alcune finiture possono subire nel tempo maturazioni dovute all'azione della luce e del tempo. È importante quindi specificare se nell'ordine vi sono sostituzioni o completamenti per valutare insieme il miglior modo di procedere. Le tonalità di colore e le finiture illustrate vanno considerate puramente indicative. Verificare sempre la fattibilità dell'abbinamento finiture consultando l'interno del listino.

**ALF UNO s.p.a.** reserves the right to make any changes to products, measurements and materials at any time deemed useful for manufacturing and sales purposes. To stay up to date at all times, please visit our website **www.alfdafre.it**

#### **FINISHES**

The materials we use are selected among the most reliable products in terms of application and aesthetic rendering. Despite this, certain differences due to the very characteristics of materials such as natural wood finishes, glass and lacquers must be considered tolerable, as well as the hand-crafted nature of certain phases of the production process, which has always been one of our added values. In addition, some finishes may change over time, due to the effects of light and time. It is therefore important to specify whether there are replacements or completions in the order to assess the best way to proceed together. The finishes featured in this sample collection are purely indicative and are not available for all products. Please check in the price list if the finish is available for the chosen item. Orders will not be accepted for products with finishes not included in the price list. The colour shades and finishes illustrated herein are to be considered purely indicative. Always check the feasibility of finish combinations by consulting the price list contents.