



NEWS

MILAN
ILUMINACIÓN

ÍNDICE / INDEX



05



05

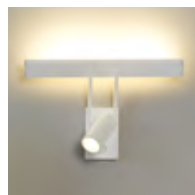

06

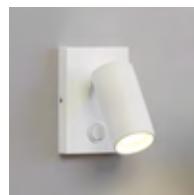

07



08



08



09



10



10

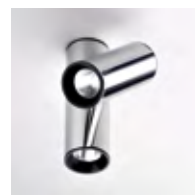

11



11

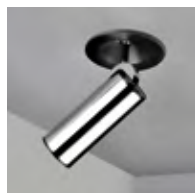

12



12



14



15

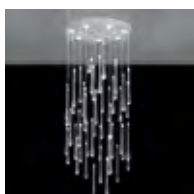

17



19



19

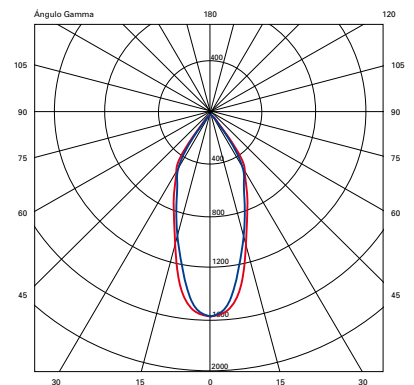
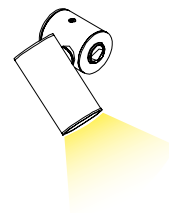
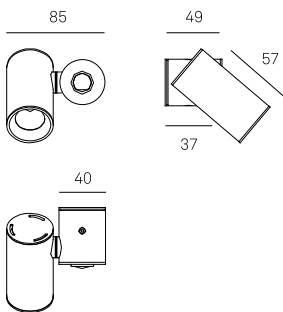

MLN Tub Led / 6510
Stefan Kährs

AI | NE
 Ø 85 | H 40 | S 87
 1 x LED PCB AC | 4 W | 300 lumens (x1)
 3.000K | \triangle 35° | Ra 80
 | | | EEL: **A+**

MLN Tub Led / 6511
Stefan Kährs

BL
 Ø 85 | H 40 | S 87
 1 x LED PCB AC | 4 W | 300 lumens (x1)
 3.000K | \triangle 35° | Ra 80
 | | | EEL: **A+**





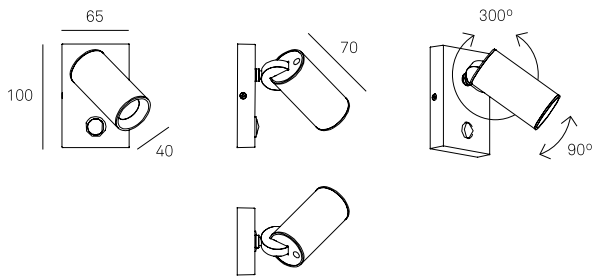

MLN Tub Led / 6512

Stefan Kährs

BL

Ø 65 | H 100 | S 70

1 x LED PCB AC | 4 W | 300 lumens (x1)

3.000K | \triangle 35° | Ra 80

| Dim. | INT. | EEL: A+

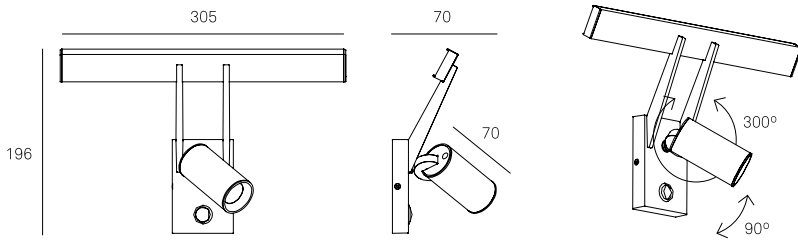
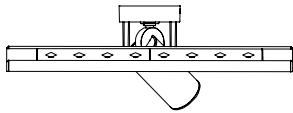

MLN Tub Led / 6513

Stefan Kährs

BL

Ø 305 | H 196 | S 120

1 x LED PCB AC | 4 W | 300 lumens (x1)

3.000K | \triangle 35° | Ra 80

2 x LED D.O.B. | 4,4 W | 400 lumens (x2)

3.000K | \triangle 35° | Ra 80

| Dim. | INT. | EEL: A+

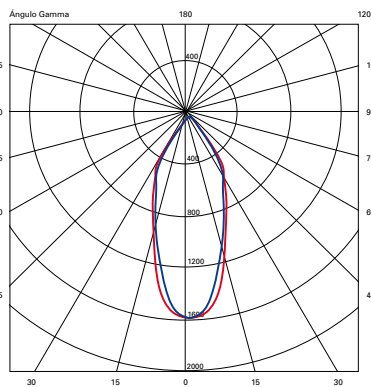
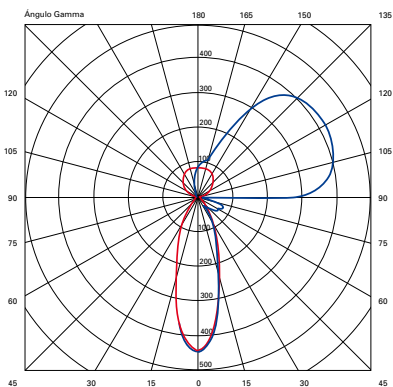

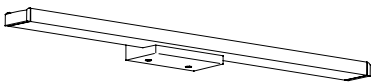

429

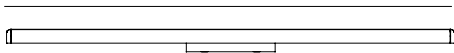

58

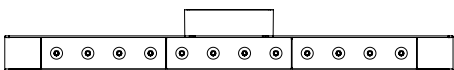
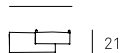

MLN Gil / 6518

Equipo Milan

CR

☐ 429 | H 21 | S 58

3 x LED D.O.B.  4,4 W | 400 lumens (x3)

3.000K | Ra 80 |  Dim | EEI: **A**



MLN Gil / 6519

Equipo Milan

BL

☐ 429 | H 21 | S 58

3 x LED D.O.B.  4,4 W | 400 lumens (x3)

3.000K | Ra 80 |  Dim | EEI: **A**



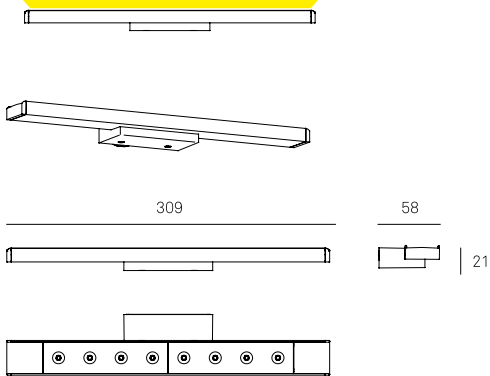
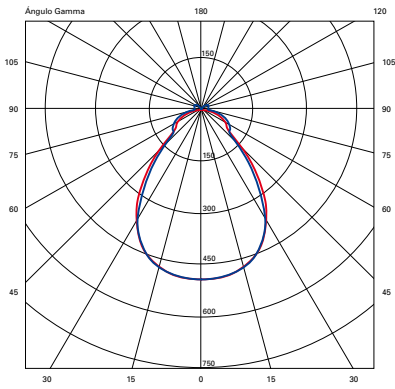

MLN Gil / 6516

Equipo Milan

CR

309 | H 21 | S 58

2 x LED D.O.B. 4,4 W | 400 lumens (x2)

3.000K | Ra 80 | Dim | EEI: A



MLN Gil / 6517

Equipo Milan

BL

309 | H 21 | S 58

2 x LED D.O.B. 4,4 W | 400 lumens (x2)

3.000K | Ra 80 | Dim | EEI: A



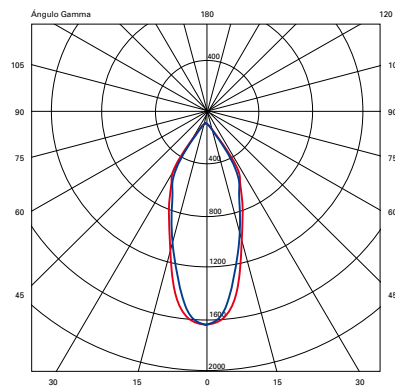
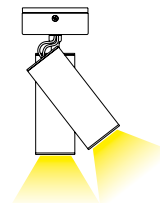
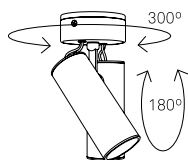
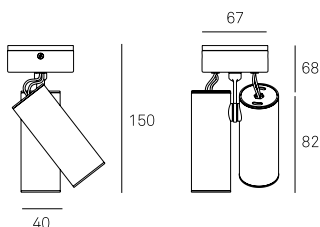
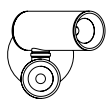

MLN Tub Led / 6328

Stefan Kährs

Al | NE

Ø 90 | H 150

2 x LED PCB AC | 4 W | 300 lumens (x2)

3.000K | Ra 80 | 35°

Dim. | EEL: **A+**

MLN Tub Led / 6329

Stefan Kährs

BL

Ø 90 | H 150

2 x LED PCB AC | 4 W | 300 lumens (x2)

3.000K | Ra 80 | 35°

Dim. | EEL: **A+**

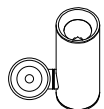
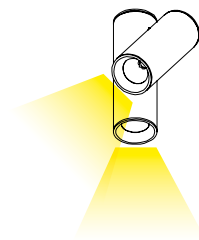
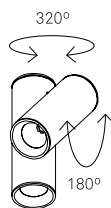
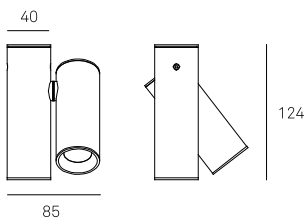



MLN Tub Led / 6508



Stefan Kährs

Al | NE

Ø 85 | H 124

2 x LED PCB AC  | 4 W | 300 lumens (x2)

3.000K |  35° | Ra 80

 |  |  Dim. | EEL: A+

MLN Tub Led / 6509

Stefan Kährs

BL

Ø 85 | H 124

2 x LED PCB AC  | 4 W | 300 lumens (x2)

3.000K |  35° | Ra 80

 |  |  Dim. | EEL: A+

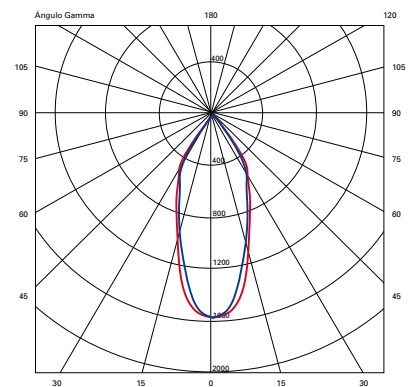

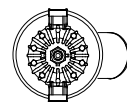
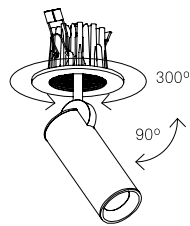
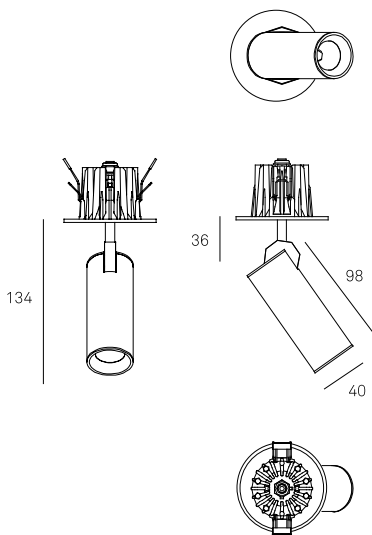

MLN Tub Led / 6514

Stefan Kährs

AI | NE

Ø 85 | H 134

1 x LED PCB AC | 4 W | 300 lumens (x1)

3.000K | 35° | Ra 80

60x60

MLN Tub Led / 6515

Stefan Kährs

BL

Ø 85 | H 134

1 x LED PCB AC | 4 W | 300 lumens (x1)

3.000K | 35° | Ra 80

60x60

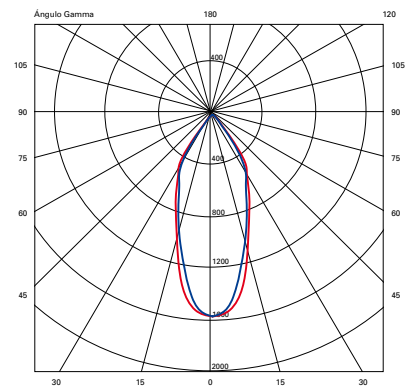
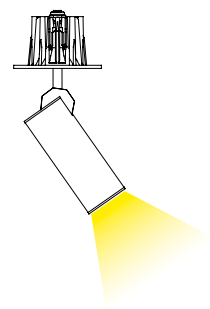



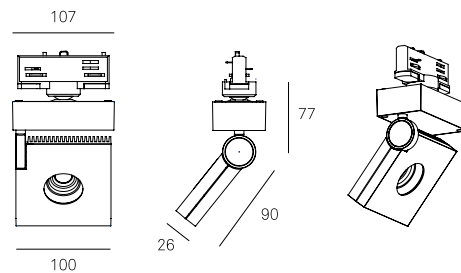
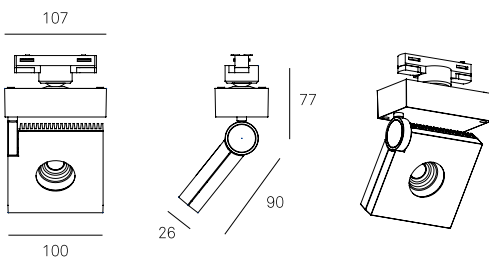
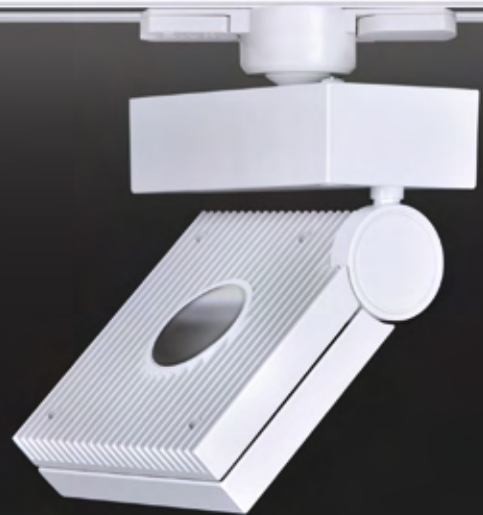

MLN Bridge / 6520

Equipo Milan

BL

Ø 100 | H 90

1 x LED C.O.B. | 10 W | 1010 lumens (x1) | 350mA

3.000K | Ra 80 | \sphericalangle 50° | | EEI: **A+**

| | DRV. INC | Mc. Adams: 3 | |

MLN Bridge / 6521

Equipo Milan

BL

Ø 100 | H 90

1 x LED C.O.B. | 10 W | 1010 lumens (x1) | 350mA

3.000K | Ra 80 | \sphericalangle 50° | | EEI: **A+**

| | DRV. INC | Mc. Adams: 3 | |

MLN Bridge / 4520

Equipo Milan

BL

Ø 100 | H 90

1 x LED C.O.B. | 10 W | 1010 lumens (x1) | 350mA

3.000K | Ra 80 | \sphericalangle 50° | Dim. TR.E | EEI: **A+**

| | DRV. INC | Mc. Adams: 3 | |

Under request

MLN Bridge / 4521

Equipo Milan

BL

Ø 100 | H 90

1 x LED C.O.B. | 10 W | 1010 lumens (x1) | 350mA

3.000K | Ra 80 | \sphericalangle 50° | Dim. TR.E | EEI: **A+**

| | DRV. INC | Mc. Adams: 3 | |

Under request

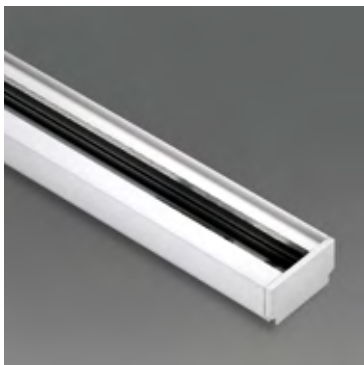

1P Monophasic Track
Accessories



3P Triphasic Track
Accessories

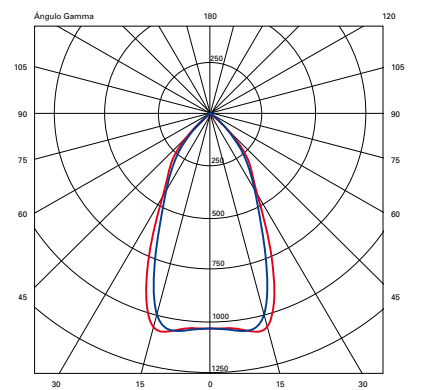
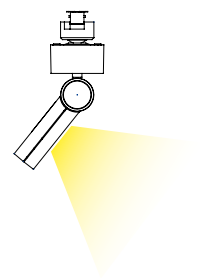

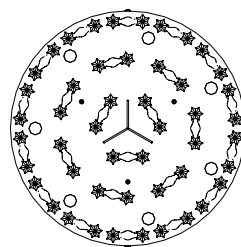
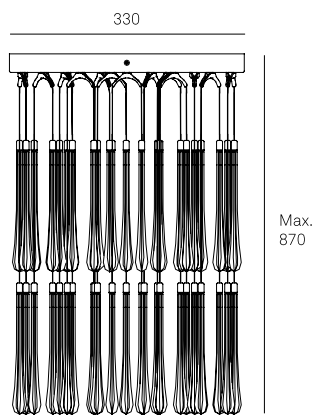
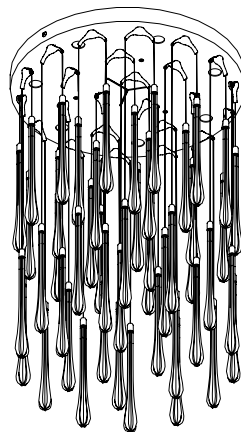

MLN Lacrima / 6535

Jordi Jané

BL

Ø 330 | H Max. 870

7 x LED D.O.B. | 6 W. | 480 lumens (x7)

2.900K | Ra 80 | Dim. | EEI: A

⊕ | ▽ | Mc. Adams: 3 | LM70

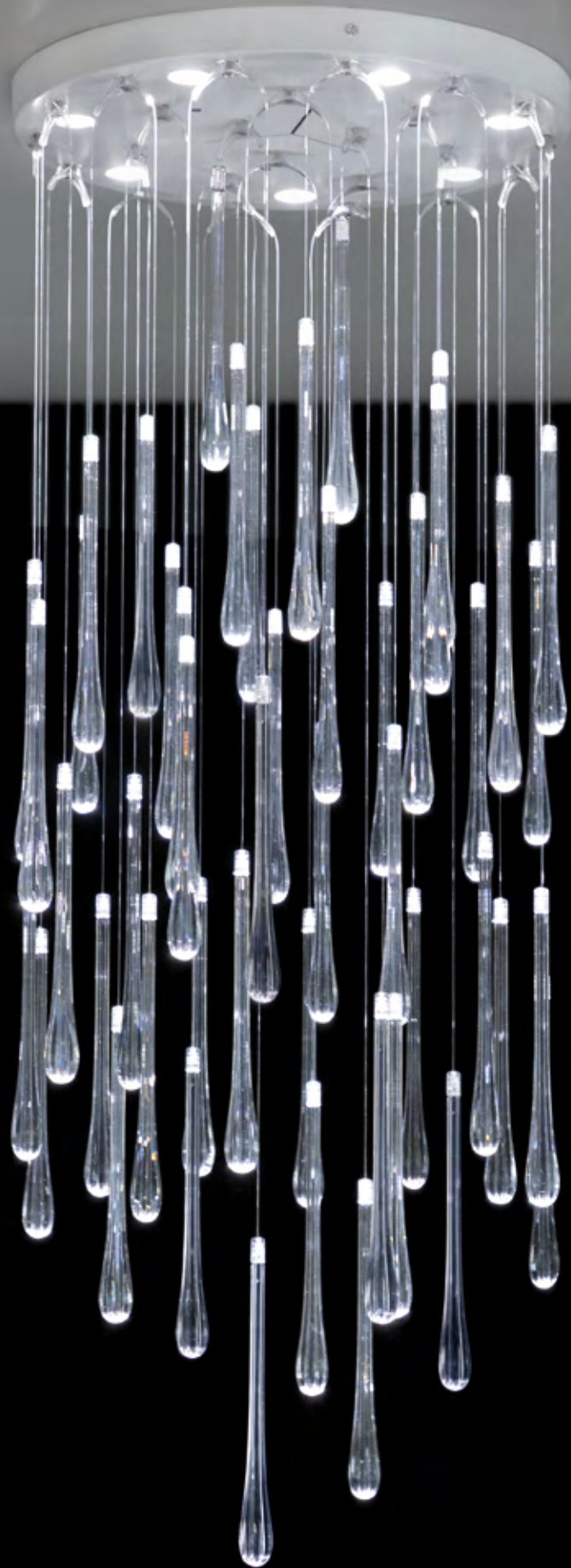

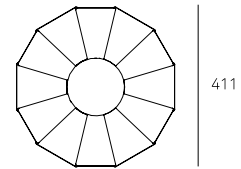
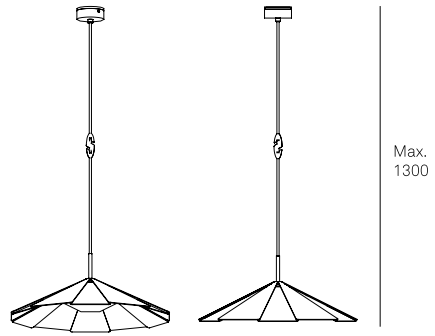

MLN Pam / 6528

Jordi Jané

BL

Ø 411 | H Max. 1300

1 x LED D.O.B. Ⓢ 16 W

1400 lumens (x1) | 3.000K

Ra 80 | ☾ Dim | EEI: A+



MLN Pam / 6529

Jordi Jané

LC

Ø 411 | H Max. 1300

1 x LED D.O.B. Ⓢ 16 W

1400 lumens (x1) | 3.000K

Ra 80 | ☾ Dim | EEI: A+

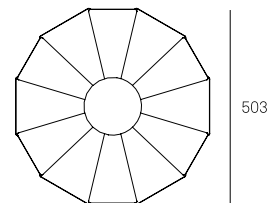
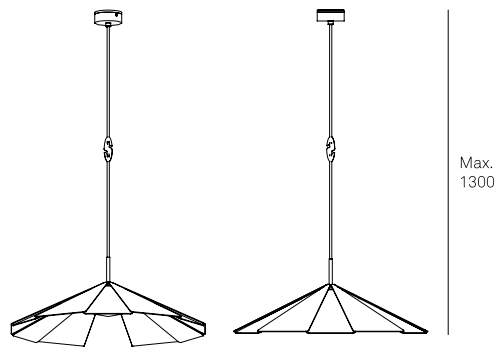

MLN Pam / 6530

Jordi Jané

BL

Ø 503 | H Max. 1300

1 x LED D.O.B. Ⓢ 16 W

1400 lumens (x1) | 3.000K

Ra 80 | ☾ Dim | EEI: A+



MLN Pam / 6531

Jordi Jané

LC

Ø 503 | H Max. 1300

1 x LED D.O.B. Ⓢ 16 W

1400 lumens (x1) | 3.000K

Ra 80 | ☾ Dim | EEI: A+

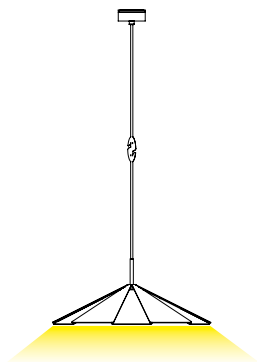
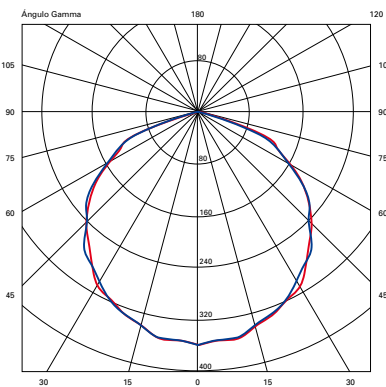

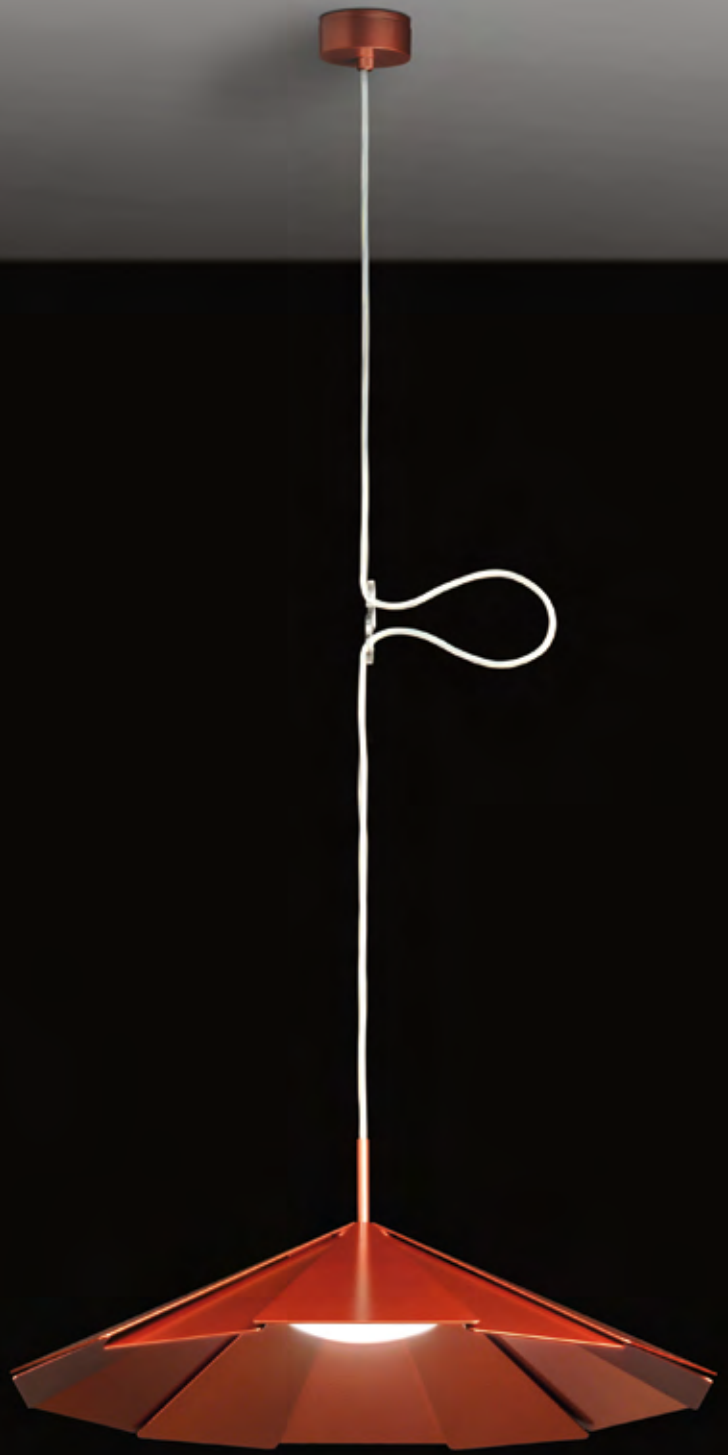

Arquímedes 24
08097 Hospitalet de Llobregat
Barcelona / Spain
T. +34 93 336 99 66
F. +34 93 336 99 60
www.milan-iluminacion.com